

Includes **2005 Guide to Consultants**

June/July 2005

Resource



Engineering & Technology for a Sustainable World

**Sensors for Soil Moisture
in Residential Irrigation**

**Benefits of Attending
the Annual Meeting**

Imagine an integrated compendium of **SIXTEEN** ENCYCLOPEDIAS:

- EARTH AND ATMOSPHERIC SCIENCES
- MATHEMATICAL SCIENCES
- BIOLOGICAL, PHYSIOLOGICAL, AND HEALTH SCIENCES
- SOCIAL SCIENCES AND HUMANITIES
- PHYSICAL SCIENCES, ENGINEERING AND TECHNOLOGY
- CHEMICAL SCIENCES ENGINEERING AND TECHNOLOGY
- WATER SCIENCES, ENGINEERING AND TECHNOLOGY
- ENERGY SCIENCES, ENGINEERING AND TECHNOLOGY
- ENVIRONMENTAL AND ECOLOGICAL SCIENCES AND MANAGEMENT
- FOOD AND AGRICULTURAL SCIENCES AND ENGINEERING
- HUMAN RESOURCES POLICY AND MANAGEMENT
- NATURAL RESOURCES POLICY AND MANAGEMENT
- DEVELOPMENT AND ECONOMIC RESOURCES
- INSTITUTIONAL AND INFRASTRUCTURAL RESOURCES
- TECHNOLOGY, INFORMATION AND SYSTEM MANAGEMENT RESOURCES
- REGIONAL SUSTAINABLE DEVELOPMENT REVIEWS

dedicated to the health, maintenance, and future of the web of life on planet Earth, focusing on the complex connections among all the myriad aspects from natural and social sciences through water, energy, land, food, agriculture, environment, biodiversity, health, education, human rights, poverty, human settlement, culture, engineering and technology, vulnerability analysis, management, and development to environmental security!

THE LARGEST ON-LINE PUBLICATION CARRYING KNOWLEDGE
FOR OUR TIMES

ENCYCLOPEDIA OF LIFE SUPPORT SYSTEMS (EOLSS)

(A virtual dynamic library equivalent to 200 volumes)

WITH CONTRIBUTIONS FROM THOUSANDS OF SCHOLARS,
FROM OVER 100 COUNTRIES AND EDITED BY OVER 300 SUBJECT EXPERTS

Institutional libraries are invited to register at www.eolss.net
using the promotional code "PA17452" to obtain **free trial access** for 5 months.

EOLSS-online is made available free of charge through the UNESCO to universities in the
UN list of least developed countries and disadvantaged individuals worldwide.



Resource

Engineering and Technology for a Sustainable World

Vol. 12 No. 5

June/July 2005

FEATURES

4 Residential Irrigation Based on Soil Moisture

Landscape water use is under close scrutiny at the University of Florida's Agricultural and Biological Engineering research site. Homeowners typically over-irrigate to fulfill lush-green-lawn dreams. With water resources ebbing lower as urban areas grow, the University of Florida team investigates technologies that log data and provide feedback to irrigation systems. In short, monitoring soil moisture conditions means conservation.

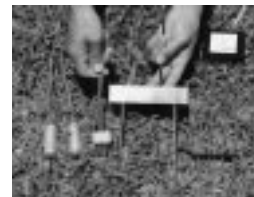

page 4

AE50 Awards

Winners of the 2005 *AE50* competition are in the spotlight. In this special section of *Resource*, a photo and a brief description celebrates each award-winning product.



Guide to Consultants

Our annual listing of professional engineers and engineering firms is inserted in the center of the magazine. Pull out your 2005 *Guide to Consultants* and save it for handy, future reference.

DEPARTMENTS

Update	3	Last Word	19
Personnel Service	17		

ON THE COVER



Each year we eagerly await the *AE50* competition, recognizing companies that produce the best and the brightest — the machines, components, and systems that improve and enhance agricultural, biological, food, and related industries. *Congratulations!* to the 2005 award-winners who introduced their products in the marketplace during 2004. *Applause, applause!* for the creativity and high-tech mind- and manpower that inspired and enabled each recipient.



Benefits of Attending the Annual Meeting

- 7 ASAE President Jerry Wille discusses the benefits he has personally received from attending ASAE annual meetings. As you evaluate your opportunities for professional involvement and development, consider attending this year's ASAE Annual International Meeting in Tampa, Fla.

Centennial Salutations ... and Solicitations

Please send your recollections, reflections, and visions of the future to be used prior to and at the ASAE 100th anniversary in 2007.

All contributions will be preserved in the history files at ASAE. Some will be used in *Resource*, some on the Internet, and some at the anniversary festivities.

Have you got an intriguing question or some pertinent information concerning ASAE's history? Perhaps a vision-casting hunch about what lies ahead in agricultural and biological engineering?

Send your material – 100 to 2,000 words – to hull@asae.org or 2950 Niles Road, St. Joseph, MI 49085-9659. Thank you in advance as we prepare to celebrate the past and anticipate the future.

Advertisers Index

EOLSS PUBLISHERS CO. LTD. inside front cover

Resource reaches nearly 9,000 of the most influential agricultural and biological engineers in the United States, Canada, and more than 90 countries worldwide. To reach this audience with your advertising message, contact Pam Bakken, Advertising Sales Manager, *Resource: Engineering & Technology for a Sustainable World*, 2950 Niles Road, St. Joseph, MI 49085-9659 USA; 269-428-6337, fax 269-428-6329, bakken@asae.org. A media kit is available at www.asae.org/resource/media.html.

Do you have an opinion?

Why not share it? *Resource* seeks timely and thought-provoking op/ed articles for "Last Word" on a regular basis. Express yourself on a topic of interest to the readership! Contact me with ideas, suggestions, and rough drafts, and thanks for reading *Resource*.



Sue Mitrovich, *Resource* Features Editor
2950 Niles Road, St. Joseph, MI 49085-9659 USA
269-429-0300, ext. 313 mitro@asae.org

Resource

Engineering & Technology for a Sustainable World

VOL. 12 NO. 5

AMERICAN SOCIETY OF AGRICULTURAL ENGINEERS

Resource: Engineering & Technology for a Sustainable World (ISSN 1076-3333) (USPS 009-560) is the membership publication of ASAE — the Society for engineering in agricultural, food, and biological systems. The Society is a not-for-profit professional and technical organization of members worldwide interested in engineering knowledge and technology for food and agriculture, associated industries, and related resources. The magazine maintains executive, editorial, subscription, and advertising offices at ASAE headquarters, 2950 Niles Road, St. Joseph, MI 49085-9659, USA; 269-429-0300, fax 269-429-3852, hq@asae.org.

Magazine staff: Donna Hull, Publisher, hull@asae.org; Sue Mitrovich, Features Editor, mitro@asae.org; Suzanne Howard, *Inside ASAE* and Update Editor, howard@asae.org; Pam Bakken, Advertising Sales Manager and Production Editor, bakken@asae.org.

Editorial Advisory Board: Chair Anissa D. Morton, Enviro Ag Engineering Inc.; Vice Chair Edward C. Martin, University of Arizona; Secretary Suranjan Panigrahi, North Dakota State University; Wayne Coates, University of Arizona; Jeremiah D. Davis, Iowa State University; Donald M. Edwards, Retired; Fouad Jaber, University of Florida; Mark R. Riley, University of Arizona; Alan G. Van Nahmen, Farm Buddy; Wade W. Yang, Alabama A&M University; and Joseph M. Zulovich, University of Missouri.

A subscription to *Resource: Engineering & Technology for a Sustainable World* is included in the annual ASAE membership dues. Annual nonmember subscription rates are \$80 including postage in the United States. Add \$25 for postage outside the United States. Overseas airmail rates available on request. Single issues are available

for \$5.50 for members, \$7.50 for nonmembers. Contact ASAE order department, 269-428-6325. An application for membership can be obtained by contacting ASAE.

Change of address: Send recent mailing label and address with ZIP code. Allow four weeks for change to become effective.

Postmaster: Send address changes to *Resource*, 2950 Niles Road, St. Joseph, MI 49085-9659, USA. Periodical postage is paid at St. Joseph, MI, USA, and additional post offices.

Permission to reprint articles available on request. Reprints, in black and white or color, can be ordered in large quantities for a fee. Contact Donna Hull, 269-428-6326. Electrostatic reprints of individual articles, issues, or entire volumes may be purchased from University Microfilms, Box 1346, Ann Arbor, MI 48106, USA; 800-521-0600.

Statements in this publication represent individual opinions. *Resource: Engineering & Technology for a Sustainable World* and ASAE assume no responsibility for statements and opinions expressed by contributors. Views advanced in the editorials are those of the contributors and do not necessarily represent the official position of ASAE.

Copyright 2005 by American Society of Agricultural Engineers.

ASAE officers: Jerry L. Wille, President; Otto J. Loewer, President-elect; Robert J. Gustafson Past President; Ronald L. McAllister, Treasurer; M. Melissa Moore, Executive Vice President.

ASAE council chairs: Kenneth L. Hellevang, Meetings Chair; Gary A. Anderson, Membership Development Chair; Dwayne R. Edwards, Publications Chair; James A. Lindley, Standards Chair.

American Society of Agricultural Engineers

2950 Niles Road
St. Joseph, MI 49085-9659, USA
269-429-0300, fax 269-429-3852
hq@asae.org, www.asae.org



Genetically modified rice benefits health of Chinese farmers

Farmers growing genetically modified rice in field trials in China report higher crop yields, reduced pesticide use, and fewer pesticide-related health problems, according to a study by researchers in China and at the University of California, Davis, and Rutgers University.

“This is the first study to document that genetically modified rice has positive impacts on rice productivity and farmer health,” says study co-author Scott Rozelle, a UC Davis agricultural economist who specializes in China’s agriculture.

“If the world’s largest developing countries adopted agricultural biotechnology products, it could also induce the United States, Canada, and other large agricultural

exporting countries to intensify their commitment to genetically modified crops,” Rozelle adds. “It is possible that rice in China could be the trigger that would revolutionize the world’s agricultural production systems.”

Rozelle and colleagues examined data from field trials involving two genetically modified rice strains: the Xianyou 63 and the Youming 86 variety. The farmers grew the rice without help or advice from technicians and made their own decisions on whether to apply pesticides.

Data from the surveys revealed that the characteristics of the farm households were nearly identical, regardless of what type of rice they were growing.

Results of this study appeared in the April 29, 2005 issue of the journal *Science*. Visit www.sciencemag.org for more information.

Biomass-to-ethanol

Lonnie Ingram, professor at the University of Florida’s Institute of Food and Agricultural Sciences, has developed a biotechnology that converts biomass and other farm wastes into fuel.

His breakthrough technology – a genetically engineered *E. coli* bacteria – produces fuel ethanol from farm waste and biomass such as corn stems, cobs, and leaves; sugarcane residues; rice hulls; forestry and wood wastes; and other organic materials. Ingram says his genetically engineered *E. coli* bacteria is capable of converting sugar types in plant cell walls into fuel ethanol.

Until now, fuel ethanol has been produced from high-value materials such as cornstarch and cane syrup using yeast fermentations. Ingram says his technology will expand ethanol produc-

tion by converting cellulose waste into fuel ethanol.

Ingram says the *E. coli* organisms were genetically engineered by cloning the unique genes needed to direct the digestion of sugars into ethanol, the same pathway found in yeast and higher plants. With the ethanol genes, the engineered bacteria produce ethanol from biomass sugars with 90 to 95 percent efficiency.

“Until we developed this new technology, the chemical makeup of biomass prevented it from being used to make ethanol economically,” Ingram says. “Biomass is a much cheaper source of ethanol than traditional feedstocks but the cost of processing is higher. Energy independence should be the ‘moonshot’ of our generation,” adds Ingram.

For more information, contact Ingram, 352-392-8176.

Water-clarity sensors help track soil loss

Putting a turbidity sensor in crop fields may lead to better monitoring and estimating of soil being lost to water runoff, says ASAE member Seth Dabney. Turbidity is a measure of suspended particles that diminish water’s clarity.

According to Dabney, an agronomist in the Agricultural Research Service Upland Erosion Processes Research Unit at Oxford, Miss., the sensors may enable researchers and farmers to keep continuous records on soil loss.

The optical sensor measures water clarity by using a light beam that scatters when it strikes suspended particles. Similar devices are used for monitoring the cloudiness of storm runoff, wastewater, and waters near construction projects.

Dabney has tested the devices on agricultural fields ranging in size from just under .2 ha (.5 acre) to 16 ha (40 acres), placing 28 of them in pipes that discharge precipitation and irrigation runoff. Stationing them at the outlet of fields gives a far more accurate account of sediment flow than placement in a stream or river, where sediment from

other fields and areas muddles accuracy.

Measuring runoff rate and periodically collecting either a single composite sample or several sequential samples is the typical way to determine soil loss. Use of this high-quality turbidity sensor for the research costs less than collecting and analyzing numerous runoff samples and is less labor-intensive.

Dabney’s study evaluated turbidity measurements as a means of monitoring soil loss and explored procedures for improving the reliability of predictions based on soil and flow characteristics.

For more information, contact Dabney, 662-232-2975, sdabney@msa-oxford.ars.usda.gov.



Severe soil erosion in a wheat field. (Photo by Jack Dykinga, courtesy of USDA-ARS)

Residential Irrigation Based on Soil Moisture

Michael D. Dukes, Bernardo Cardenas-Lailhacar, Grady L. Miller

As urban areas grow throughout the country, limited water resources will be stretched to fulfill urban, agricultural, and other needs. Recent studies in the United States indicate that 58 percent of potable water is used for landscape irrigation. A landscape and irrigation study aimed at determining residential irrigation water use in the Central Florida Ridge found that 62 percent of potable water was used for landscape irrigation during the 29-month monitoring period.

Residential landscape water-use research in Florida found that typical homeowners used an average of 142 mm (5.6 in.) per month. Homeowners using irrigation time clocks, set to seasonal plant-water requirements, used 16 percent less irrigation water on average. Typically, homeowners irrigate too much in the late fall and winter time periods. This often occurs due to lack of knowledge about the necessary length of irrigation times for specific plant material or because it is inconvenient to adjust the irrigation time clock.

As a result, a University of Florida team began looking at technologies that provide feedback to the irrigation system on soil moisture conditions.

In 2004, a research project was initiated at the University of Florida's Agricultural and Biological

Engineering facilities to test several commercially available soil-moisture-based irrigation controllers. The commercially available soil moisture sensors connect to conventional irrigation system time clocks. When the time clock sends a signal to initiate irrigation, the soil-moisture content is checked by the sensor, which has a user-adjustable set-point. If the measured soil moisture is above the set-point, irrigation is not allowed. These sensors are either connected to the last irrigation zone (i.e., valve) for the system or have a time delay so that once irrigation begins, all irrigation zones will receive water. The specific method of measuring soil moisture depends on the manufacturer, but all

Typically, homeowners irrigate too much ... due to lack of knowledge about the necessary length of irrigation times for specific plant material or because it is inconvenient to adjust the irrigation time clock.

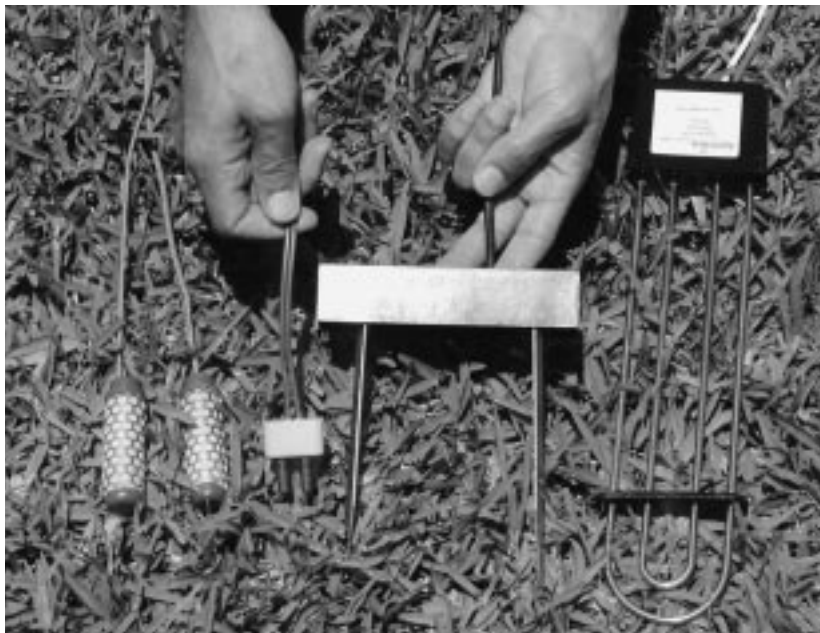

ECH₂O dielectric soil-moisture sensor with HOBO Microstation data logger used to independently monitor soil moisture on the University of Florida's Agricultural and Biological Engineering residential irrigation research project.

of the sensors rely on the ability of the soil to conduct electricity and the correlation of this conductivity with soil moisture.

At the time this project was initiated, the four commercially available controllers were selected for testing. All four sensors are still being tested with three watering frequencies – one, two, and seven days per week between the hours of 4 p.m.

and 10 a.m. The one and two days per week watering frequencies represent typical watering frequencies when watering restrictions are imposed in Florida. The soil-moisture sensors are being compared to a time-based irrigation schedule with a rain sensor (similar to what a homeowner would use) that is set based on historical evapotranspiration (ET), a time-based treatment with a rain sensor, that is 60 percent of historical ET, and a historical ET-based irrigation schedule without a rain sensor.



Soil-moisture sensor research plots during establishment at the University of Florida, Gainesville.

(Historical ET is a measure of the turf grass water use and was determined by computing average grass ET based on weather data gathered in Florida over a 52-year time period.) Irrigation frequencies for the soil-moisture-based controllers were set such that the maximum amount of irrigation that could be applied was the same as the historical ET-based irrigation schedule without a rain sensor. In addition,

there is a non-irrigated control treatment.

All experimental treatments are being replicated four times in a completely randomized design for a total of 64 plots. Each turf grass plot is 3.7×3.7 m (12×12 ft) and established with common Bermuda grass (*Cynodon dactylon*). Each plot is sprinkler-irrigated by four quarter-circle pop-up spray heads that are typical in residential irrigation systems. The soil moisture sensor that controls a particular treatment is buried in the center of one of the four replicates.

During initial uniformity testing on the plots, the driest plots were identified for placement of the soil moisture sensors, according to recommendations by most of the manufacturers. All of the sensors remain placed in the top 7 to 10 cm (3 to 4 in.) of the soil, which is the densest portion of the turf grass root zone.

Pulse-type positive displacement flowmeters are used to continually measure irrigation volume to each plot. Turf quality measurements are conducted by a visual rating system no less frequently than seasonally. Independent soil moisture measurements are collected

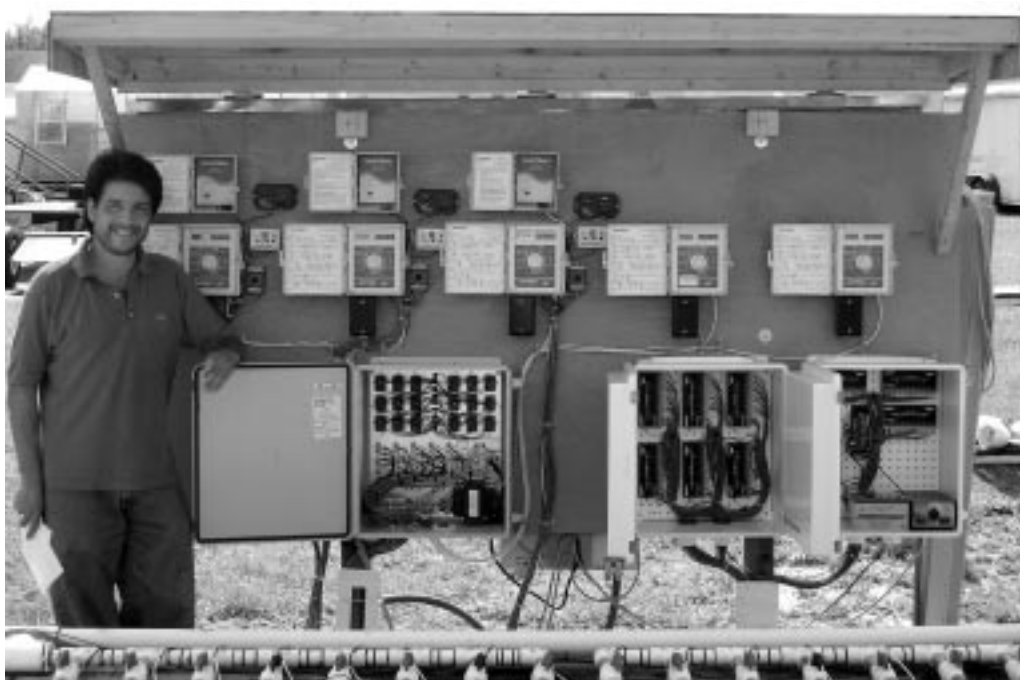

Graduate student Bernardo Cardenas-Lailhacar with soil moisture sensor control systems and monitoring equipment at the research site.

from each plot by ECH₂O (Decagon Devices, Inc., Pullman, Wash.) capacitance-based soil-moisture probes.

The experimental site was fully operational in late July 2004. Irrigation and turf grass quality data were collected through mid-December 2004, when the turf grass became dormant and irrigation was stopped for the winter. Irrigation

water use ranged from 57 mm (2.2 in.) on the lowest sensor-based treatment to 471 mm (18.5 in.) on the highest sensor-based treatment. All soil-moisture sensor-based treatments averaged 205 mm (8.1 in.) of irrigation water. These values compare to 328 mm

(12.9 in.), 495 mm (19.5 in.), and 696 mm (27.4 in.) on the three timer schedules from most to least conservative. Thus, the soil-moisture sensors have saved from 5 to 88 percent and an average of 59 percent compared to the well-managed nonsensor system (time clock set according to historical ET with a rain sensor). However, through



Cardenas-Lailhacar and Dukes check flowmeters used to monitor irrigation volume applied to turf grass research plots.

Thus, the soil moisture sensors could be expected to save a substantial amount of water.

Currently, the cost of available soil-moisture sensor-based controllers ranges from \$75 to \$350. In areas where the cost of water is relatively high, the devices could pay for themselves in a year or less as a result of water savings. As Florida's population and accompanying residential communities continue to expand, there will be an even greater drain on existing freshwater supplies. Soil moisture sensors are an inexpensive and effective way to conserve this important resource.

Dukes with data logger used to record soil-moisture data from the turf grass research plots.

The second phase of this project will demonstrate the technology on homes in southwest Florida. Similar devices have been successfully demonstrated to reduce irrigation water on sweet corn in Florida. Commercially available soil-moisture controllers and a custom soil-moisture-based controller developed at the University of Florida's Agricultural and Biological Engineering Department are also being tested on vegetables – squash, tomato, and green bell pepper – grown in plastic-mulched drip-irrigated production beds. **R**

ASAE member Michael D. Dukes is assistant professor, Agricultural and Biological Engineering, University of Florida, 107 Frazier Rogers Hall, PO Box 110570, Gainesville, FL 32611-0570 USA; 35-392-1864 ext. 107, fax 352-392-4092, mddukes@ufl.edu.

Bernardo Cardenas-Lailhacar is a graduate research assistant, Agricultural and Biological Engineering, University of Florida, 222 Frazier Rogers Hall, PO Box 110570, Gainesville, FL 32611-0570 USA; 352-392-1864 ext. 222, fax 352-392-092, bernardc@ufl.edu.

Grady Miller is associate professor and undergraduate and graduate coordinator, Turf grass - Environmental Horticulture, POB 110670, 2541 Fifield Hall, University of Florida, Gainesville, FL 32611-0670 USA; 352-392-1831 ext. 375, fax 352-392-3870, gmiller@mail.ifas.ufl.edu.

The authors would like to thank the Pinellas-Anclote River Basin Board of the Southwest Florida Water Management District, the Florida Nursery Growers and Landscape Association, and the Florida Agricultural Experiment Station for their support of this project.

Currently, the cost of available soil-moisture sensor-based controllers ranges from \$75 to \$350 ... the devices could pay for themselves in a year or less as a result of water savings.

most of this time period, turf grass quality on the non-irrigated plots was similar to the irrigated plots. This observation indicates that irrigation in the late summer and most of the fall was not necessary to maintain acceptable turf grass quality due to 944 mm (37.2 in) of rainfall during this period. It is useful to note that regardless of irrigation need, most homeowners would have some type of irrigation schedule programmed into their time clocks.

Inside ASAE

NEWS ABOUT THE SOCIETY AND ITS MEMBERS

2005 Annual International Meeting

8 Meeting Offers Many Activities; CPD Courses Highlight Annual International Meeting; Catlett to Headline Keynote; Tours, Tours, Tours; Area Hotels Prepare for Ag/Bio Engineers; Northwest Airlines Provides Discounted Airfares to Tampa; What You Don't Know About ASAE; Everyone Welcome at the Foundation Fun Day; Going Once ... Going Twice ... Sold to the Highest Bidder!

Preprofessionals

11 Southeast Regional Rally, "The Road to Raleigh," Deemed a Success

Want to Get Your Company Noticed? ASAE Can Help

11

Section News

12 Minnesota Section Activities

2005 ASAE Nominating Committee Seeks Input

12

Call for Nominations for 2006 ASAE Awards

13

Standards

14 Electronic Milestone Reached for Standards Development; Cooperative Standards Program

In Memoriam

14 John R. Carreker

Member News

15 Merlin N. Nelson
Lindsay N. Birt

Welcome New Members

15

Events Calendar

16

Benefits of Attending the Annual Meeting

I was recently asked why I was willing to donate time to ASAE, and what did I receive from it? The answers are quite simple. I am happy to repay all that ASAE has provided me with a little bit of my time. My consulting firm would not have survived without ASAE and the contacts it has provided personally and professionally. Those contacts have been made and nurtured through numerous section meetings, conferences, and annual meetings. Too many times people join ASAE or a similar organization expecting to instantly change their professional knowledge or improve their business without taking an active role or participating in programs.

As we approach another Annual International Meeting, I would encourage you to think about the benefits of attending. The information transfer at the technical and poster sessions provides both the planners and the participants the ability to develop and maintain technical competency. The various poster sessions in particular provide an opportunity to discuss specific details and how those details may relate to the design challenges you may or will eventually be facing in your business. With the rapid technical growth in our current industry, sessions of this type provide the opportunity to increase or maintain the proficiency expected by existing and potential clients as well as employers. Similarly, the continued professional development (CPD) courses provide not only the ability to maintain technical competency, but also supply the continuing education units many of us need for our professional engineering licensure. The CPD courses are most closely related to my normal design projects. These programs are far more economical than any other continuing education programs endorsed or hosted by other organizations I have attended.

ASAE has frequently been identified as having a disproportionately large number of committee meetings. However, this large selection of technical committees has provided me the opportunity to help in the writing of standards that we frequently use in our designs, to plan future programs related to my design interest, and to network with people in similar disciplines. Though my participation and utilization of materials developed through ASAE is beneficial, nothing can equal the acute awareness I have received while helping to prepare those materials.

The awards luncheon program obviously provides recognition and a pat on the back for recipients, but in addition to that, I feel that I benefit from the opportunity to see and be a part of the celebration of the people who have distinguished themselves in the same career I have chosen. I always leave the luncheon with a feeling of pride and a desire to achieve a higher goal personally and in our chosen field of expertise.

ASAE hosts numerous social and networking activities at the Annual International Meeting – from the family night barbeque to technical tours and alumni breakfasts. These activities and other similar events provide attendees opportunities to meet and get to know people with similar professional and social interests. These networking opportunities provide personal development and establish relationships which are invaluable. These relationships are so strong for me personally that I know many of my ASAE associates would assist me in any way they could regardless of the personal or technical nature of the problem. Seven of the last eight engineers on our staff were located by contacting an ASAE member for help in locating new employees. Potential solutions to technical problems are frequently just a phone call away when a professional and social rapport has been established.

I have attended every meeting for the past 32 years and have always left with the feeling that I received a tremendous benefit. As you evaluate your opportunities for professional involvement and development, I would encourage you to consider attending the ASAE Annual International Meeting. I am confident that you will find ASAE's meetings and conferences a wonderful venue for supporting the agricultural and biological profession, expanding personal technical expertise, and networking with great people like yourself.

I have attended every meeting for the past 32 years and have always left with the feeling that I received a tremendous benefit. As you evaluate your opportunities for professional involvement and development, I would encourage you to consider attending the ASAE Annual International Meeting. I am confident that you will find ASAE's meetings and conferences a wonderful venue for supporting the agricultural and biological profession, expanding personal technical expertise, and networking with great people like yourself.

ASAE President, Jerry L. Wille, Curry-Wille & Associates

2005 ANNUAL INTERNATIONAL MEETING

Meeting Offers Many Activities

With diverse technical sessions and tours, a dynamic keynote presentation, and a broad selection of timely continuing education opportunities, the 2005 ASAE Annual International



The Convention Center overlooks the Tampa Bay waterfront. (Photo courtesy of Tampa Convention Bureau)

Meeting has a lot to offer attendees. Add to all that the meeting's location in Tampa, Fla., and an extensive offering of cultural, sightseeing, and family activities, and this meeting becomes a fabulous opportunity for a family vacation.

New to the meeting this year is an exciting and different format for the division poster sessions. All poster presentations within each division will be in one time slot specifically promoted as a division session. During this particular time, technical sessions for the same division will not be scheduled to allow all participants the opportunity to participate in the poster session.

The 2005 ASAE Annual International Meeting is one you don't want to miss. There promises to be plenty of activities to keep you abreast of the latest technology, opportunities to network, and many exciting things to do. Make plans now to attend the ASAE Annual International Meeting in sunny Tampa. For the latest updates on the meeting, visit www.asae.org/meetings/am2005/index.html.

CPD Courses Highlight Annual International Meeting

Eleven continuing professional development courses are scheduled for this year's meeting. They include:

- Biology Meets Engineering – An Overview of the Everglades Construction Project
- Grid Computing for Computationally Intensive Problems
- Optical Systems for Agriculture
- Hyper-spectral and Multi-spectral Imaging
- Application of Watershed Models
- Virtual Engineering of Animal Confinement Facilities
- Instructional Design Methodology and Learning Objects
- Professional Engineering Exam Review
- Incident at Morales, an Engineering Ethics Story
- AFO PRO Training – Animal Feeding Operations Software Program
- Methodology for Evaluating Changes in Phosphorus Load Due to Land Use Changes

Register now and get more out of the Annual International Meeting by earning professional credit hours toward your recertification. If you are not registered, do it today to reserve your place.

Catlett to Headline Keynote

This year's keynote speaker is futurist Lowell Catlett. As a consultant to the U.S. Departments of Agriculture, Interior, Defense, and Labor as well as a professor at New Mexico State University, Catlett brings to his presentations an understanding of evolving technologies and their implications for society.



Tours, Tours, Tours

Adding to your Tampa experience, there are five technical tours and 10 leisure tours/events offered for meeting attendees. Whether for insight and education or just plain relaxation, there is a wide variety of options available to keep you and your family entertained.

If you are interested in the technical side of Tampa Bay and the surrounding areas, sign up for one or more of our technical tours which target your profession. They include a rambling ecotour of a Florida ranch; a tropical aquacultural laboratory plus a visit to a fish farm; Food Technologies Services, Inc. – a food irradiation plant; a nurseries tour; and a dairy tour.



The Tampa skyline beckons meeting attendees to Tampa. (Photo courtesy of Tampa Convention Bureau)

When you take a break from the meeting – or to keep your family entertained while you're attending technical sessions, sign up for our leisure tours, which are sure to provide something for everyone with a wide variety of 10 excursions. Included are a Foundation golf outing at Eagles

Golf Club of Tampa Bay; Florida winery and wine class with lunch; Young Professional/Preprofessional comedy club and dinner; dinner dance at the Florida Aquarium; Tampa city tour; canoeing; Lowry Park Zoo with a behind the scenes tour; Tarpon Springs; St. Petersburg city tour; and Splitsville – "It's Not your Daddy's Bowling Alley."

Be sure to add these tours and events to your meeting registration. If you have already submitted your registration and missed one of these great opportunities, give us a call and we can add it for you. Reserve your spot today, as registration is limited!

2005 ANNUAL INTERNATIONAL MEETING

Area Hotels Prepare for Ag/Bio Engineers

Final preparations including hotel reservations are being made for the Annual International Meeting. ASAE has three great hotels with a low conference rate of \$119 per night waiting for you in Tampa, Fla. If you haven't already made your reservations, don't wait.

Tampa Marriott Waterside is a new convention service hotel overlooking beautiful Tampa Bay. The hotel has many amenities and is within walking distance to the Tampa Convention Center, the Florida Aquarium, and various shops, restaurants, and entertainment. The Tampa Marriott Waterside is a beautiful location to extend your convention stay with Gulf Coast beaches just a short drive away. In addition, nearby Busch Gardens and Adventure Island make for great family fun. Call 800-583-0179 to secure your room today. Be sure to tell them you are with ASAE to receive the discounted room rate.



Hyatt Regency Tampa's fresh new look can be the inspiration for your visit to Tampa. Located in the heart of the financial and arts districts, you'll find yourself immersed in relaxing surroundings with exceptional service. With three restaurants this facility provides for unique dining experiences. Hyatt Regency Tampa is located near the Franklin Street Pedestrian Mall and convenient to the Tampa Bay Performing Arts Center, three museums, four art galleries, and the Tampa Convention Center. To reserve your room call 800-233-1234. Let them know you're with ASAE to receive the group discounted rate.



Wyndham Harbour Island Hotel is surrounded by lush tropical landscaping and rests on its own tranquil island – yet it is just minutes from downtown Tampa, the Convention Center, and Tampa International Airport. At the Wyndham Harbour Island Hotel you'll enjoy a quaint harbor view from your guest room full of special touches. You can dine at the refreshing Luna di Mare or enjoy the many other amenities of this beautiful property. The Wyndham Harbour Island's delightful neighborhood is full of wonders to explore and only minutes from the great activities Tampa has to offer. Book your room today at 813-229-5000. Be sure to tell them you are with ASAE to receive the special rate.



Book your rooms soon with one of these hotels. Special rates are coordinated by ASAE as a member courtesy. The Marriott has been designated as the headquarters hotel, but space is limited. Government and student rates are available, but each person must have a valid identification to qualify.

ASAE is proud to announce their new partnership with Northwest Airlines, KLM, and the Northwest Airline partners to provide discounted airfare on both domestic and most international flights to Tampa for the Annual International Meeting, July 17-20, 2005.

Northwest Airlines Provides Discounted Airfares to Tampa

ASAE members may receive discounted rates of up to 10 percent off a variety of fares or 5 percent off of any "promotionally advertised" or "short term" sale fares that are offered to/from North America and Europe or to/from North America and Asia.

With this agreement, ASAE has provided a window for travel between July 7 and July 29 to allow members extra vacationing time in the Tampa/St. Petersburg areas while still benefiting from the discount. ASAE members may receive discounted rates of up to 10 percent off a variety of fares or 5 percent off of any "promotionally advertised" or "short term" sale fares that are offered to/from North America and Europe or to/from North America and Asia.



How the Program Works

- North American participants should call Northwest/KLM at 800-328-1111 during normal business hours.
- All calls must refer to the WorldFile/ticket designator "RBASR" to obtain information or reserve seats for this program as well as receive the designated program discount.
- Attendees from Europe, Asia, and Africa may call the Northwest/KLM reservations office in their country of origin.
- Tickets may be purchased from Northwest, KLM, or any appointed travel agent.

Disclaimer

Until ticketing occurs, fares are subject to change without notice and are based upon availability at the time of booking. Once ticketed, refer to the applicable fare rule for any changes, re-issues, and cancellations penalties.

ASAE encourages everyone to use this program and would ask that you encourage your peers to also take advantage of this new partnership.

What You Don't Know About ASAE

Are you new to the Society? Maybe you're just new to the Annual International Meeting? Then this session is for you! Hosted by the Young Professional Community, this session will introduce both new and longtime members to the many opportunities available in ASAE for those working in academia, industry, and public service. Topics to be addressed include getting the most out of meetings, ASAE communities, ASAE history, technical and non-technical committees, and the peer-review process. Attend this session on Monday from 7 to 8 a.m. to receive insight on what conferences to attend and how to get the most value out of your membership.

2005 ANNUAL INTERNATIONAL MEETING

Everyone Welcome at the Foundation Fun Day

A day of fun is planned for Saturday, July 16, preceding the 2005 ASAE Annual International Meeting in Tampa, Fla. This year's Foundation Fun Day includes a round of golf and an evening dinner dance at the Florida Aquarium. The day's activities will support the ASAE Foundation and the Society. All ASAE members are welcome and encouraged to participate. Don't miss out! Enjoy a day of socializing!

Enjoy a Round of Golf at the Eagles Golf Club

There's still time to enter yourself or a foursome and hit the links in this Foundation scramble at one of Florida's premier golf courses. Among the favorite courses to play in Tampa Bay, the Eagles Golf Club has a hard-won reputation for well-conditioned tees, greens, and fairways. This golf outing package includes:

- 18-hole championship course
- Saturday morning start
- Box lunches in the carts
- Green fee and cart
- Player gift package
- Trophies and prizes

Cost of the package, including tax and service charges, is \$100 per person (portion tax deductible). Don't miss out on this great opportunity to golf at a championship course that will challenge your golfing skills and help support your Society. Sign up today!



The Eagles Golf Club championship courses are favorites among Tampa Bay golfers. Enter a foursome to play in this Foundation Fun Day golf outing.

Dinner Dance – Florida Aquarium

The Florida Aquarium provides an exciting backdrop for an evening of dining and dancing. Offering more than 10,000 aquatic plants and animals from Florida and beyond, the aquarium tells Florida's unique water story as it follows a drop of water from its underground source to the open sea. Guests will have the opportunity to wander through the aquarium and explore the Florida wetlands, bays and beaches, and coral reef exhibits.



Experience the Florida Aquarium and discover why it ranks among the world's top aquariums.

Cocktails and hors d'oeuvres will be offered from 7 to 8 p.m. Dinner will be served at 8 p.m. in the Coral Reef Room where a panoramic window allows for a spectacular view into the coral reef face. While you enjoy a relaxing dinner, you'll be able to watch blacktip sharks, groupers, yellowtail snapper, and queen triggerfish swim by.

Rounding out the evening will be dancing and additional time to wander through the exhibits. The Florida Aquarium is a short trolley ride from the Convention Center. The cost for the evening is \$90 per person (portion tax deductible).

To register for this fun filled day, go to www.asae.org/meetings/am2005/documents/RegFormAM2-18-05.pdf.

Going Once ... Going Twice ... Sold to the Highest Bidder!

Foundation Silent Auction Bigger than Ever

The Foundation will once again be holding a silent auction at the Annual International Meeting in Tampa, Fla. It promises to be even bigger and better than last year!

The Foundation is raising money for ASAE's 100th Anniversary – to promote recognition of the agricultural and biological profession and ASAE. Your assistance is needed to have sufficient capital to begin programs and activities for this purpose. A donation to the Foundation is an opportunity to affirm your life's work and invest in the future of the profession.

The silent auction items will be on display in the Exhibit Hall, Sunday and Monday from 7 a.m. to 5 p.m. and Tuesday from 7 a.m. until 3 p.m. The auction will take place Tuesday at 3 p.m. Some of the items already donated include: toy tractor equipment and trucks personally autographed sports memorabilia, university logo items, wine, cheese, vacation packages, fishing lures, baskets, quilts, games, books, and gift baskets containing regional items.



The Foundation Challenge to You

The Foundation has issued a challenge to all ASAE sections, universities, companies, and individual members to help make this a successful silent auction. Sections are being asked for items that represent their areas. Suggestions include baskets containing local specialties, free registrations to section conferences and meetings, or sports memorabilia from local teams. University department heads might consider donating university logo items, sports memorabilia, and agricultural and biological publications from university alumni. Companies may wish to provide products or items related to their businesses. In addition, individual members are always welcome and encouraged to donate items to support the Foundation.

Be sure to check out all the great items in the auction and place your bids. Don't miss out on all the fun and excitement and the chance to support your Society!

If you would like to donate to the silent auction, contact Linda Young at 269-429-0300, ext. 306, or young@asae.org.

PREPROFESSIONALS

Southeast Regional Rally, "The Road to Raleigh," Deemed a Success

The North Carolina State student branch went all out to provide a good time, great food, and educational tours for 30 students and eight advisors from Auburn, Georgia, Kentucky, North Carolina A&T, Tennessee, and Virginia Tech, plus 16 students from the North Carolina State branch.

The three-day event provided plenty of fun competition between the schools. The University of Georgia won the scavenger hunt. The University of Kentucky placed first in the Ag Olympics. The Ag Olympics consisted of several innovative events including marshmallow stuffing, fruit bowling and toss, hillbilly horse-shoes, hay stacking, seven letter human scrabble, as well as the usual tug of war.

Tours included Diosynth Biotechnology (RTP, N.C.); Novozymes North America (biotechnology, Franklinton, N.C.);

Aeroglize (drier design and construction, Raleigh, N.C.); a local stream restoration site; and three NC State University facilities:

Extension Fish Barn, Land Application Training and Demonstration Center, and the Animal Waste Management Center Processing Facility.

John Long of North Carolina State presided over the business meeting as regional president. Officers elected for the coming year are President Courtney Fisk of the University of

Kentucky, Vice-President Scott Shore of North Carolina State, Secretary-Treasurer Tiffany Smith of North Carolina A&T, and Parliamentarian Mack Moncus of Auburn. The rally next year will be hosted by the University of Kentucky.

Mari Chinn and Phil Westerman
Student Branch Co-Advisors



These students were part of the fun and activities at the Southeast Regional Rally hosted by North Carolina State.

Want to Get Your Company Noticed? ASAE Can Help

Getting noticed has become an ever increasing challenge for today's businesses. As marketing executives review the numerous and exaggerated cost of today's advertising and the unnecessary dollars spent on the promotion of specific products or services versus the overall return on that investment, I have to cringe – and I'm in the business.

Billions of dollars are spent on numerous print publications, direct mail pieces, electronic advertising, and billboards in the United States alone. I can't help but ask the fundamental question: Are you reaching the right audience? Then add in advertising agencies that, after a lunch meeting, think they understand you, your product, and services – as well as know who you should want as your client. Give us a break. Why are you wasting that money?

I have yet to understand why one solid marketing tool isn't used more efficiently. That's your professional Society. With ASAE you have an organization that can help you build a network that can create and sustain developments and practices to use your products. You build personal relationships to keep your products current with the advanced research and cutting-edge technologies in your industry. You expand the market and gain support for use of your products and services.

So do I have your attention? I bet you're even a little interested in what ASAE can do for your business. ASAE can be the primary tool for you and your company's marketing and promotion. As an ASAE member, discuss with your marketers the benefits you get from peer exchanges and connections that can be made through the numerous ASAE conferences, meetings, and symposiums. Each conference, meeting, or symposium has event functions needing sponsor support. Each offers ample opportunities to build recognition for your company's name, brand, and service and to increase your connections with the new technologies. The next opportunity is the Annual International Meeting in Tampa, July 17-20, 2005. Here are a few examples of company marketing opportunities:

- Product display in exhibit area
- Service information or career opportunity display
- Technical session sponsorship
- Registration badge holders with company identification
- Poster session sponsorship
- Event and function sponsor – Welcome Reception

ASAE would like to show you how we can help build your company's business and product exposure. Contact Wayne Maley, maley@asae.org or Michael Chesser, chesser@asae.org to outline your company's needs. Our staff will work with you to design a package to help drive the results you are seeking.

Michael Chesser, Director of Meetings and Conferences

SECTION NEWS

Minnesota Section Activities

Fifteen members of the Minnesota Section and their guests toured the Phoenix Solutions' plasma system testing facility in Hutchinson, Minn., and the Pioneer Seed Corn Facility in Dassel, Minn., on April 8, 2005.

Gary Hanus, senior vice president of Phoenix Solutions, gave a presentation on high temperature plasma technology and its application in biomass gasification. His staff gave a tour and provided a demonstration of the system.

Chris Beach, Minnesota Section vice chair for membership and research equipment specialist of Pioneer Hi-



Several members of the Minnesota Section including ASAE President Jerry Wille (center) attended tours as part of their section meeting activities held in April.

Bred International, explained Pioneer's activities and gave a tour of that facility.

ASAE President Jerry Wille was welcomed to the section business meeting and tour at the Pioneer Seed Corn Facility. He explained the biological and agricultural subject reviews and PE exam situation. In addition, Wille encouraged section meeting

participants to attend the ASAE Annual International Meeting in Tampa where the new Society name will take effect. He also invited the Minnesota Section to get involved in the 2007 ASAE meeting to be held in Minneapolis, Minn. Roger Ruan led discussion of current section issues in the business meeting.

Roger Ruan
Section Chair

2005 ASAE Nominating Committee Seeks Input

The 2005 ASAE Nominating Committee is seeking well-qualified candidates for the following ASAE offices.

2007-2008 President of ASAE

ASAE presidents are selected in alternate years from the public and private sectors. The nominee selected by this committee will be from the public sector.

Trustees At-Large

Eight nominees will be selected from which four will be elected in early 2006.

Both the president-elect and the four new trustees at-large will join the board after the 2006 annual meeting. The trustees will serve two-year terms ending at the end of the 2008 annual meeting. The president-elect will serve one year as president-elect, one year as president, and one year as past president.

Nominees are also sought for six positions (12 nominees in all) on the 2006 ASAE Nominating Committee. This year's candidates will be selected to represent the following divisions and districts: ESH; SE; International, District 1 (Northeastern United States, Quebec, Ontario, Nova Scotia, and Prince Edward Island); District 3 (Midwestern States); and District 5 (Pacific Northwest, Manitoba, Saskatchewan, and British Columbia).

The committee is soliciting suggestions for nominees for the above positions. Selection of officers and members of the nominating committee is extremely important to the success of

ASAE, and we appreciate your help in identifying well-qualified candidates. You may submit your suggestions to me or any member of the nominating committee listed below.

Members of the 2005 ASAE Nominating Committee are: Henry A. Affeldt, Billy J. Barfield, Cady R. Engler, Conly L. Hansen, Zachary A. Henry, Raymond L. Huhnke, Larry D. Jacobson, Walter J. Rawls, Douglas J. Reinemann, Gary T. Roberson, Philippe M. Savoie, Shahab Sokhansanj, and Kenneth C. Sudduth.

Thanks for your help in this important ASAE activity.

Lyle E. Stephens
2005 Nominating Committee Chair
StephensLyleE@JohnDeere.com

Annual Meeting Updates



For the latest information on the
2005 Annual International Meeting
July 17-20, Tampa, Fla. visit
www.asae.org/meetings/am2005

Call for Nominations for 2006 ASAE Awards

Do you know someone who is an unsung hero or heroine of engineering? Perhaps you know a designer whose products are exceptional or a researcher whose work is the foundation for significant developments. How about that teacher who inspires greatness? Help give them the recognition they deserve.

Nomination deadline is Oct. 31, 2005

- **Cyrus Hall McCormick-Jerome Increase Case Gold Medal.** Honors exceptional and meritorious engineering achievement in agriculture that has resulted in new concepts, products, processes, or methods that advanced the development of agriculture. Gold medal.
- **John Deere Gold Medal.** Honors achievement through engineering for improved manipulation, use and conservation of soil-water resource, and that which has resulted in applications of a new concept, product, art, or science that advanced the development of agriculture. Gold and bronze medal.
- **Massey Ferguson Educational Gold Medal.** Honors those whose dedication to the spirit of learning and teaching in the field of agricultural engineering has advanced our agricultural knowledge and practice and whose efforts serve as an inspiration to others. Gold medal.
- **Henry Giese Structures and Environment Award.** Honors distinguished service in advancing the knowledge and science of agricultural structures and environment. Engraved plaque on a wooden base.
- **Hancor Soil and Water Engineering Award.** Honors contributions to the advancement of soil and water engineering. Contributions may be in teaching, research, planning, design, construction, management, or development of materials. Bronze medallion on a plaque.
- **ASAE Kishida International Award.** Honors outstanding contributions to engineering-mechanization-technological programs of education, research, development, consultation, or technology transfer that have resulted in significant improvements outside the United States. Engraved plaque and \$1,000.

- **G.B. Gunlogson Countryside Engineering Award.** Honors outstanding engineering contributions to the development and improvement of the countryside. Engraved copper plate on a hardwood plaque.
- **NAMIC Engineering Safety Award.** Honors outstanding contributions to research, design, education, or promotion that have advanced agricultural safety engineering. Engraved desk pen set.
- **IAFIS-FPEI Food Engineering Award.** An annual award, alternating between recognition of a *distinguished* food engineer in odd-numbered years, and an *emerging* food engineer with less than 10 years practice in even-numbered years. The award honors original contributions in research, design or development, the management of food processing equipment, or techniques of significant economic value to the food industry and the consumer. Award presented during the International Association of Food Industry Suppliers Annual Conference in the spring with representation at the ASAE Annual International Meeting. Gold medal, certificate, \$2,000 and travel expenses to the IAFIS conference; bronze medal presented at the ASAE annual meeting.
- **Sunkist Young Designer Award.** Honors the development or creation of a technical plan that is materially influencing agricultural engineering progress, as evidenced by use in the field. Bronze medallion on a plaque. Nominee must be under the age of 40 at time of selection.
- **Young Extension Worker Award.** Honors outstanding success in motivating people to acquire knowledge, skills, and understanding to improve agricultural operations. Bronze medallion on a plaque. Nominee must be under the age of 40 at time of selection.
- **New Holland Young Researcher Award.** Honors dedicated use of scientific methodology to seek out facts or principles significant to agricultural engineering. Nominee must be under the age of 40 at time of selection. Engraved bronze medallion on a hardwood plaque.

- **A.W. Farrall Young Educator Award.** Honors outstanding success motivating the application of engineering principles to agricultural engineering problems. Nominee must be under the age of 40 at time of selection. Bronze medallion on a plaque.
- **Mayfield Cotton Engineering Award.** Honors outstanding contributions to the cotton industry. Engraved plaque.
- **National Food and Energy Council Electrification Award.** Honors contributions to the use of electrical energy in the production and processing of agricultural products and to emphasize the unique role of agricultural engineering. Engraved plaque.
- **Robert E. Stewart Engineering Humanities Award.** Honors a graduate or undergraduate student who is a member of ASAE at the time of nomination for outstanding contributions to the profession and humanities. Engraved plaque.
- **Rain Bird Engineering Concept of the Year Award.** Honors an engineer or engineering team for contributions to the development or advancement of a new engineering concept. Engraved plaque.
- **Award for the Advancement of Surface Irrigation.** Recognizes and publicizes efforts that enhance the acceptance and efficient use of surface irrigation methods. Engraved plaque and \$500.
- **Evelyn E. Rosentreter Standards Award.** Recognizes individuals who have given exceptional contributions toward the generation, maintenance, and administration of ASAE standards. Engraved plaque.
- **PEI Professional Engineer of the Year Award.** Recognizes a licensed engineer who has made outstanding contributions to the engineering profession, the public welfare, and/or humankind.

For instructions on how to nominate a colleague and nomination forms, visit www.asae.org/awards/major/major.html. For more information, contact Carol Flautt, 269-428-6336 or flautt@asae.org.

STANDARDS

Electronic Milestone Reached for Standards Development

As the ASAE standards development process continues to shift towards electronic communication, a quiet but significant milestone was just reached.

While many ASAE technical committees have embraced the use of the ASAE Forums, one committee in particular is the leader of the pack.

PM-03, the oversight committee for power and machinery standards development, has posted information or balloted more than 100 distinct Forums entries over the past three and a half years. With approximately 24 members, this is a significant savings in time and resources for ASAE. Each entry would have meant a physical mailing to every PM-03 member. Since the majority of these mailings are ballots, those mailings would have

included a postage-paid return envelope in addition to copies of all the documents.

There is another significant savings that needs to be mentioned and would often be overlooked when discussing the benefits of Forums and electronic communication – compilation of responses. In the past, comments and results from the paper ballots would have required manual transfer to a ballot summary. With the use of Forums, this is electronic and easily transferred. These changes also reduce the overall timeline to develop a standard and allow ASAE staff to handle an increasing amount of standardization activity.

While PM-03 has reached this milestone, it should also be mentioned that

there are dozens of other ASAE committees that frequently use Forums. This is expected to grow and is having a bottom-line impact that is much appreciated!

IN MEMORIAM

ASAE Fellow John R. Carreker, 96, a retired soil and



water specialist who spent his career with the U.S. government, died May 3 in Atlanta, Ga. After working with

the Civilian Conservation Corps, Carreker moved to Athens, Ga. to become the Director of the USDA Southern Piedmont Conservation Research Center in Watkinsville, Ga. He retired from the USDA in 1973, as a research leader for the Southeastern United States.

Carreker earned a master's degree in agricultural engineering in 1933 from Auburn University. He recently wrote an article for *Resource* magazine which was published as the Last Word in the April 2005 issue. The article focused on historical irrigation research and how it still affects sustainable ag worldwide. A 74-year member of ASAE, Carreker was elected ASAE Fellow in 1955.

Survivors include his wife, Helen; a daughter, Joan Cullinane of Boca Raton, Fla.; a son, James Russell Carreker of Adelaide, Australia; two granddaughters; and a great-grandson. Memorials may be made to the Phi Kappa Tau Foundation Scholarship Fund, 5221 Morning Sun Road, Oxford, OH, 45056.



COOPERATIVE STANDARDS PROGRAM

Approved Projects

New Standard

ASAE S584 MAR2005, Cotton Gins – Method of Utilizing Emission Factors in Determining Emission Parameters. This standard will aid permit and consulting engineers in calculating various air pollution parameters, preparing air pollution permit applications, responding to notice of violations, recommending modifications to existing ambient air pollution control systems, and designing and developing new air pollution abatement systems that comply with SAPRA regulations.

Revised Standards

ANSI/ASAE S522.1 JAN2005 (ISO5674:2004 (E)), Tractors and Machinery for Agricultural and Forestry – Guards for Power Take-off (PTO) Drive Shafts – Strength and Wear Tests and Acceptance Criteria. Approved by the Power and Machinery Division. It is an adoption with deviations of ISO 5674:2004(E).

ASAE S384.2 MAR2005, Manure Production and Characteristics. This revision was a joint effort of members from ASAE and The Federation of Animal Science Societies. The estimates within the standard were revised to allow an estimate of manure characteristics that is relevant to a wide range of dietary options and animal performance levels commonly observed in commercial production. The new standard provides equations for predicting manure characteristics based upon dietary and performance outputs. The standard also updates tabular values for manure characteristics based upon typical situations.

For more information, contact ASAE Standards, 2950 Niles Road, St. Joseph, MI 49085-9659; 269-428-6331 or 269-429-0300 ext. 315, fax 269-429-3852.

MEMBER NEWS

Merlin N. Nelson, an engineer with the Natural Resources Conservation Service (NRCS) in Bozeman, Mont., was presented an appreciation award for his many years of service to Montana agriculture from the Irrigation Equipment Manufacturers and Montana Irrigation Dealers.

Nelson, who plans to retire from the NRCS this year after 38 years of service, has worked as an irrigation and waste management engineer in Montana since 1976. He began his career with the Soil Conservation Service, predecessor to the NRCS, while a student at the University of Minnesota. He worked as an engineer for the agency in Minnesota from his graduation in 1971 until he moved to Montana in 1976. He has been a member of ASAE for eight years.



Lindsay N. Birt was awarded the National Society of Black Engineers Fellows Scholarship at their Annual Convention in Boston, Mass., held in March. The award is given to student members who have demonstrated high scholastic performance, dedicated service to the society and other organizations, and who possess high professional promise.

Birt is a master of science student in the Biological and Agricultural Engineering Department at Texas A&M University. A member of ASAE for two years, she is working on evaluation of compost specifications as an erosion control and stormwater best management practice.



WELCOME NEW MEMBERS

ASAE welcomes the following new members who joined the Society, reinstated a lapsed membership, or upgraded to full membership from student/preprofessional membership in April. A warm welcome to all these members.

New Members for April

Moses Y. Abukari, Wageningen University
 Daniel P. Allen, Allen Engineering Corp.
 Francisco J. Arriaga, USDA-ARS
 Emily M. Ayers, University of Maryland
 Nazneen Azmat
 Nicholas J. Bellovary, Lawrence Technological University
 Mike R. Bohnert, Monsanto
 Victor E. Cabrera, University of Miami
 Tong-un Chang
 Michael V. Chau, GAF
 Gabriel R. Chedister, United States Air Force
 Somnuk Chusilp, Khon Kaen University
 Deisy Y. Corredor, Kansas State University
 Xin Dai, Idaho Department of Environment Quality
 Ahmed A. Eldeiry, Colorado State University
 Theophilus Akinfenna Fashanu, University of Lagos
 John D. Garner
 Ronald Goldszer, Silverman and Goldszer
 Prabhakar R. Gudla, SAIC-Frederick
 Jesse Guerrero, John Deere
 Robert E. Harrison, USDA-ARS
 Jon M. Hathaway, North Carolina State University
 Alan Hepner, Pinetree Engineering Inc.
 Hai Huang, Pioneer Hi-Bred International
 Brent C. Jessop, University of Guelph
 Jennifer L. Johnson, North Carolina State University
 Narayanan Kannan, Texas A&M University Research Center
 Jessica L. Kozarek, Virginia Tech
 Adam B. Lawler, Ronald E. Osman and Associates Ltd.
 Tom Lee
 Juhua Liu, Colorado State University
 Kevin W. McDonald, Lowes
 Yahaya Mijinyawa, University of Ibadan
 Kelly T. Morgan, University of Florida

Joshua T. Morton, Kansas State University
 Gregory D. Mueller, University of Wisconsin
 Daniel Mwaniki Ngandu
 Daniel Ottenheimer, Mill River Consulting
 Ferhan Ozadali, Gerber Products Co.
 Sudheer Kulamulla Parambath, Indian Institute of Technology Madras
 Candice D. Piercy, Virginia Tech
 Shane Powell, Birdsong Peanuts
 Robert J. Randall, Donovan Engineering Limited
 Carl Leslie Reynolds, University of Wyoming
 Mike A. Rowan, Ohio State University
 Alireza Sarbazi, Azad University
 Dean R. Scanlen, Engineering Outcomes Ltd.
 Elizabeth M. Schroeder, Schlumberger Drilling and Measurements
 Balaji Sethuramasamyraja, University of Nebraska-Lincoln
 Brian J. Sevier, University of Florida
 Mohammed Majaz Shaikh
 Michael P. Sherman, NCDENR-DWQ
 Krista L. Sider
 Manjeet Singh, Punjab Agricultural University
 Karuppusamy Sivakumar
 Somposh Sudajan, Khon Kaen University
 Maureen Suryaamadja, Iowa State University
 Philip I. Taucer, Texas A&M University
 Thavachai Thivavarnvongs, Khon Kaen University
 Ravindra C. Thool, SGGI Institute of Engineering and Technology
 Huong TL Tran, Iowa State University
 Fengyu Wang, University of California Davis
 Cumnueng Watyotha, Khon Kaen University
 Seree Wonapichet, Khon Kaen University
 Brandy Jean Woolbright, Irish Drafting and Design
 Marvin W. Wuertz
 Jerome Yerly, Hu Yaoping

EVENTS CALENDAR

ASAE Conferences and International Meetings

To receive more information about ASAE conferences and meetings, contact the Meetings Department at 800-371-2723 or hq@asae.org. For the complete list, see www.asae.org/resource/asaevents.html.

2005

July 17-20 **ASAE Annual International Meeting**. Tampa Convention Center, Tampa, Florida, USA.

2006

April 8-12 **International Symposium on Hydrology and Management of Forested Wetlands**. New Bern, North Carolina, USA.

July 9-12 **ASAE Annual International Meeting**. Portland, Oregon, USA.

2007

June 17-20 **ASAE Annual International Meeting**. Minneapolis, Minnesota, USA.

ASAE Section and Community Events

For more information, contact the person identified in each listing. For the complete list, see www.asae.org/resource/community.html.

2005

June 26-29 **CSAE/SCGR Annual Meeting**. Winnipeg, Manitoba, Canada. Contact Derek Inglis, inglisdh@ms.umanitoba.ca, www.csae-scgr.ca.

Aug. 7-10 **NABEC Section Meeting**. University of Delaware, Virdon Center, Lewes, Delaware, USA. Contact Ken Lomax, 302-831-2468, kml@udel.edu.

Sept. 22-24 **Pacific Northwest Section, 60th Annual Regional Conference**. Lethbridge, Alberta, Canada. Contact Lawrence Papworth, 403-329-1212, lawrence.papworth@gov.ab.ca.

Sept. 29-Oct. 1 **North Central ASAE/CSAE Conference**. Student Union, South Dakota State University, Brookings, South Dakota, USA. Contact K. Muthukumarappan, muthukum@sdstate.edu.

Oct. 12-13 **Texas Section Meeting**. Grapevine Convention Center, Grapevine, Texas, USA. Contact Kenneth Klanika, kklanika@bexp3d.com.

ASAE Endorsed Events

For more information, contact the person identified in each listing. For the complete list, see www.asae.org/resource/endorsevents.html.

2005

Aug. 21-24 **International Conference on Environmental Effects of Agricultural Practices: Remediation, Prevention, and Sustainability**. Hilo, Hawaii, USA. Sponsored by U.S. EPA Office of Science Policy and the Center of Hazardous Substance Research at Kansas State University. Contact Jeffrey Field, 913-551-7548.

Sept. 7-8 **IUV Technology 2005**. Denver, Colorado, USA. Sponsored by Industrial Utility Vehicle and Mobile Equipment Magazine/Webcom Communications. Contact Nick Depperschmidt, 720-528-3770, nickd@infowebcom.com.

Sept. 12-16 **Frutic 05. Information and Technologies for Sustainable Fruit and Vegetable Production**. Montpellier, France. Contact www.frutic05.org.

2006

TBD **5th International Conference of the Asian Federation for Information Technology in Agriculture**. Bangalore, India. Sponsored by the Asian Federation for Information Technology in Agriculture.

Other Events

For more information, contact the person identified in each listing.

2005

July 17-21 **Coastal Zone 05, Balancing on the Edge**. New Orleans, Louisiana, USA. Sponsored by the NOAA Coastal Services Center. Contact Gale Peek, 843-740-1231, gale.peek@noaa.gov.

July 18-21 **StormCon '05, the North American Surface Water Quality Conference and Exposition**. Orlando, Florida, USA. Contact <http://stormcon.com>.

July 30-Aug. 3 **2005 APS Annual Meeting**. Austin, Texas, USA. Sponsored by the American Phytopathological Society. Contact <http://meeting.apsnet.org>.

Sept. 7-9 **American Feed Industry Association Liquid Feed Symposium** Omaha, Nebraska, USA. Contact AFIA, 703-524-0810, www.afia.org.

Sept. 19-21 **American Feed Industry Association Expo 2005**. Kansas City, Missouri, USA. Contact AFIA, 703-524-0810, www.afia.org.

Sept. 25-29 **Dam Safety 2005 National Conference**. New Orleans, Louisiana, USA. Sponsored by Association of State Dam Safety Officials. Contact 859-257-5140, www.damsafety.org

Oct. 17-20 **21st Annual International Conference on Soils, Sediments and Water**. Amherst, Massachusetts, USA. Contact www.UMassSoils.com.

Oct. 26-29 **SCADA and Related Technologies for Irrigation District Modernization**. Portland, Oregon, USA. Sponsored by USCID. Contact www.uscid.org/05scada.html.

Oct. 27-28 **2005 ABET Annual Meeting**. San Diego, California, USA. Contact www.abet.org/AnnualMeeting/2005AnnualMeeting.html.

Nov. 4-5 **Agricultural Engineering 2005, High Tech for Sustainable Agriculture**. Hannover, Germany. Sponsored by VDI-MEG and EurAgEng. Contact www.vdi.de/landtechnik.

Nov. 5-11 **2005 ASME International Mechanical Engineering Congress and Exposition**. Lake Buena Vista, Florida, USA. Sponsored by the American Society of Mechanical Engineers. Contact Kim Punter, 212-591-8258, punterk@asmc.org.

Nov. 15-18 **XII International Rainwater Catchment Systems Conference**. Vigyan Bhawan, Delhi, India. Sponsored by International Rainwater Catchments Systems Association. Contact www.ircsa2005.org.

To have an event listed here, send information to Suzanne Howard, 2950 Niles Road, St. Joseph, MI 49085, USA; fax 269-429-3852, howard@asae.org. Information must reach us at least two months before the event.

Personnel Service

POSITIONS OPEN

The deadline for copy to be received at ASAE is the first day of the month preceding the month of publication (July 1 for the August issue). Each issue mails on the first day of the month.

Advertisements are \$110 per column (3.5-inch wide) inch, which includes placement on *Resource's* Personnel Service Web page at www.asae.org/resource/persads.html. Ads are posted on the Web site within three business days of final approval and remain there until the last day of the issue month (August 31 for the August issue). If the insertion order is for two months, the cost is \$99 per column inch per insertion.

For more details on this service, contact Pam Bakken, ASAE Personnel Service, 2950 Niles Road, St. Joseph, MI 49085-9659 USA; 269-428-6337, fax 269-429-3852, bakken@asae.org, www.asae.org/resource/persads.html.



**Agricultural
Research
Service**

POST-DOCTORIAL RESEARCH ASSOCIATE IN AGRICULTURAL ENGINEERING OR ANIMAL SCIENCE

The USDA, Agricultural Research Service, Pasture Systems and Watershed Management Research Unit at University Park, Pennsylvania, is seeking a qualified individual for a Post-Doctorial Research Associate position.

DESCRIPTION OF DUTIES: The research assignment focuses on the "Management and Economics of Integrated Forage and Animal Production Systems." Responsibilities of this position include the refinement, verification, and application of a whole farm simulation model in the environmental and economic evaluation of grass-based beef and dairy production systems. Projects may include alternative manure handling and application technologies, warm-season grass pasture systems in the Southeast, and grass finished beef production in the Northeast.

QUALIFICATION REQUIREMENTS: A Ph.D. in Agricultural Engineering, Animal Science, or a related biological/physical science is required. In addition, the incumbent must show the ability to initiate and lead research projects; plan, develop, and apply computer models; interpret results; and prepare research articles for refereed publications. Preference is given to candidates whose degree has been received within the last four years. This position requires U.S. citizenship or citizenship in an allied country.

APPLICATION INFORMATION: Application materials should include a resume, list of publications, copy of your college transcripts, and documentation of previous experience with computer modeling and simulation. Additional information on application requirements is available at: <http://www.afm.ars.usda.gov/divisions/hrd/hrdhomepage/vacancy/pd962.html>. Information on the employee benefits for this type of position is available at: <http://www.usajobs.opm.gov/ei61.asp>. The beginning salary for this position is \$50,541 per annum plus benefits.

For further information on the duties and responsibilities of this position or to submit an application, contact

Dr. C. Alan Rotz
Pasture Systems & Watershed Management Research Unit
Curtin Road, Bldg. 3702
University Park, PA 16802-3702
Phone: 814-865-2049
Fax: 814-863-0935
Email: al.rotz@ars.usda.gov

USDA/ARS is an Equal Opportunity Employer

WATER RESOURCES ENGINEER

Water resources planning, hydrologic/hydraulic modeling, stormwater management, water quality assessments, resources planning. Minimum B.S., AutoCAD, HEC-RAS, SWMM, Pond Pack preferred. Full benefits package.

Resume with salary requirements: Susan Slade, Williamsburg Environmental Group, Inc., 3000 Easter Circle, Williamsburg, VA 23188. Phone, 757-220-6869, Fax, 757-564-8157, e-mail, sslade@wegnet.com. Website: www.wegnet.com.

HEAD, DEPARTMENT OF BIOSYSTEMS ENGINEERING AND ENVIRONMENTAL SCIENCE, UNIVERSITY OF TENNESSEE

The Head is responsible to the Deans for leadership, administrative oversight, and coordination of extension, research, and teaching functions of the Department. Administrative responsibilities include: program development/coordination; management of fiscal, personnel, and physical resources; faculty, staff, and student recruitment; liaison with alumni, industry, agencies, and professional organizations; cooperation with other units within the University; leadership in attracting funding; and compliance with Affirmative Action policy. The Department includes 16 biosystems engineering faculty and 9 soil and environmental science faculty. Among other qualifications, the successful candidate must have a Ph.D. in Agricultural Engineering, Soil Science, or a closely related field and show evidence of achievement sufficient for appointment as full Professor. Please see the complete position announcement at the Department's web site at <http://bioengr.ag.utk.edu/>. Screening of applicants will begin July 1, 2005. To apply, send a current curriculum vita, a letter detailing your interest in the position, a statement of leadership philosophy, and contact information for five professional references to Dan McLemore, Search Committee Chair, 2621 Morgan Circle, UT, Knoxville, TN 37996-4518, 865-974-7231, dmclemor@utk.edu. The University welcomes and honors people of all races, genders, creeds, cultures, and sexual orientations, and values intellectual curiosity, pursuit of knowledge, and academic freedom and integrity. UT is an EEO/AA/Title VI/Title IX/Section504/ADA/ADEA institution in the provision of its education and employment programs and services.

Position: Civil Engineer

Salary: GS - 7/9/11 (\$39,738 - \$64,843)

Location: St. Albans, Vermont

The USDA - Natural Resources Conservation Service in Vermont is seeking to employ a full time civil/agricultural engineer to provide technical assistance to private landowners for conservation programs. The majority of work will include the design and construction inspection of manure storage and handling systems on dairy operations. For more information go to:

<http://jobsearch.usajobs.opm.gov/a9nrcshq.asp>

or call Rob Allen, State Conservation Engineer at (802)951-6796 Ext. 231.

Personnel Service

ASSISTANT PROFESSOR AGRICULTURAL AND BIOLOGICAL ENGINEERING MISSISSIPPI STATE UNIVERSITY

The department of Agricultural and Biological Engineering at Mississippi State University is seeking applications for an assistant professor position in the area of bioenergy. The position will be approximately 50% teaching and 50% research with a tenure track, 9-month appointment. The person will be expected to obtain extramural funding to support a comprehensive research program in bioenergy systems which will become nationally recognized. This program could include such applications as biomass gasification, biofuel development, renewable hydrogen production, biochemical conversion, hydrogen fuel, and feedstock handling/conditioning which are all ongoing research areas in the department. Interest and/or expertise in bioenergy is required, and supporting expertise in precision agriculture, bioprocessing, nanotechnology and/or bioenvironmental engineering would be considered complementary and desirable. The individual will be expected to participate in teaching in the Biological Engineering and the Agricultural Engineering Technology and Business curricula, advise graduate and undergraduate students, and to conduct research in the area of bioenergy. The successful candidate should have a demonstrated record of scholarship and evidence of the potential to secure extramural funding. A Ph.D. in Biological Engineering, Agricultural Engineering, or other related discipline is required. Applications will be accepted until July 1, 2005 or until a suitable candidate is found. Send a resume, copies of transcripts, and letters of support from three references to:

Dr. William D. Batchelor, Department Head
Department of Agricultural and Biological Engineering
Mississippi State University
Box 9632
Mississippi State, MS 39762

*Mississippi State University is an Equal Opportunity/
Affirmative Action Employer*

PROJECT ENGINEERS & PROJECT MANAGERS

LBFH, Inc. leverages the skills and experience of all employees and offers an environment that fosters individual growth and rewards performance. You'll be working for an award-winning company with an impressive track record. This is an amazing opportunity to join LBFH, Inc. and gain experience as a Project Engineer, Team Leader or Project Manager.

Qualifications:

- Minimum of 6+ years progressive civil engineering experience in Land Development, Water Resources or Water and Wastewater.
- BS or Master's degree in engineering from an A.B.E.T accredited college or university.
- Professional Engineering License required (preferably registered in Florida).
- 3+ years experience supervising/managing a team of engineers and techs (for Team Lead and Project Manager positions).
- Demonstrated successful performance in dealing with all levels of internal and external business clients.

LBFH, Inc. provides Civil Engineering, Survey/Mapping & GIS services to private and government clients. Our corporate office is located in Palm City, Florida with branch offices in West Palm Beach, Ft. Pierce, Okeechobee, Ft. Myers and Orlando. We offer competitive salaries and an excellent benefits package including health insurance, 401(k), Paid Time Off and flexible schedules. Please submit resumes with salary expectations to careers@lbfh.com or visit our website at www.lbfh.com for more information. Please reference job code: ASAE-05 on your resume submission.

POST-DOCTORAL BIOMASS PROCESSING ENGINEER THE UNIVERSITY OF TENNESSEE

Responsibilities include investigative engineering research and experiment oversight for lignocellulose biomass deconstruction studies involving instrumented cutting, chopping, grinding, and milling devices, and other biomass processing equipment. Qualifications include earned Ph.D. in agricultural, biosystems, mechanical, or related engineering fields; demonstrated knowledge of biomass processing equipment, and ability to document and communicate technical research in English. Full announcement of 30-month position listed as Research Associate II at <http://bioengr.ag.utk.edu/positions/>. To apply send application letter, research goals, transcripts, vitae, and 3 reference letters and contact information to Dr. A.R. Womac, P.E., awomac@utk.edu, UT Biosystems Engineering, 2506 E.J. Chapman Dr., Knoxville, TN 37996-4563. UT is EEO/AA employer.

SALES ENGINEER

Hypro LLC, a leading manufacturer of pumps, has an immediate opening for a Sales Engineer. This position involves 50% tech. sales & 50% engineering tech. service along with project mgmt. of pump and fluid mgmt. systems for our agricultural products in the Spray Group. Responsibilities include direct sales contact & primary point contact, development & growth of accts., create and deliver customer presentations, initiation & mgmt. of designated customer new product development. Must provide engineering & application tech. leadership to customers & internal support functions, contribute to the writing & review of tech. manuals. Position requires a Bachelor's Degree in Engineering (ME) and 2 or more yrs. Related experience, and the ability to travel nationally and internationally. Hypro offers a competitive salary, benefit pkg including 401(k). If you are interested in working in a team environment, please send your resume to: Hypro LLC, Human Resources, 375 - 5th Ave NW, New Brighton, MN 55112, Fax: (651) 766-6619, E-Mail: marlene.johnston@hypropumps.com, Equal Opportunity Employer

POSITIONS WANTED

ASAE members are entitled to a two-month listing free of charge. Nonmembers are charged \$55 for a one-month listing. Includes placement on *Resource's* Personnel Service Web page at www.asae.org/resource/persads.html. For further information about an ad or for more details on this service, contact Pam Bakken, ASAE Personnel Service, 2950 Niles Road, St. Joseph, MI 49085-9659 USA; 269-428-6337, fax 269-429-3852, bakken@asae.org.

AGRICULTURAL ENGINEER, PhD, with 13 years research experience, immediately available for product design or R&D job in the industry or university. Expertise includes machinery design, instrumentation and testing, flour and rice milling, optical spectroscopy applications in grain quality and particle size analysis, image processing, and statistical modeling. Experienced in project management, teaching/training, and technology commercialization. Currently training for Six Sigma Certification. Published 15 technical articles. Proficient in AutoCAD, SAS, Grams-PLS, working knowledge of Solidworks, HP-Vee, C++, some MATLAB. Available immediately. W-1050

Nebraska Tractor Test Law

Within a historical context, the research and influence continue

William E. Splinter

In 1919, the Nebraska Legislature passed a bill requiring that any agricultural tractor sold in the state must have its advertised performance claims verified by a board of three engineers. The reason for this law is interesting.

This was a time of great ferment, with literally hundreds of small companies attempting to enter the rapidly expanding market for internal combustion engine-powered tractors. In the late 1800s, steam-powered “traction machines” gained acceptance, powering plows and providing belt power for grain separators. Beginning in the 1890s, tractors with internal combustion engines were introduced and captured approval. Entrepreneurs presented increasingly flamboyant claims touting performance of the machines.

The question naturally came up: Which of these alternatives would be best suited for an individual farmer? Rational measurements of tractor performance were first conducted by the Canadian Industrial Exposition at Winnipeg. Starting in 1908, comparisons were made between steam-, kerosene-, and gasoline-powered tractors pulling plows and loaded wagons. Belt horsepower was measured using a Prony brake. A drawbar dynamometer was introduced to measure pull. Some 100 performance parameters were measured, such as water consumption and length of furrow plowed. The University of Nebraska’s L. W. Chase and was in charge of the 1913 program and a judge. World War I cancelled the 1914 program.

A number of national plowing demonstrations were held following the Winnipeg Tests, such as the one near Fremont, Neb. in 1916, but these did not provide technically comparative information. Meanwhile, farmers continued to replace their work animals based on what information they could gather about the various tractor models.

One such farmer was Wilmont Crozier, residing near Osceola, Neb. He had purchased a “Ford” tractor manufactured in Minneapolis, Minn. (not by Henry Ford). Its performance was totally unsatisfactory. It so happened that he was also a member of the Nebraska Legislature’s House of Representatives and, with the technical assistance of Chase, authored the Nebraska Tractor Test Law in 1919. He was joined by another farmer, state Sen. Charles Warner, and the bill passed unanimously.

Chase then established a tractor-testing facility at the University of Nebraska and initiated testing in 1920. Based on his experience with the Winnipeg plowing contests, he established two fundamental tests: horsepower and fuel consumption on the belt and on the drawbar. More than

100 tractor companies applied for testing, and 67 tractor tests were completed that first year.

Although the jurisdiction of the law extended only to the borders of the State of Nebraska, the demand for fair and unbiased performance data quickly expanded interest to national and international markets. Several countries in Europe and Japan established their own facilities to certify tractor performance following World War II. Coordinating meetings are still held annually to ensure commonality in reported results.

With today’s level of sophistication, the question of continuing these tests has been raised. First, if anyone thinks tractor manufacturing is a “mature” or static industry, they have only to visit one of the major trade shows, such as Husker Harvest Days in Nebraska, to see the impressive changes being introduced each year. Many innovations over the past years are the result of research at the Nebraska Tractor Test Laboratory or other universities and test stations. Tests at Nebraska determined that rubber tires improved traction efficiency over steel lugs by 25 percent. Noise-level testing was a result of a finding at the University of Nebraska: entering freshmen with farm backgrounds had a typical hearing loss that audiologists called “tractor ear.” As a result, measurements of the noise level of tractors were initiated. Monitoring farm-related deaths indicated that many were a result of tractor overturn. This led to research on the overturn characteristics of tractors and to overturn tests to ensure operator safety. Concerns expressed by farmers that three-point hitches were lifting equipment such as planters too slowly led to tests to verify lift capacity. When rubber tracks were introduced, tests were run to compare performance with conventional tires. Of course, tests of horsepower and fuel efficiency continue, just as first initiated by Chase in 1920, but with modern instrumentation.

Farmers’ on-going reliance on the unbiased testing of tractors is illustrated by the more than 1,000 hits per day that are logged at the test lab’s official Web site, www.tractortestlab.unl.edu. Tractor engineering continues to be a dynamic process, and as long as the industry continues design advances, there will be a demand for an unbiased source of performance comparisons.

ASAE Fellow and Past President William E. Splinter is professor emeritus, University of Nebraska, 307 Morrill Hall, Lincoln, NE 68516 USA; 402-472-8389, fax 402-472-8367, wsplinter1@unl.edu.

Views expressed in this article are those of the author and do not represent the official position of ASAE.

Resource

Magazine's



AE50 2005

Products winning the 2005 *AE50* awards represent the best and the brightest developed around the globe for the agricultural, food, and biological systems industries.

The innovations awarded and highlighted in this issue were selected from numerous entries in the competition sponsored by *Resource*. The judges who chose the winners represent all facets of the agricultural, food, biological, and related systems engineering professions. The expert panel picked the best of products first introduced to the marketplace during 2004. These products are expected to save producers time, costs, and labor while improving user safety.

Problem solving is a major goal in designs, whether one is developing a better way to spread manure, water a golf course, or monitor weather conditions. Environmental concerns must also be factored in while keeping production and operating costs low.

The annual *AE50* program has been applauding engineering achievements for more than a decade. Past winners include companies of all sizes throughout the world.

From better tractors and implements to computer software and high-tech electronic measuring devices and sensors, the 2005 *AE50* winners cover a wide gamut. The *AE50* is the only awards program of its kind to reward

companies for developments in specific areas of agricultural, food, and biological systems.

Many of the new ideas are patented and their names trademarked. Some may become household words in the future. Others will be improved upon as technology advances.

For information on how to enter next year's competition, please contact Sandy Rutter, 269-429-0300 ext. 345 or rutter@asae.org. Information on the *AE50* and *Resource* magazine is also available on the ASAE Web site, www.asae.org.



● Utility tractors host on-board troubleshooting



The John Deere 4000 Twenty Series Tractors feature four turbo charged models with engine power from 43 to 58 hp. A unique computer-controlled instrument panel performs a series of control, diagnostic, and safety functions. Its on-board troubleshooting capability eliminates need for special diagnostic tools. Its feedback display alerts the user to unsafe or improper vehicle condition. Two models (<50 hp) meet EPA Tier 4 regulations; the other two are Tier 2 compliant. The engines have high power density, large torque rise, and low noise. The newly styled one-piece hood improves visibility and engine serviceability. The enhanced e-hydro

controller allows the operator to select a wide range of transmission aggressiveness suited to specific applications. Cruise control allows speed setting to within 0.16 kph (10 mph). The tractors were designed concurrently with a new front loader that can be rapidly attached or dismantled from the seat.

Deere and Company, Moline, Illinois USA; 866-993-3373, www.johndeere.com

AE50 OUTSTANDING



INNOVATIONS 2005

● NR3000 Series operates in narrower aisles and on higher levels

Cat Lift Trucks offers a newly designed line of 24-v electric reach truck models offering breakthroughs in productivity while simplifying machine operation and reducing operating and ownership costs. This 24-v reach truck is frequently used in the distribution and storage of processed and frozen foods, chemicals, and pharmaceutical products. This reach truck family enables users to increase space utilization, operating in much narrower working aisles and storing products at much higher rack levels than traditional material handling devices. Incorporating industry exclusive AC technology and innovative ergonomic features, the new 24-v Cat® reach truck brings unprecedented performance from a 24-v power system, while allowing operators to maintain high levels of alertness, comfort, and overall productivity through reduction of fatigue during operation. This combination of technological and ergonomic features results in higher throughput, lower power usage costs, less potential for product damage, and lower bottom-line costs for end users.

Cat Lift Trucks, Houston, Texas USA; 713-365-1000, www.cat-lift.com

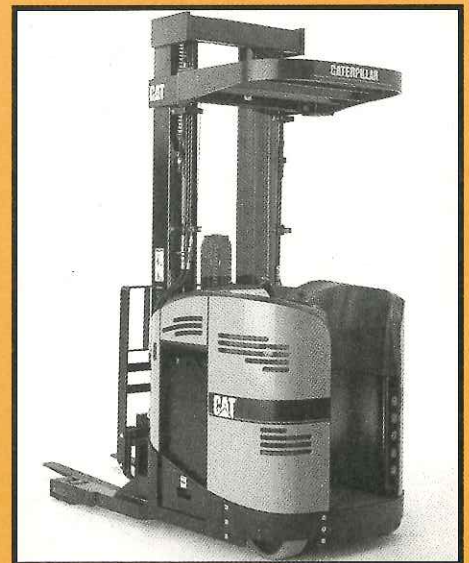

● Nine pump models feature versatility/flexibility



The Hypro Versa-Twin is a breakthrough in fluid pumping technology – a double-acting simplex pump whose body permits adaptation to either a high-pressure plunger pump or a high-flow diaphragm pump by simply changing a few internal components. The innovative design is unparalleled in diversity, and its durable PBT polyester construction is impervious to caustic chemicals giving it a clear advantage over metal in many applications. The strong plastic body allows the pump to generate pressures traditionally reserved for metal construction. In plunger form, the pump will deliver product at 20.7 bar (300 psi); in diaphragm form, it will flow 18.9 L/min (5 gpm). The four-port design allows greater flexibility in system design as

either side of the pump can be plumbed for intake and output, and the lightweight construction makes this pump an ideal choice for mobile applications. Nine different models are available with gasoline engine and electric motor drive options.

HYPRO, New Brighton, Minnesota USA; 800-42HYPRO (800-424-9776), www.hypropumps.com

AE50 OUTSTANDING



INNOVATIONS 2005

● Knife-to-knife action cuts power and header loss

The LEXION C516 corn head harvests 16 rows of field corn, on 0.7-m (30-in.) row spacing, for an exclusive factory-offered 12 m (40-ft) working width. A unique row unit design, driven via shaft drive gearboxes through flexible dual chain coupled drive shafts, provides efficient “knife-to-knife” cutting action for reduced power requirements and header loss, and it leaves behind finely chopped residue for thorough soil-to-stalk contact for increased decomposition. Hydraulically actuated stripper plates simplify setting the head from the cab. Added features include the LEXION exclusive stalk-sensing corn head autopilot system for reduced operator fatigue and greater machine productivity. Nylon front idler sprockets provide quiet operation and increased gathering chain life.



CLAAS Omaha LLC, Omaha, Nebraska USA; 402-861-1000, www.lexioncombines.com

● Balers provide density and size options



The Vermeer 600M Series Balers are high capacity round balers designed to fit the high-end users' needs. These balers are capable of producing good-looking bales in a full range of density settings — from the lightweight, for the consumer with a small, low horsepower tractor, to extremely dense bales for the consumer who can handle the heavy weight packages. The 605M produces 1.5 m- (5 ft-) wide bales and the 604M produces 1.2 m- (4 ft-) wide bales. Both make bales with diameters ranging from 1-2 m (36 – 72 in.). The M series features standard DCF wide pickup, new hybrid starting chamber, heavy duty long lasting components, completely redesigned and simplified net wrap, simple hydraulically powered ramp, and a hay buildup reduction system. These features make it possible to get the job done faster and bale in conditions where it was not possible before.

Vermeer Manufacturing Company, Pella, Iowa USA; 800-370-3659, www.vermeerag.com

AE50 OUTSTANDING



INNOVATIONS 2005

● Shhh!-quiet and all-day ready: golf course vehicle

The Toro Workman e-2050 blends high performance with improved "driveability" and reduced maintenance — all with a noise level just above a whisper. The e-2050 has simple and reliable old-technology electric motor and batteries and high tech electronic controls to give the operator a "no surprises" driving experience. This product is geared for the maintenance professional of a golf course, where reduced noise output is highly valued. Productivity is increased over a gas or diesel machine as the vehicle — when approaching a golfer — does not have to stop and wait for play through. Range is an issue with purely electric-powered vehicles, but the 48-v, flooded cell, lead acid batteries provide more than enough power to get through a full day. After an overnight recharge, the vehicle is ready again. Many features have been incorporated to extend the range and life of the vehicle with onboard tools included to reduce downtime.

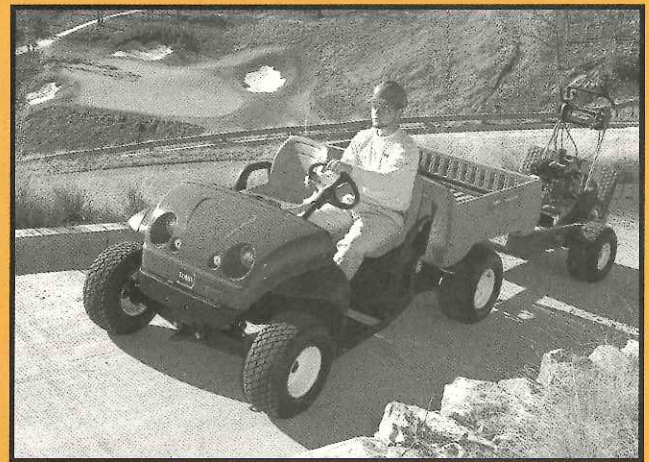

The Toro Co., Bloomington, MN USA; 952-887-8420, www.toro.com

● Yield sensor gives greater resolution

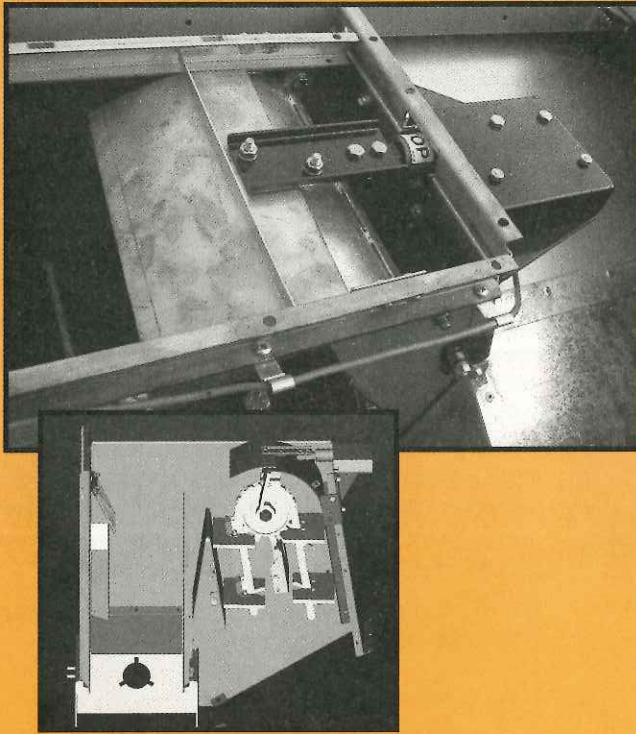

AGCO introduced the GTA Yield Sensor to North America on Gleaner, Massey Ferguson, and Challenger combines at the beginning of 2004. This new, innovative yield sensor incorporates a horizontally mounted load bar with a full-width stainless steel grain target to achieve over four times the resolution compared to previous sensors. The low profile, temperature-compensated design has a "linear response characteristic" allowing for simple, single-point calibration. This single-point calibration provides accuracy across a wide range of harvest rates and crop conditions. The unique operating position of the sensor reduces slope-induced errors by 88 percent or more, improving accuracy in rolling terrain. Designed to be cost-competitive with older yield sensors, the sensor offers customers reliable, highly accurate yield-monitoring capabilities with performance and value.

AGCO Corporation, Duluth, Georgia USA; 770-813-9200, www.fieldstar.com

AE50 OUTSTANDING



INNOVATIONS 2005

● Rotator heightens fields conditions for irrigation application

The PC-R3000 Rotator® is a part-circle sprinkler designed to improve the water application and field conditions under mechanized irrigation systems by directing the watering pattern away from the system hardware. By lessening excess water in the wheel tracks, tire slippage and deep wheel tracks are minimized reducing extra wear on tractors and implements crossing over the tracks during cultivation and harvest. The PC-R3000 operates from 15-30 psi and provides high application efficiency with slow rotating streams that decrease wind drift and evaporation. The PC-R3000 is part of the Rotator® sprinkler line, offering the widest water pattern of any sprinkler on drop tubes for center pivots and linears. This throw performance allows water application rates to more closely match soil infiltration rates and reduce runoff potential of water and agricultural chemicals. In addition, the PC-R3000 can be mounted on the end of pivot systems to add extra acreage or fill in underneath an end gun package moving in and out of the corners.

Nelson Irrigation Corporation, Walla Walla, Washington USA; 509-525-7660, www.nelsonirrigation.com



● Row unit enables spindle harvesting 38 cm (15 in.) crop

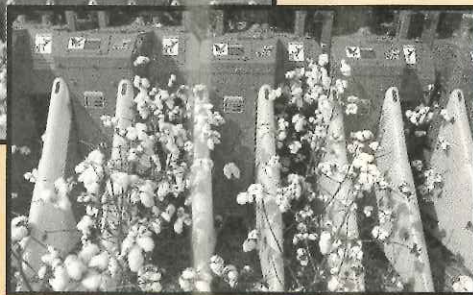
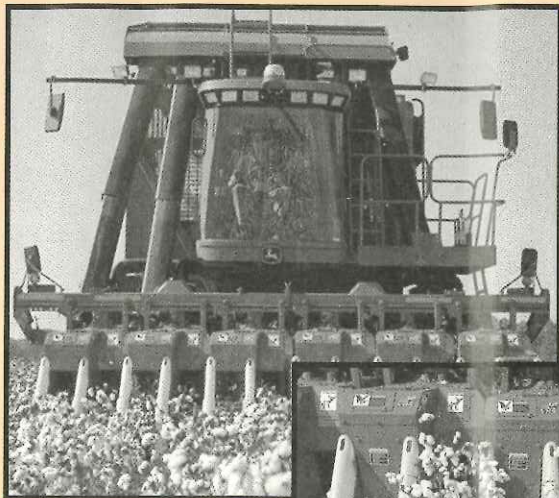

The PRO-12 VRS row unit utilizes a rotary knife along with front and rear feeder assemblies to cut and then transfer cotton stalks into the adjacent row. This allows harvest of cotton planted in 38 cm (15 in.) rows as well as cotton planted in conventional row spacings such as 76, 91, 97, 102 cm (30, 36, 38, and 40 in.). The PRO-12 VRS allows 38 cm (15 in.) cotton growers to spindle pick cotton, an option that increases quality, turnout, and the ability to harvest in more diverse conditions. The current harvest technology for 38 cm. (15 in.) cotton employs use of a broadcast finger header attached to a cotton stripper, which dictates

that the cotton plant must be managed to a much shorter and smaller stalk size than is required for spindle harvesting. The PRO-12 VRS unit redefines the harvest of 38 cm (15 in.) cotton by allowing the customer to reap the agronomic benefits of narrow row and spindle-picked cotton.

John Deere Des Moines Works, Ankeny, Iowa USA; 515-289-3374, www.johndeere.com

AE50 OUTSTANDING



INNOVATIONS 2005

● Weather analysis tool re-tooled

Analysis of "in-field" weather conditions is important for making intelligent and cost-effective decisions relative to plant disease, pests, fertigation, and irrigation scheduling. Weather has a profound impact on crop quality and yield, and field operations are dependent on weather and soil conditions. Further, climatic conditions can vary significantly in spatial distribution, particularly with regard to temperature, rainfall, and frost. Spec7 Pro software is a powerful data (weather) analysis tool used in conjunction with WatchDog weather stations and data loggers. New features/functions to the software include: an interactive dynamic graphing function for sensor trend analysis; customized reports that virtually eliminate exporting data for analysis; auto-downloading of data at user defined intervals; a frost alarm that will call your phone or pager; the ability to generate log files for data-to-Web applications importing data from other stations or Web sites for analysis; and a new data file structure for ease of sharing data with other users.

Spectrum® Technologies, Inc., Plainfield, Illinois USA; 800-248-8873, www.specmeters.com



● Plant Transfer and Transplanting System moves with efficiency



The Matrix Plant Transfer and Transplanting System transplants a plurality of plants/seedlings/plugs in a matrix formation from a supply tray into receiving trays/flats/pots/containers. Equipment costs may be reduced by as much as 95 percent when compared to commercially available, traditional computer-controlled, automated transplanting equipment. This transplanter eliminates the row-by-row upward plant dislodging, grabbing, and planting distance adjusting from the traditional transplanting operation, and accomplishes the whole tray/flat matrix dibbling and transplanting operations with a simple manual operation. The self-contained system controls all operations: up-and-down motion of upper and lower indexing/conveying tables, accurate indexing of supply tray and receiving flats, dibbling of growth media, and pushing plants/seedlings/plugs into receiving flats to achieve the precision plant transfer and transplanting. The system provides several matrix patterns from a supply tray to transplant a set of multiple plants/seedlings/plugs simultaneously at a time, shift the supply tray to a subsequent position, and transplant next set of multiple plants/seedling/plugs.

International Innovative Technology, Inc. (IIT), Raleigh, North Carolina USA; 919-773-0632, www.airpruning.org

AE50 OUTSTANDING



INNOVATIONS 2005

● Baby Root Hog harvests with scoop-and-shake

The Baby Root Hog Harvester joins the family of Root Hog Harvesters supporting harvest of bare root shrubbery in the ornamental nursery stock industry. This new system utilizes a simple scoop-and-shake concept to complement the harvesting of bare root shrubbery grown on beds inside greenhouses. Expensive real estate inside greenhouses encourages growing plants tight to the end walls, often resulting in a difficult environment for a large "down the row" harvester to maneuver. The Baby Root Hog opens up the ends and cleans the edges allowing a "down the row" harvester to operate more efficiently. The Baby Root Hog is a low-tech design performing a high-tech function. The machine's simple and effective design will benefit the smaller producers as well as larger operations.



Faulring Mechanical Devices, Inc., North Collins, New York USA; 716-337-3682, www.faulring.com

● Cutter-bar system improves flexibility, durability



The LEXION F540 flex head, with *MaxFlex™* technology, features an all-new cutter-bar system attached to a floating, segmented stainless steel floor, which improves flexibility and durability. *MaxFlex™* features extremely variable cutting height via in-cab-controlled variable flex-range. Performance is achieved from a 17.5-cm (7-in.) vertical flex and full-depth – fore to aft – poly coated, spring steel skid plates tied into the combine's auto-contour system. Variable cutting height is controlled hydraulically, for ease of change over to rigid operation. Attached auto-contour sensing rods provide additional ground contour ability when operating off the ground in standing crops.

CLAAS Omaha LLC, Omaha, Nebraska USA;
402-861-1000, www.lexioncombines.com

AE50 OUTSTANDING



INNOVATIONS 2005

● Yield-mapping system provides Quick, Standard Weight, and Post Calibration

The Harvest Doc Cotton™ yield-mapping system provides cotton customers with the ability to monitor instantaneous yield rates, accumulated yields, and acreage counting while operating in a cotton picker. This information is downloaded to a PCMCIA datacard and used with JDOffice to create yield maps for post management. A patented microwave sensor provides a state-of-the-art method of mass flow without having to create holes in the cotton conveying air ducts. The sensors actually see through the ducts to measure the flow of cotton. Because there are no holes to drill, the system can be installed on a new or existing cotton picker in approximately four hours. The system uses John Deere global positioning technology to provide site-specific recording of yield through the use of a GPS receiver, a GreenStar display, and a mobile processor. The system allows three methods for calibration: Quick Cal (field calibration), Standard Weight Cal (using a known weight to calibrate), and Post Calibration (using known total end of harvest season weight).

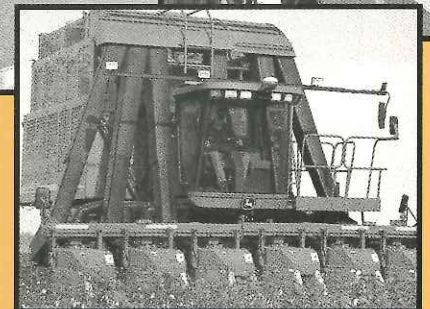
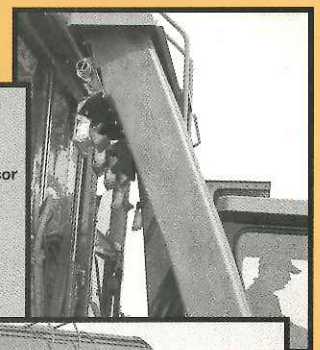
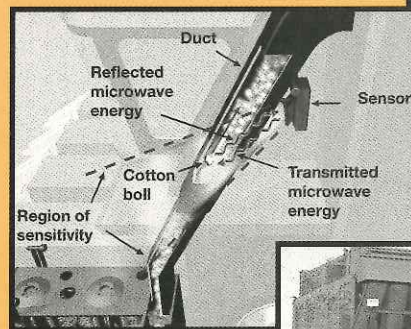

John Deere Ag Management Solutions, Des Moines, Iowa USA; 888-GRN-STAR (888-476-7827),
www.johndeereag.com

● Utility vehicle highlights new VHT components



The RTV900 utility vehicle with tractor technology features the first Variable Hydro Transmission (VHT) with auxiliary hydraulics, power steering, and wet disc brakes. The VHT functions like a tractor's hydrostatic transmission (HST) with exceptions to a servo regulated hydrostatic pump, one fixed displacement motor, and one variable displacement motor, which increases the output torque to the wheels when a heavy load is sensed. To maintain optimum performance, the hydrostatic pump supplies oil to the fixed displacement motor at a constant rate to turn the output shaft on the wheels. When the wheel load increases and the pump pressure exceeds a preset pressure, the pump begins to feed the variable displacement motor to increase the output torque and lower the travel speed to overcome the load.

With its sealed VHT components, the RTV900 will provide farmers, vineyards, nurseries, orchards, and golf courses increased power, lowered maintenance costs, and easy, safe operation.

Kubota Tractor Corporation, Torrance, California USA; 310-379-3370, www.kubota.com

AE50 OUTSTANDING



INNOVATIONS 2005

● Safety a factor in redesigned line

Cat Lift Trucks has launched a redesigned family of large-capacity, cushion-tired, counterbalanced electric lift trucks. They feature enhanced operator-presence detection, lengthened service intervals, increased performance, improved capacity retention, and longer battery shift life. The operator presence detection system disables all truck functions when the operator leaves the normal operating position, and it includes warning indicators for seat belt and parking brake. Some competitive and past offerings of this class of lift truck allowed mast activation, even if the operator was out of the seat, resulting in potentially hazardous work conditions. Service intervals on the model have been increased to 500 hours, allowing the owner to realize higher levels of productivity. In addition, innovations in load-sense hydraulics and transistorized controllers increase battery shift life over previous generation units. The truck comes standard with an advanced display indicating battery charge, fault codes, and motor brush life. Applications include automotive, glass, paper, carpet, steel, bottling, and rubber.



Cat Lift Trucks, Houston, Texas USA; 713-365-1000, www.cat-lift.com

● Opener bearing gives long life to row unit



The new XP Series row unit from John Deere was developed to achieve increased precision, durability, and reliability. New two-piece ductile iron shank assembly and double-row opener bearings provide superior performance. These allow row units to maintain pace with seeding requirements as growers transition to more no-till practices and higher seasonal machine usage. A new double-row opener bearing was developed for this specific condition to provide longer life – up to three times over the traditional single-row bearing in hard, no-till planting conditions. Combining the design flexibility of ductile iron and investment casting processes, a new positive locking seed-tube guard replaces the traditional roll-pin attachment to improve durability and serviceability.

John Deere Seeding Group, Moline, Illinois USA;
866-993-3373, www.deere.com

AE50 OUTSTANDING



INNOVATIONS 2005

● Planter boosts productivity, increases time

The Case IH ASM 24/20 Planter is a new generation planter featuring high capacity/productivity with excellent maneuverability, serviceability, and convenience. Two 40-bushel central fill hoppers and four-section control of seed and fertilizer brings more time for planting and customizing both seed populations and fertilizer application rates to achieve optimal yields. Large floatation tires are mounted on a double-telescoping retractable frame to minimize ground compaction and provide an unmatched single-pass headland turning radius. Despite large field widths and close-coupled planting dimension, in-cab push button controls can fold the planter into a transport envelope of 3 m (10 ft) high and 3.8 m (12.5 ft) wide in less than a minute. Furthermore, the planter toolbar can be raised over 1.5 m (5 ft) for complete access of row units and other tillage attachments.

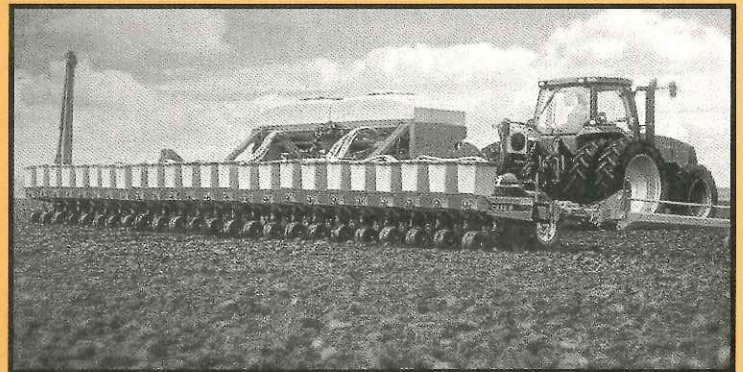

CNH America LLC, Racine, Wisconsin USA; 262-636-0000, www.cnh.com

● New high-uniformity sprinkler added to line



The new MP1000 matched precipitation sprinkler is a small multi-stream sprinkler designed to operate within the micro-spray flow range. The sprinkler is the latest addition to the MP Rotator® product line. A water conservation tool, the MP1000 gives a higher uniformity than conventional sprays in its size range. This sprinkler simplifies design and management by matching the precipitation rate of the other sprinklers on the system. The matched precipitation rate is automatically maintained throughout the arc adjustment. This is a product for new designs or for retrofit on existing systems. The design of the sprinkler provides an adjustable arc and adjustable radius of water distribution. The multi-stream technology makes possible high uniformity and low application rates in areas that previously were hard to irrigate. The sprinkler has application for use in landscape, orchards, vineyards, and small plot crop production.

Walla Walla Sprinkler Company,
subsidiary of Nelson Irrigation
Corporation, Walla Walla, Washington
USA; 509-525-7660, www.mprotator.com

AE50 OUTSTANDING



INNOVATIONS 2005

● Windrowers allow faster field speeds

The new-generation New Holland Speedrower™ self-propelled windrowers are used to harvest hay crops, small grains, and specialty crops when equipped with sickle, disc, or draper headers. These new machines combine higher horsepower Tier II engines, convenient operator controls, and industry exclusive cab and rear-axle suspension systems, providing customers with unparalleled productivity, comfort, and convenience. Increased horsepower allows an operator to maintain higher field speeds and/or use of larger headers for more crop cut in less time. The new 225-hp model can be equipped with the industry's first 5.5-m (18-ft) disc header.



Industry-first, in-cab adjustable, independent header-flotation control allows the operator to adjust header ground pressure to the absolute minimum for any field conditions. The operator need not compromise flotation settings due to unbalanced headers. Industry-first, cab suspension (standard on the three deluxe models) and independent, rear-axle suspension (standard on the largest deluxe model and optionally available on the other two deluxe models) smoothes out the ride for man and machine alike to allow faster field speeds. The results: higher productivity with less wear and tear on both the operator and the windrower.

CNH America, LLC/New Holland, New Holland, Pennsylvania USA; 888-290-7377, www.newholland.com/na

● Sprayer allows application on wide variety of row/field crops



The GK 4W6-T sprayer offers many advantages over conventional four-wheel drive sprayers. With 30.5-cm (12-in.-) wide tracks, 2,271 L (600-gal tank), and 23-m (75-ft) booms, the 4W6-T operates at approximately 41.4 kPa (6 psi) ground pressure and can spray with minimal soil compaction. On the go, track-width adjustment of 1.8-2.5 m (72-100 in.) allows chemical application on a wide variety of row and field crops. The oscillating chassis and independent hydra-pneumatic suspension with auto load leveling, gives the 4W6-T an exceptional ride and excellent boom stability at speeds up to 26 kph (16 mph). The articulating steering system is engineered so the rear tracks follow the front when turning on tight headlands, minimizing crop damage. The combination of state-of-the-art can-bus chemical injection control and the track drive system allows timely and accurate chemical application when conditions are too wet for conventional sprayers.

GK Machine, Inc., Donald, Oregon USA; 503-678-5525, www.gkmachine.com

AE50 OUTSTANDING



INNOVATIONS 2005

● Nozzle dials up easy adjustments

CP® Products Company's Sprayer Turbo Nozzle, the CP-65T-S, is a compact six-orifice, turbo chamber nozzle in a universal quick-change body. User-selected flow rates – 1.1 to 3.8 L/min (0.3 to 1.0 gpm) at 275 kPa (40 psi) – and droplet sizes – 400 to 1000+ microns volume median diameter at 206.8 to 413.7 kPa (30 to 60 psi) – provide flexibility in spray drift control. By turning two dials – one for orifices and one for deflector tips, applicators can quickly adjust spray volume and droplet spectrum on any standard boom sprayer with a single economical nozzle. Ease of prescriptively applying large droplets extends conditions under which safe spray applications can be made. The new nozzle uses an industry-standard, bayonet fitting and can easily be adapted to new and existing sprayers without tools, wiring, or electronics. The nozzle was designed for post-emerge application rigs but can be used on any spray boom with 0.5- to 0.7-m (20- to 30-in.) nozzle spacing.

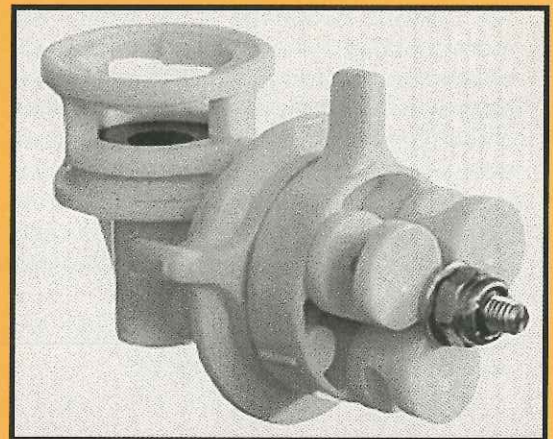

The CP® Products Company, Inc., Tempe, Arizona USA; 866-303-0600, www.cproductsinc.com

● Scraper's new design moves earth and unloads savings

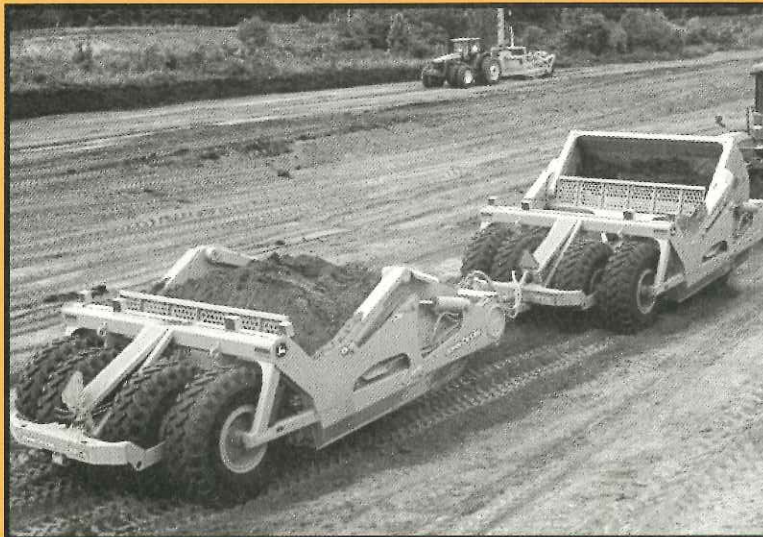

The John Deere Fixed-Blade Ejector Scrapers offer customers the ability to move material more efficiently and reliably, thanks to an all-new design. Featuring a throat opening of 1400 mm (55 in.), the Fixed-Blade Ejector Scrapers can load and unload material easily and provides pick-up of more diverse material. New blade and ejector wall angles allow for easier unloading once the scraper is full. John Deere ejector scrapers realize savings when compared to traditional precision grading and earth-moving equipment. On average, moving material with a John Deere scraper can be done with one third the investment, half the labor, and savings of 30 to 50 cents per cubic yard of material

moved. Available in three different models – 1512E, 1810E, and 1814E, customers may choose the implement that best suits their application and tractor size.

Cameco, a John Deere Company, Thibodaux, Louisiana USA; 985-447-7285, www.johndeere.com

AE50 OUTSTANDING



INNOVATIONS 2005

● Clutch offers new level of overload protection

The Compact Automatic Clutch offers a level of implement overload protection not possible with other types of clutches. The compact, efficient design disconnects the power source from the drive train when overload occurs. During disengagement, the patented design does not allow or generate damaging torque spikes or heat. The clutch uses a unique wedge and spring design to allow a very small diameter while accommodating a relatively large through bore. Various torque settings are available.

Weasler Engineering, Inc., West Bend, Wisconsin USA; 262-338-2161, www.weasler.com

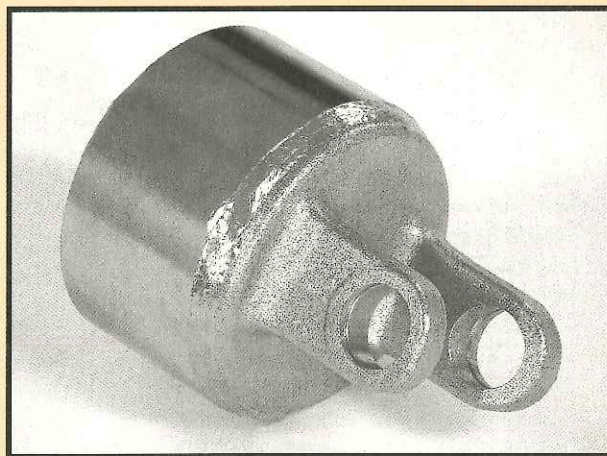

● Paddle tine conditioner shapes up windrows, eases transport and conditioning

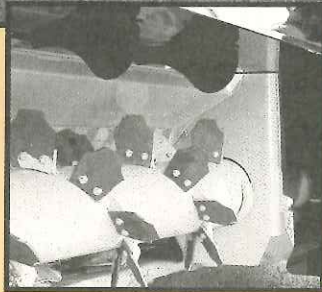
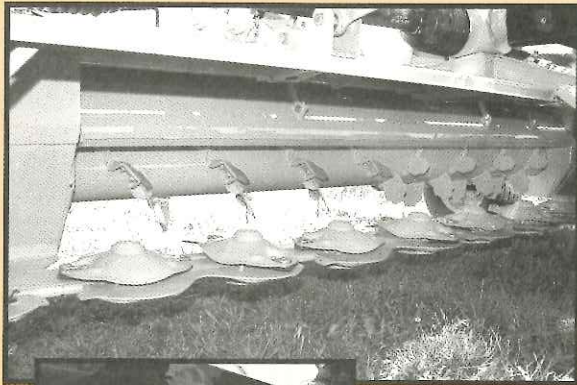

The Vermeer Paddle Tine Conditioner is an attachment for a disc mower conditioner designed to improve windrow formation and versatility in legumes and grass crop. The unique austemper, heat-treated paddles offer a fixed 5 cm- (2 in.-) wide top surface per paddle that allows gentler conveyance and consistent conditioning of the forage by rubbing this area against the adjustable top concave conditioning plate. For more aggressive grass conditioning, there are conditioning bars attached to the concave, which are reversible to penetrate deeper in between each set of paddles. The single-speed spiral rotor allows crop to be moved toward the center of the machine, which is then directed outward through a series of fins mounted to the swathboard. This arrangement allows for greater windrow uniformity and therefore promotes consistent dry down.

Vermeer Manufacturing Company, Pella, Iowa USA; 800-370-3659, www.vermeerag.com

AE50 OUTSTANDING



INNOVATIONS 2005

● Mower incorporates high end, high-tech tractor features

The Kubota ZG incorporates high-end tractor technologies enabling users to swiftly manage mowing operations with ease and comfort. Kubota's wear-resistant, wet-type disc PTO clutch ensures outstanding durability while smoothly transmitting power; durable wet-type disc brakes provide secure engagement. Combining the final drive and twin hydrostatic transmissions, the one-piece integral drive system is enclosed, eliminating potential leakage problems with a maintenance-free transmission. A heavy-duty 2-cylinder gasoline engine, fitted with an external air intake system, is similar to those used for industrial applications. Both transmission and mower deck power is provided via shaft drive eliminating belt and pulley maintenance. Other key features include: foot-controlled hydraulic deck lift and foldable ROPS, deluxe seat, adjustable control levers, and the Kubota Maintenance Lift System, allowing on-site maintenance.



Kubota Tractor Corporation, Torrance, California USA; 310-370-3370, www.kubota.com

● Cotton picker picks up power and speed

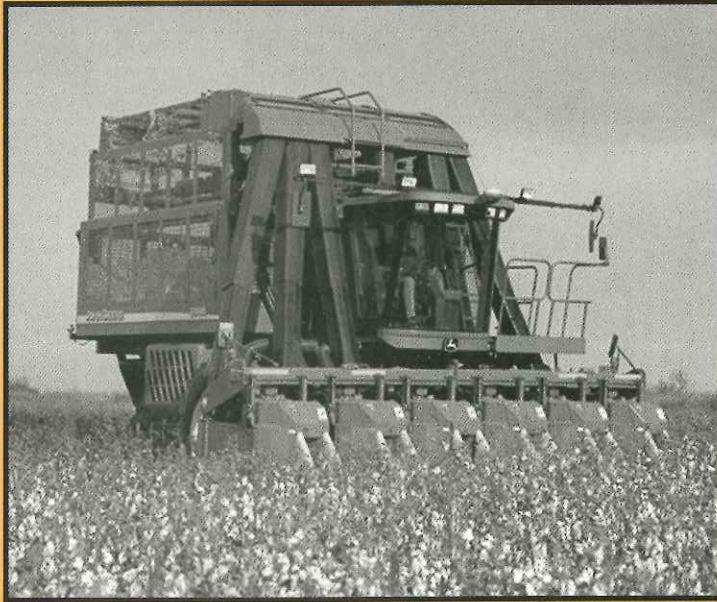

The 9996 Cotton Picker continues the tradition of offering customers productivity enhancements: higher engine horsepower, faster picking speed, and larger fluid tanks that combine to offer superior harvesting capabilities. The machine is equipped with a 350 hp, 8.1 liter (494 cu in.) John Deere PowerTech® Tier II engine, along with a large 757 L (200-gal) fuel tank and 1306 L (345-gal) spindle cleaning solution tank for strong performance during the longest harvest days. A new 2nd gear transmission ratio allows a harvesting speed of up to 7.9 kph (4.9 mph) for improved productivity. The newly redesigned pressure plate in the picking unit increases crop exposure to the picking spindles for improved overall picking efficiency.

John Deere Des Moines Works,
Ankeny, Iowa USA; 515-289-3374,
www.johndeere.com

AE50 OUTSTANDING



INNOVATIONS 2005

● Combine excels in separation performance

Multi-finger separation is a standard feature of the LEXION 560 straw walker combine, which provides enhanced separation performance in all crops and conditions. A unique rotary drum, configured with multiple retractable fingers, is positioned above the straw walker separation system. Greater separation efficiency is achieved from a gentle combing action created by the fingers as they sort through the crop mat, alleviating the tendency for grain to remain lodged within the crop mat.

CLAAS Omaha LLC, Omaha, Nebraska USA;
402-861-1000, www.lexioncombines.com

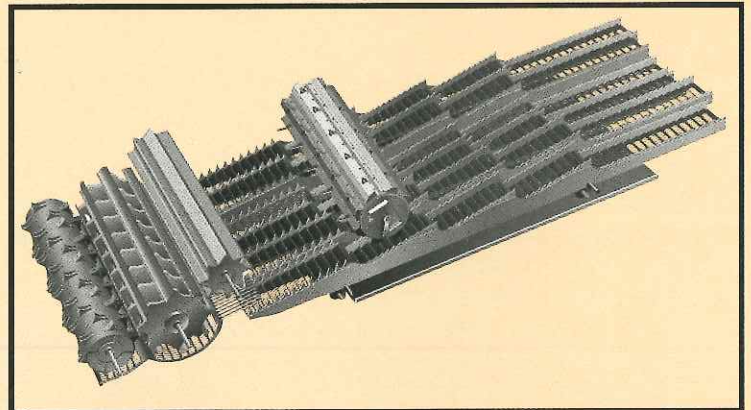

● Guidance system advances

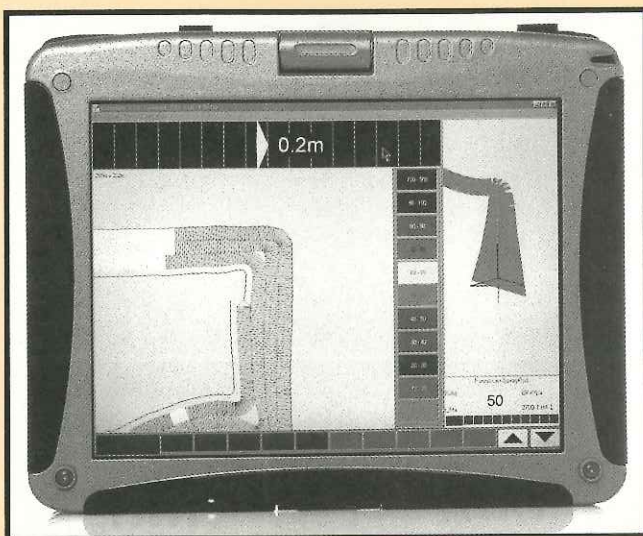

The Farmscan 5400 Professional is a complete guidance, autosteer, autorate, and Variable Rate Technology (VRT) and autoboom control system. The 5400 Professional automatically controls up to 15 boom sections on/off if any overlap takes place, and it switches the boom off at the end of each run when tram-lining. This ensures no double spraying. It displays spray rate, sections on, ground covered, virtual road and lightbar (simultaneously), and controls rate to a prescription VRT map. It also guides or steers (any pattern) up to 50 kph (35 mph); switches boom sections automatically (up to 15 sections); and records work performed. The system features a handy swivel-mounting cradle and a remote button box for optimum user convenience.

Computronics Corporation Ltd.,
Bentley, Western Australia; +6-189-470-1177,
www.farmscan.net

AE50 OUTSTANDING



INNOVATIONS 2005

● Rake: From transport to operation by simple command

The Vermeer R2800 Twin-rake rakes up to 8.5 m (28 ft) of forage material into a windrow that can be processed by a forage chopper, round baler, or square baler. The R2800 moves the rake from transport to operation, completely from the tractor seat, with the Command II monitor. The monitor can be switched between 1) transport to raking width 5.8 - 8.5 m (19 - 28 ft raking width); 2) basket lift [lift height up to 35.6 cm (14 in.)]; 3) and windrow width adjustment 0.8 - 2.1 m (2.5 - 7 ft). The rake basket life is extended as much as 50 percent by the unique floating front basket spindle that reduces stresses in the basket assembly as the basket rotates. The innovative windrow width- adjustment system yields 0.8 - 2.1 m (2.5 - 7 ft) windrows, critical to maximizing capacity of different types of harvesting equipment, with minimal hydraulic pressure. Narrow transport width of 2.6 m (8.5 ft) allows for safe transport between fields and easy entry through all gates. The hydraulically powered baskets with rubber mounted tines sweep only through the stubble keeping the forage free of contamination for maximum quality.



Vermeer Manufacturing Company, Pella, Iowa USA; 800-370-3659, www.vermeerag.com

● Header boasts improved drying rates, flexibility

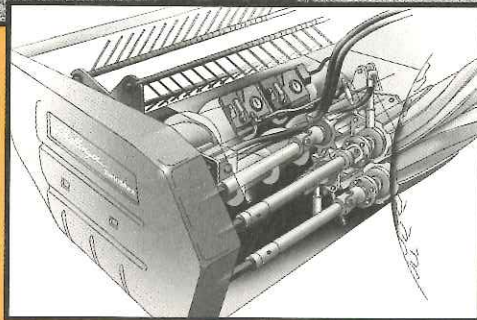

The Hesston 9040 Advanced Conditioner/Challenger AHB TwinMax header cuts, conditions, and either swaths or windrows hay and forage crops. The header offers improved drying rates and easy hydraulic tensioning adjustment of conditioner roll pressure. The header also has larger material transport augers, simplified hydraulic header drives, improved windrow and swath forming shields, and two steel intermeshing conditioner rolls, in front of two intermeshing rubber conditioner rolls. Separate hydraulic valves and control switches allow independent adjustment of conditioning pressure on each pair of conditioner rolls. The front steel rolls condition crop material, feed the material uniformly, and protect the rear rubber rolls from rock and foreign material damage. The rear rubber rolls further condition the crop material and feed the material into the operator selectable swath board or forming shields. This combination brings operator-selectable conditioning of crop material and improvement in drying rates. The design, as well, brings more flexibility to a wider range of crops.

AGCO Corporation, Duluth, Georgia USA; 770-813-9200, www.agcocorp.com

AE50 OUTSTANDING



INNOVATIONS 2005

● Sprinkler offers distribution uniformity advantages

The Rain Bird® LF1200™ Series Sprinkler is built to withstand harsh conditions in agricultural applications. It combines the advantages of an impact sprinkler with stream-height flexibility to deliver precise, uniform, and unrivaled water distribution. The weighted drive disk provides an increased dwell time between stream interruptions achieving maximum throw distance. The water path has break-up features maximizing throw distance and optimizing uniformity. It's ceramic radial bearing lasts longer than conventional counterparts. A flow-dependent brake stabilizes rotation time over a range of temperatures and water pressures. Composite-engineered thermoplastic deflectors resist dirty-water wear, and an engineered thermoplastic drive disk protects the brake mechanism from wind-blown debris and freezing. EZ-twist tabs allow simple removal of drive unit from body. Color coded nozzles and deflectors allow for easy identification and snap into place with the push of a finger.

Rain Bird Corporation, Agri-Products Division, Glendora, California USA; 800-435-5624, www.rainbird.com

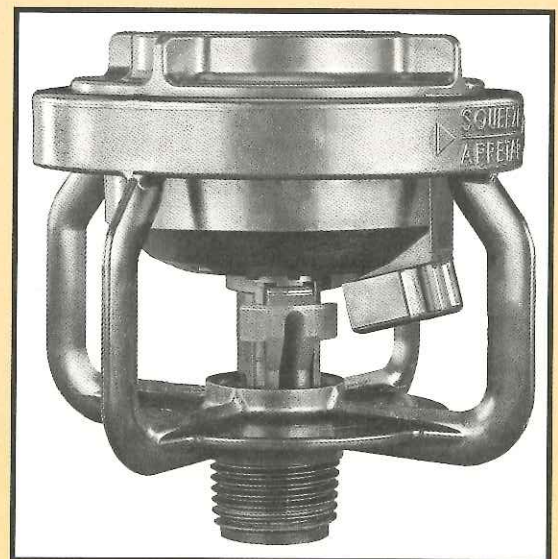

● Hyperspectral imaging sensor offers new imaging capabilities

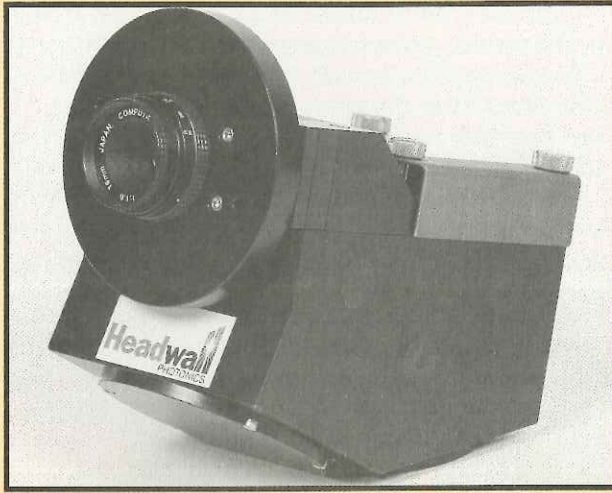

The HyperSpec™ VS product generates hyperspectral images comprised of precise spectral and spatial information to: 1) allow agricultural engineers to assess crop health and chemical composition utilizing an airborne platform and 2) allow food processing scientists to manage quality and product attributes across high volume manufacturing process operations. Headwall Photonics' HyperSpec™ VS imaging spectrographs have ushered in a new era of imaging capabilities to support precision agriculture and farming techniques while also enabling break-through applications for the food processing industry. The HyperSpec™ VS products generate high resolution imaging data in either the Visible range (400-1000 nm) or the SWIR range (900-1700 nm) representing the spectral regions where precise spatial and spectral information is most critical for agricultural and food processing applica-

tions. The unprecedented imaging performance allows users to access the critical spectral information necessary to provide greater control over limited resources and to make better decisions relative to a wider range of operating environments and application conditions.

Headwall Photonics, Inc., Fitchburg, Massachusetts USA; 978-353-4010, www.HeadwallPhotonics.com

AE50 OUTSTANDING



INNOVATIONS 2005

● ASL front-end loader has the right angles

This newly design loader is categorized as a true "accurate self-leveling" (ASL) front-end loader. The main innovation: the bucket remains at a set angle throughout the entire movement range of the front-end loader lift arms, from fully-lowered to fully-raised. The bucket can be set at any level position, from full "rollback" position to full "dump" position, and will remain at the same angle to the ground throughout the loader-lift operation. The bucket and bucket-tilt cylinders are both attached to a special bucket cylinder bracket that also remains at a constant angle to the ground throughout the lift arms' entire range of movements. The bucket also has an extremely large range of angle movement, from 100°-dump to 40°-rollback angle.



Leon's Mfg. Company Inc., Yorkton, Saskatchewan Canada; 306-786-2600, www.leonsmfg.com

● Greensmower eliminates leak points

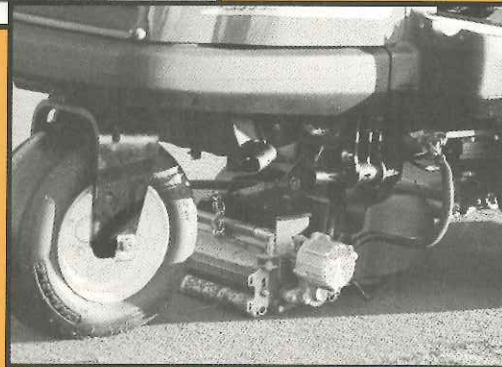

The 2500E triplex Greensmower provides an electric reel drive system that reduces hydraulic leaks and provides the power necessary to perform all functions of a hydraulically driven reel drive. The electric drive system eliminates 102 potential hydraulic leak points. The power – to vertical-mow, scalp, and cut multiple days of turf growth – is provided by three 48V/45-amp brushless motors. The motors are controlled individually with electronic controllers that have self-diagnostic features. The diagnostics can detect 12 fault codes in the reel drive system. The controllers flash a code to the operator or technician aiding in diagnosing a fault. The controllers allow for a variable speed control on the motors and reversing capabilities for cutting unit maintenance procedures. The controllers and motor are a John Deere exclusive system.

John Deere Turf Care, Raleigh, North Carolina USA; 800-537-8233, www.JohnDeere.com

AE50 OUTSTANDING



INNOVATIONS 2005

● Pulse-width modulated valves uniformly meter liquid fertilizer

The N-Ject LF™ system, developed by Capstan Ag Systems, utilizes pulse-width modulated valves to meter liquid fertilizer to each knife or coulter on the tool bar. The pulse-width modulated valves, coupled with the Wilger flow indicators, offer simple, accurate metering and uniformity across the tool bar with variable rate ranges of 25:1 and sectional control for irregular fields and point rows. The flow control range of the N-Ject LF™ is ideal for variable rate applications with a larger operating range than pressure-based flow control.

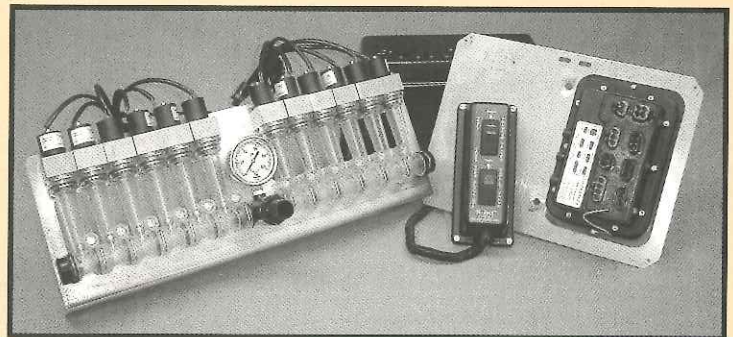

Capstan Ag Systems, Inc., Topeka, Kansas USA; 785-232-4477, www.capstanag.com

● Nozzle improves chemical savings, boasts spray productivity and environmental protection

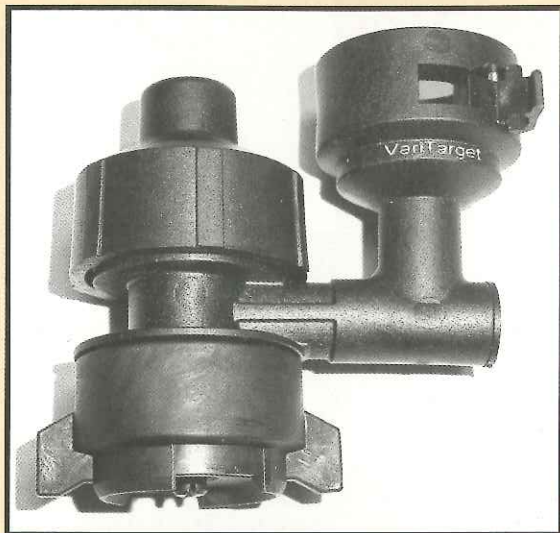

The flow rate of the VariTarget nozzle is variable from 0.57 to 3.03 L/min (0.15 to 0.80 gpm) as spray pressure varies from 103 to 344 kPa (15 to 50 psi); thus, one VariTarget nozzle can replace eight conventional drift reduction nozzles. The VariTarget nozzle significantly improves chemical savings, spray productivity, and environmental protection. Spray speeds from 2 to 24 per hour and application rate from 5 to 40 gallons per acre are quickly achieved on the go with one nozzle. Droplet size of the VariTarget nozzle over the range of flow rates is optimized to provide superior efficacy and effective drift reduction. Spray angle and spray distribution is constant over the range of flow rate to provide uniform spray coverage along the spray boom and travel direction. The VariTarget nozzle self-adjusts between rates and self-cleans to significantly reducing plugging. The nozzle fits conventional nozzle bodies and is adaptable to most conventional spray systems. The

VariTarget nozzle can control flow rate on spray systems with manual pressure regulators or with an automatic rate controller. It can be used with GPS/GIS for precision application of crop protection materials and fertilizer.

SprayTarget, Rosemount, Minnesota USA; 651-544-3227, www.spraytarget.com

AE50 OUTSTANDING



INNOVATIONS 2005

● Performance peaks with pre-separation action



Each LEXION 500R model features a unique blend of multi-cylinder threshing combined with twin-rotary separation to achieve total machine balance and optimized performance in all conditions. The patented accelerated pre-separation system (APS) is comprised of a tri-cylinder design with total under-shot feeding to effectively thresh and meter crop material at a constant speed, width, thickness, and angle to the twin-rotary separation system. Each system is independently adjustable from the cab via variable speed drives. Due to pre-separation action, the threshing system requires minimal configuration changes between crops with total machine crop settings programmable from the cab.

CLAAS Omaha LLC, Omaha, Nebraska USA;
402-861-1000, www.lexioncombines.com

● New products/programming software control off-highway equipment

The Sauer-Danfoss PLUS 1™ system includes a new family of control products and programming software specifically designed for the control of mobile, off-highway equipment. With both hardware and software designed in modules, PLUS 1 is easily configured and endlessly expandable. Sauer-Danfoss has designed the PLUS 1 control system hardware to be extremely flexible as well as cost effective. Stackable microcontrollers and I/O modules are available in three housing sizes and nine I/O configurations for multiple control options – providing the building blocks for nearly any function. DSP technology and CAN-based communications assure state-of-the-art control performance. Mounting flexibility and durable design provide more options in machine design – even for the harshest operating environments. Using the powerful PLUS 1 GUIDE (Graphical User Integrated Development Environment), engineers can quickly build customized applications from the Sauer-Danfoss library of software control objects. The “ready-to-fit” platform reduces the cost and development time normally associated with programming. The PLUS 1 GUIDE also offers diagnostic tools and customizable service interfaces.

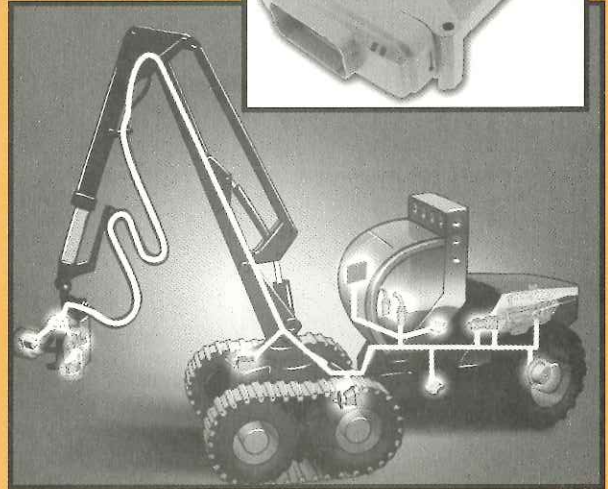

Sauer-Danfoss, Minneapolis, Minnesota USA; 515-956-5750, Nadvertising@sauer-danfoss.com, www.sauer-danfoss.com

AE50 OUTSTANDING



INNOVATIONS 2005

● Mower serves small and hobby farm

The Vermeer TM Rebel Series is a side-pull disc mower used for cutting hay and forage with convenience features for the small and hobby farmer. The TM700 Rebel has a cutting width of 2.8 m (9.2 ft) and the TM800 Rebel, 3.2 m (10.5 ft). Both offer easier drawbar hook up, 20 percent less horsepower requirements, and reduce ground force by 50 percent compared to conventional 3-point disc mowers. The TM mowers center behind the tractor for easy transport in between fields. Low transport removes the load from three point arms and eliminates transport height concerns. The mower offers improved cutterbar floatation and protection with adjustable rubber torsion suspension; no tools are required to adjust it. Lift and swing functions can all be performed from the tractor cab. The drivetrain has been simplified to a direct drive with no belts to adjust, and it is protected by a slip clutch. The weight of the cutting unit is supported by the trailed frame, which improves stability and reduces horsepower requirements.



Vermeer Manufacturing Company, Pella, Iowa, USA; 800-370-3659. www.vermeerag.com

● Operator presence system assures safety



Mitsubishi Forklift Trucks offers a new line of internal combustion cushion tire forklift models that utilize a new "operator presence system" with onboard computer, CANBUS network, sensors, and lockout mechanisms. The operator presence system – the Presence Detection System – reduces risk to both equipment and operator. When the operator gets out of the seat the transmission is automatically placed in neutral position (regardless of where the forward-neutral-reverse directional lever is set); mast and auxiliary hydraulic functions are curtailed; parking brake sets warning alarm sounds and light displays on the instrument panel. When the operator returns to the seat a seat belt reminder alarm sounds and light displays on the instrument panel.

This feature enhances safety when the forklift is operated in high congestion and loading dock areas common to produce, grocery, food processing, and farming operations.

Mitsubishi Forklift Trucks, Houston, Texas USA; 713-365-1000, www.mit-lift.com

AE50 OUTSTANDING



INNOVATIONS 2005

● GPS drift virtually eliminated

StarFire RTK provides a highly robust, centimeter-level-accurate, and repeatable position signal. It uses a local, ground-based reference station that transmits high accuracy corrections to a vehicle StarFire receiver via RTK radios. Because of proximity of the base station to vehicle, nearly all GPS drift is eliminated, and the position is highly repeatable. In order for the base station signal to reach the vehicle, a direct line-of-sight is needed between the two. When the line of sight is broken, RTK Extend — a John Deere exclusive feature, sustains RTK accuracy for up to 15 minutes. This feature permits RTK systems to be used in regions with hills, trees, and other obstructions.

John Deere Ag Management Solutions, Urbandale, Iowa USA; 888-GRN-STAR (888-476-7827), www.johndeere.com



● Sprayer delivers versatility and special features



The John Deere 4920 Self-Propelled Sprayer is a large, versatile, and highly productive machine for application of fertilizers and crop protection products. The 1,200-gallon solution tank and 36.6-m (120-ft) boom, combined with the best vehicle suspension in the sprayer industry, make this machine the most productive sprayer on the market. A John Deere 8.1-liter, 300-hp Power Tech engine ignites the 4920. The hydrostatic drive is controlled electronically so ground speed is automatically maintained at a set point up to 32 kph (20 mph) in the field. Transport speed is 56 kph (35 mph), allowing for rapid travel from field to field. The 4920 is equipped with Solution Command, which

provides automatic control for filling the solution tank, adding chemicals, and rinsing the sprayer. The boom automatically folds for transport with a push of a button in less than one minute. In the field, the boom's seven spray sections can be easily turned on and off with the Index Boom Section control that is integral to the hydrostatic control handle. A long list of additional features makes this machine the top choice for commercial applicators and large farm operations.

John Deere Des Moines Works, Des Moines, Iowa USA; 866-993-3373, www.deere.com

AE50 OUTSTANDING



INNOVATIONS 2005

● Couplers bring ease and speed

Bulldog's 25,000- and 30,000-lb. Gooseneck Couplers make attaching and pulling large gooseneck livestock trailers easier and faster. These are the first gooseneck couplers designed "from the ground up" to meet SAE J2638 Standard. They feature a cast-steel-plate locking system incorporating an integral funnel in the lower locking plate to make hookup alignment easier and faster. Height adjustment is accomplished with a load-bearing pin as compared to the setscrew approach common in the industry. This discrete length adjustment allows higher capacity ratings without applying high torque to the setscrews, which typically hold the vertical load on lower capacity Goosenecks.

Cequent Trailer Products, Mosinee, Wisconsin USA; 715-693-1700, www.cequentgroup.com

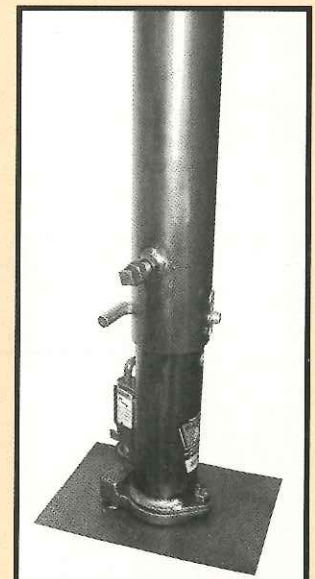

AE50 2005 WINNERS INDEX

AGCO Corporation
GTA Yield Sensor
page 6

AGCO Corporation
**Hesston 9040 Advanced
Conditioner Auger Header,
Challenger AHB TwinMax
Auger Header**
page 18

Cameco, a John Deere
Company
Fixed-Blade Ejector Scrapers
page 14

Capstan Ag Systems, Inc.
N-Ject LF™
page 20

Cat Lift Trucks
**E7000-E12000: 7000-12000
lbs. Capacity Electric Lift
Truck Family**
page 10

Cat Lift Trucks
**NR3000 Series 24-Volt Reach
Trucks**
page 3

Cequent Trailer Products
**BULLDOG® 25,000 & 30,000
lb. Gooseneck Coupler**
page 24

CLAAS Omaha LLC
**C516, 16-row Corn Head
Technology**
page 4

CLAAS Omaha LLC
**Hybrid Processor Tech (Tri-
Cylinder Threshing/Twin-
Rotary Separation)**
page 21

CLAAS Omaha LLC
MaxFlex™ Technology
page 9

CLAAS Omaha LLC
**Multi-finger Separation
System (MSS)**
page 16

CNH America LLC
ASM 24/20 Planter
page 11

CNH America, LLC/New
Holland
**HW-5 Series Speedrower™
Self-Propelled Windrowers**
page 12

Computronics Corporation
Ltd.
Farmscan 5400 Professional
page 17

The CP® Products Company,
Inc.
**CP-65T-S Sprayer Turbo
Nozzle**
page 13

Deere & Company
**4000 Twenty Series Compact
Utility Tractor**
page 3

Faulring Mechanical Devices,
Inc.
Baby Root Hog Harvester
page 8

GK Machine, Inc.
4W6-T Track Sprayer
page 13

Headwall Photonics Inc.
**HyperSpec™ VS Imaging
Spectrograph**
page 19

HYPRO
Versa-Twin 2100 Series Pump
page 4

International Innovative
Technology, Inc.
**Matrix Plant Transfer and
Transplanting System**
page 8

John Deere Ag Management
Solutions
**Harvest Doc Cotton™ Yield
Mapping System**
page 9

John Deere Ag Management
Solutions
StarFire RTK
page 23

John Deere Des Moines
Works
4920 Self-Propelled Sprayer
page 24

John Deere Des Moines
Works
9996 Cotton Picker
page 16

John Deere Des Moines
Works
PRO-12™ VRS
page 7

John Deere Seeding Group
**MaxEmerge™ XP and Pro-
Series™ XP Row Unit**
page 11

John Deere Turf Care
2500E Triplex Greensmower
page 20

Kubota Tractor Corporation
RTV900 Utility Vehicle
page 10

Kubota Tractor Corporation
ZG Zero-Turn Mower
page 15

Leon's Mfg. Company Inc.
ASL Front End Loader
page 19

Mitsubishi Forklift Trucks
**FGC15N-FGC33N 3000-6500
lb. Capacity Internal
Combustion Cushion Tire
Family**
page 23

Nelson Irrigation Corporation
PC-R3000 Rotator®
page 6

Rain Bird Corporation, Agri-
Products Division
LF1200™ Series Sprinkler
page 18

Sauer-Danfoss
**PLUS 1™ Microcontrollers
with GUIDE Programming
Software**
page 22

Spectrum® Technologies Inc.
Spec7 Pro™ Software
page 7

SprayTarget
VariTarget™ Nozzle
page 21

The Toro Co.
**Workman e-2050 Electric
Utility Vehicle**
page 5

Vermeer Manufacturing
Company
600 M Series Baler
page 5

Vermeer Manufacturing
Company
Paddle Tine Conditioner
page 15

Vermeer Manufacturing
Company
R2800 TwinRake
page 17

Vermeer Manufacturing
Company
**TM Rebel™ Series Disc
Mowers**
page 22

Walla Walla Sprinkler
Company, subsidiary of
Nelson Irrigation
Corporation
MP1000 Rotator® Sprinkler
page 12

Weasler Engineering, Inc.
Compact Automatic Clutch
page 14



AE50 Outstanding Innovations 2005

Published by

**ASAE – The Society for engineering in agricultural, food,
and biological systems**

2950 Niles Road, St. Joseph, MI 49085-9659 USA

269-429-0300 • fax 269-429-3852 • hq@asae.org • www.asae.org

Pull Out and Save

Resource

Engineering & Technology for a Sustainable World

Guide to Consultants

2005

Guide to Consultants 2005

This Guide to Consultants is presented as a service to people interested in agricultural/biological engineering assistance. This listing is not an offer or advertisement to provide engineering services in any state or jurisdiction where the professional engineer or professional engineering firm is not registered/licensed. All information was provided by the listed consultant. The American Society of Agricultural Engineers (ASAE) assumes no responsibility for the validity of the qualifications listed or the consulting services performed.

The Guide includes listings for registered professional engineers and consultants who are not registered engineers. In the United States the registration/licensing of professional engineers is vested in the states/territories. Administration of the relevant laws governing the practice of engineering is assigned to engineering boards. The primary role of these regulatory boards is to protect the life, health, property, and welfare of the public and to ensure that unqualified individuals do not practice engineering. Many other countries also have laws and regulations pertaining to the practice of engineering. When selecting a consultant, it is recommended that any jurisdictional registration/licensing requirements be identified for specific services.

In the following listings, the date after the specialty description is the professional engineer's initial registration date. The state(s) or country in which the consultant is registered follows the date. The consultant's availability is given on the next line, including geographic area of service.

Indication of registration in a single state does not imply that a professional engineer cannot be registered in other states. Most state engineering registration laws and rules are patterned after guidelines prepared by the National Council of Examiners for Engineering and Surveying, P.O. Box 1868, Clemson, SC 29633, USA. Most states have laws that permit a professional engineer to become registered in other states, either temporarily or permanently, without re-examination. Consideration of the consultant should be on the basis of the consultant's qualifications and not on where registered, because many consultants can obtain registration in other states or jurisdictions.

Consultants who are not registered professional engineers may have qualifications and expertise in areas other than those requiring professional registrations. Prospective clients should always confirm, through independent sources, the qualifications of all consultants for the services to be performed.

Consulting Engineers Listings

George Aull, Ph.D., P.E.

Engineering Resources Corp.
P.O. Box 910
Orangeburg, SC 29116, USA
803-536-6808
fax: 803-531-3262
www.ercorp.net

Consultation, evaluation, planning, permitting, and design of agricultural water, waste, and wastewater systems. Investigation and development of agricultural and silvicultural land application plans for livestock wastes, biosolids, and wastewater effluents.

Initial date of registration 1980: NC, SC, GA
Full-time; domestic.

Isaac Avitan, Ph.D., P.Eng.

Avitan & Associates, Inc.
772 Brookshade Parkway
Alpharetta, GA 30004, USA
770-410-7989
fax: 770-410-0335
Isaac@AvitanAssoc.com

Mechanical and electrical engineering consulting services. Patent infringement, product liability, accident/failure analysis, testing, evaluation, reconstruction, simulation, litigation support, and expert witness. Fire cause and origin investigation. Safety warnings, instructions, operating manuals, and technical documentation evaluation and development. Twenty-three years experience research/design/development industrial, agricultural and construction machinery, including ergonomics, standards, and regulations. Initial date of registration 1981: ON (Canada)

Full-time; domestic and international.

Lewis C. Barbe, CSP, CRSP, P.E.

Occupational Safety & Health Services, Inc.
6320 Limerick Lane
Edina, MN 55439, USA
952-941-6319
fax: 952-941-6317
lcb5392@aol.com

Consulting services: formulation and implementation of total loss control programs for products, facilities, equipment, construction and services. Complete engineering analysis and services including safety, human factors, fire protection engineering, ergonomics, laws, rules and regulations.

Initial date of registration 1975: CA, MA, Canada
Full-time; domestic and international.

Consulting Engineers Listings

Wesley F. Buchele, Ph.D., P.E.

Buchele Associates Ltd.
239 Parkridge Circle
Ames, IA 50014-3695, USA
515-292-2933
fax: 515-292-2933 (call ahead)
wbuchele@msn.com

Inventing and teaching of creativity. Consulting services in the design and safe operation of lawn mowers, agricultural equipment, and construction machinery. Investigation and reconstruction of accidents. Will furnish relevant literature and provide expert testimony when needed.

Initial date of registration 1954: IA, CA
Full-time; domestic and international.

William A. Cook, P.E., L.S.

Neosho Engineering & Technology
13700 60th Road
Parsons, KS 67357, USA
620-421-3027

Boundary surveying, topographic surveying, construction staking, land use planning, preliminary planning for water control structures, real estate development, and community planning.

Initial date of registration 1981: KS
Full-time; domestic.

Daniel L. DeHaan, P.E.

DeHaan, Grabs & Associates, LLC
P.O. Box 522
Mandan, ND 58554, USA
701-663-1116
fax: 701-667-1356
danddga@btinet.net
www.dgaengineering.com

Consulting services for planning, design, construction monitoring, and permitting of agriculture production facilities. Services include site investigation, preliminary layouts, engineering surveying, facility design, regulatory permit application, construction staking and construction monitoring for swine, beef, dairy, poultry, bison, and other livestock facilities, soil and water conservation, grain handling facilities, and irrigation design.

Initial date of registration 1994: KS, OK, NE, SD, ND, IA, MT, ID
Full-time; domestic and international.

Robert O. Diedrichs, P.E.

Diedrichs & Associates, Inc.
209 Franklin Street
Cedar Falls, IA 50613, USA
319-266-0549
rdiedrichs@cfu.net

Engineering and design of products, machines and systems. Forty years experience consulting/problem solving related to products, machine controls, manufacturing processes, and product safety. Assembly of prototypes and testing of product performance and durability. Data collection and analysis, strain gage, etc. Evaluation of concepts and preparation of cost estimates. ProE, AutoCAD, Inventor, and Solidworks.

Initial date of registration 1964: IA
Full-time; domestic and international.

Terry Feldmann, P.E.

Maurer-Stutz, Inc.
7615 N. Harker Drive
Peoria, IL 61615, USA
309-693-7615
fax: 309-693-7616

tlfeldmann@maurerstutzinc.com

Consulting, evaluation, planning and design services for livestock and poultry production facilities including expansion, site development, feasibility studies, renovation, ventilation and heating, environmental monitoring, product development, field research, manure handling/storage/treatment, permitting, nutrient management, odor assessments, equipment/material specifications and earthwork quantities. Expert witness testimony. Experience includes swine, dairy, turkeys, broilers and beef.

Initial date of registration 1998: IL, IN
Full-time; domestic and international.

G. Jason Furrer, P.E.

Furrer FAB Designs
7762 E 900N
Remington, IN 47977, USA
219-261-4231
fax: 219-261-2809

jason@furrerfabdesigns.com
www.furrerfabdesigns.com

Wastewater storage and handling design. Product development services using Pro/Engineer or SolidWorks.

Initial date of registration 2001: IN, IL
Full-time; domestic.

John A. George, P.E.

Agricultural Engineering Associates
1000 Promontory Drive
Uniontown, KS 66779, USA
620-756-1000
fax: 620-756-4600

johng@agengineering.com
www.agengineering.com

Livestock and crop research test and production facilities consulting and design including facilities for swine, beef, dairy, poultry, horses and other non-ruminant species; waste management systems; soil and water conservation and resource development; grain and feed storage, drying and processing facilities; irrigation system evaluation and design. Site investigation, geologic borings, computerized survey and topographic mapping.

Initial date of registration 1974: KS, IA, IN, MI, MO, CO, SD, NE, IL, OK, OH, TX, AR, ND, OR, MT, WA, NM, WY, AL

Full-time; domestic and international.

Gregory G. Grabs, P.E.

DeHaan, Grabs & Associates, LLC
P.O. Box 522
Mandan, ND 58554, USA
701-663-1116
fax: 701-667-1356

greg@dgaengineering.com
www.dgaengineering.com

Consulting services for all species of production livestock facility design, including site assessment and feasibility studies; topographical surveying; preliminary designs, geological investigation; site development plans; regulatory submittal and permitting; construction bidding, staking, management, inspection, and certification. Experience also includes watershed modeling, drainage, and soil and water conservation design.

Initial date of registration 1995: KS, CO, MO, WY, SD, ND, WI, NE, MN

Full-time; domestic and international.

Consulting Engineers Listings

Ted A. Gribble, P.E.

Five-G Consulting
P.O. Box 30940
Reno, TX 75462, USA
903-783-9995
fax: 903-784-2317
fiveg@neto.com
www.fiveg.com

Consulting and engineering for livestock facilities. Specialize in dairy and food processing waste systems. Experience worldwide in all climates.

Initial date of registration 1998: OR, NE, HI, NY, PA, TX, UT
Full-time; domestic and international.

Dale M. Gumz, CSP, P.E.

Inductive Engineering
10805 230th Street
Cadott, WI 54727-5406, USA
715-289-4721
fax: 715-289-4722

Engineering consultant for agriculture, construction, consumer products, and specialty machines. Forensic and safety services include: accident reconstruction, safety responsibilities, human factors, manufacturing processes, mechanical and electrical, occupational safety, product liability, product and machine design analysis. Experience includes a farm background and safety and design engineering since 1970, manufacturing, safety, and forensic engineering. NCEES, CSP.

Initial date of registration 1975: IL, IA, MO, WI
Full-time; domestic and international.

Victor L. Hauser, Ph.D., P.E.

13214 Hunters Breeze
San Antonio, TX 78230, USA
210-493-7527
victor.hauser@worldnet.att.net

Consulting services for planning, design, construction, monitoring and permitting of alternative landfill covers, ground water remediation, phytoremediation, water conservation, erosion control, grass establishment, and hydrology. Original creator of the evapotranspiration (ET) landfill cover. Conducted original research on the conservation bench terrace, ground water recharge, surface runoff and grass establishment.

Initial date of registration 1959: TX
Full-time; domestic and international.

Jeffry W. Healy, P.E.

Banning Engineering, P.C.
698 Tower Road, Suite 100
Plainfield, IN 46168, USA
317-839-2581
fax: 317-838-9171
jhealy@banning-eng.com

Consulting, planning and design for drainage, irrigation, and agricultural waste management systems. Hydraulics, hydrology, dam safety evaluations and rehabilitation. Surveying, site planning, development, and design for agricultural, commercial, and residential. GPS surveying.
Initial date of registration 1984: IL, IN, IA, MI, OH, OK
Full-time; domestic and international.

George W. Hicks, P.E.

Ingenium Engineering Services
4345 Teal Road
Petersburg, MI 49270-9304, USA
734-279-9345
fax: 734-279-1788
gwhicks@umich.edu
www.ingeniumservices.com

Mechanical or motor vehicle engineering and consulting. Certified Traffic Accident Reconstructionist and accredited OSHA safety course instructor. Fire investigations of vehicles and equipment. Vehicle or component test and development; safety standards evaluation, vehicle testing (on-road and off), and trailer towing are a specialty. Litigation assistance; consultant or expert. Familiar with handicapped adaptive devices used on agricultural equipment.
Initial date of registration 1992: MI, OH, PA
Full-time; domestic and international.

David R. Hundebly, P.Eng.

Hundebly Consulting Ltd.
RR 4, Box 198
Saskatoon, SK, S7K 3J7, Canada
306-242-6858
fax: 306-249-1366
hundebly@sasktel.net
www.hundebly.com

Inventing, consulting, and forensic engineering services specializing in global design and analysis of agricultural implements and machinery (over 60 international patents). "Expert witness" regarding dry land and row crop equipment in North America, Australia, and Europe. "Prior art" research and patent litigation courtroom experience. Assistance concerning European CE certification and road

traffic homologation. Actively involved in farming operation.

Initial date of registration 1993: SK (Canada)
Full-time; domestic and international.

Larry R. Johnson, P.E.

Oakwood Engineering LLC
W7975 Oakwood Lane
Fort Atkinson, WI 53538, USA
920-563-3371
fax: 920-568-1228
ljohnson@ticon.net

Consulting services for agricultural, construction, food processing, and outdoor power equipment. Services include product safety program development, safety evaluations of equipment and product documentation, claims management, and expert witness testimony. Litigation experience in personal injury, product performance, contracts, trade dress, patent and trademark issues. Over 30 years experience in operations and engineering management.

Initial date of registration 1974: MI, WI
Part-time; domestic and international.

Brent Leatherman, P.E.

Timber Tech Engineering, Inc.
P.O. Box 509, 206 S. Main Street
Kouts, IN 46347, USA
219-766-2499
fax: 219-766-2394
bl@timbertecheng.com
www.timbertecheng.com

Structural engineering and design of post frame buildings including foundation posts, roof systems, and wall systems. Design of manufactured wood products including glued laminated beams, arches, and "mortise and tenon" timber frames. Agricultural engineering including livestock confinement housing, farmstead planning, manure handling systems, ventilation, and mechanical design. Drafting services and building code review.

Initial date of registration 2001: IN, MI, WI
Full-time; domestic.

Consulting Engineers Listings

Jeffery C. Lorimor, Ph.D., P.E.

Project Manager, Curry-Wille & Associates,
Consulting Engineers, P.C.

P.O. Box 1732
Ames, IA 50010, USA
515-232-9078
fax: 515-232-9083

Consultation on confinement and open lot animal waste management systems including water quality and air quality issues, drainage and irrigation systems, soil conservation structures, soil and water conservation planning, water supply, recreational land and water development, and other agricultural environmental engineering issues.

Initial date of registration 1973: IA
Part-time; domestic and international.

Joseph G. "Jake" Martin III, P.E.

Agricultural Engineer
6024 S.W. 89th Terrace
Gainesville, FL 32608, USA
352-371-4655

fax: 352-371-1677
jake@dairydesign.com
www.dairydesign.com

Consulting engineering services for complete dairy facility evaluation, layout, and design. Services provided include: site selection and evaluation; preliminary facility layouts; earth-work modeling and design; dairy expansion evaluation; layout and design of milking centers, housing facilities, working areas, feed centers, and youngstock facilities. Complete waste management system evaluation, layout, and design.

Initial date of registration 1984: LA, GA, FL, KS, AZ, PR, CO, IA, VA, TX, KY, SD, OH
Full-time; domestic and international.

Roger D. Mayhew, P.E.

623 Kohler Drive
West Bend, WI 53090, USA
262-692-9219
mayhewr7@alexssa.net

Consulting in agricultural machinery, lawn and garden equipment, and machine design and testing. Also consulting in ASAE, ISO, SAE standards and patents. Specialize in PTO drive lines for machinery. Forty-three years experience in design and testing of agricultural machinery and lawn and garden equipment. Over 30 years experience in standards development for ASAE, ISO, SAE, and OPEI.

Initial date of registration 1994: WI
Part-time; domestic.

Stewart W. Melvin, Ph.D., P.E.

Project Manager, Curry-Wille & Associates,
Consulting Engineers, P.C.

P.O. Box 1732
Ames, IA 50010, USA
515-232-9078
fax: 515-232-9083

Consultation on confinement and open lot animal waste management systems including water quality and air quality issues, drainage and irrigation systems, soil conservation structures, soil and water conservation planning, water supply, recreational land and water development, and other agricultural environmental engineering issues.

Initial date of registration 1969: IA
Part-time; domestic and international.

James M. Miller, Ph.D., P.E.

Miller Engineering Associates
2392 Fuller Court
Ann Arbor, MI 48105, USA
734-662-6822

fax: 734-747-9712
mail@millerengineering.com
www.millerengineering.com

Hay, crop, and grain harvesting and storage; dairy and food processing safety; tractor, implement, and harvester safety; farm accident reconstruction; agricultural chemical safety; pesticide use, compliance, disposal, and contamination; equine and bovine accidents; roadway/highway accident reconstruction; slips, falls — premise, vehicle, ladder; design of user manuals, labels, and warnings; OSHA compliance.

Initial date of registration : MI, ID, OR
Full-time; domestic.

Rodney M. Nohr, P.E.

NOHR Engineering Company
Suite 200, The Wagner Building
307 Walnut Street
Yankton, SD 57078, USA
605-665-1214

fax: 605-665-8060
nohren2@iw.net
www.nohrengineering.com

Engineering design, evaluation, and engineering reports for ag business, commercial, farm, industry, and insurance clients. Projects include engineering for grain and bulk materials handling, storage and processing equipment, structures, bins, silos, and processes; agricultural field and livestock equipment, structures,

and processes; fire, explosion, failure, and damage investigations and reports.

Initial date of registration 1976: AZ, AR, CO, IN, IA, KS, ME, MI, MN, MS, MO, MT, NE, NM, NH, ND, OH, OK, SD, TX, VT, WI, WY

Full-time; domestic and international.

Richard L. Parish, P.E.

Richard L. Parish, PE, LLC
21135 Highway 16
Amite, LA 70422, USA
985-543-4125

fax: 985-748-3813
rlp70422@aol.com

Consulting and expert witness testimony in patents and product safety/performance/evaluation involving agricultural, grounds maintenance, and lawn/garden equipment. Experience with a wide range of agricultural and horticultural equipment. Past cases in patents, personal injury, wrongful death, product performance, advertising. Thirty-six years experience in engineering, engineering management, research, teaching, and consulting.

Initial date of registration 1973: OH
Part-time; domestic and international.

Jonathan C. Popp, P.E.

Popp Engineering, Inc.
2710 Ford Street
Ames, IA 50010, USA
515-232-6118

fax: 515-232-8814
jpopp@poppengineeringinc.com
www.poppengineeringinc.com

Professional engineering and project management services are provided to the seed and related industries. These services encompass renovation and new construction, specializing in seed drying, air handling equipment, and dust control problems. All phases of projects from problem analysis and design to equipment procurement and construction leadership are provided to customers.

Initial date of registration 1993: IA, IL
Full-time; domestic.

Consulting Engineers Listings

Sybren Y. Reitsma, Ph.D., P.E.

Lacto-Tech Service
1025 Esdras Place
Windsor, ON N8S 2N1, Canada
519-974-9193
fax: 519-974-9434
lacto@sympatico.ca

Machine milking investigations relating design, installation, operation and management to loss of milk and cows. Measurement and analysis of various types and designs of milking systems. Assistance in product liability and safety. Research experience at organizations in several countries and practical experience.

Initial date of registration 1982: ON (Canada)
Part-time; domestic and international.

Rodney Rinehart, P.E.

Project Manager, Curry-Wille & Associates,
Consulting Engineers, P.C.
P.O. Box 1732
Ames, IA 50010, USA
515-232-9078
fax: 515-232-9083
rrinehart@currywille.com

Consultation on agricultural experiment stations, commercial and private facilities housing livestock and poultry, and research facilities. Services include designs, plans, and specifications for the general, structural, mechanical, and electrical portions of the projects, including site development, utilities, and waste handling.

Initial date of registration 1997: IA, IA
Full-time; domestic and international.

Lawson M. "Mac" Safley Jr., Ph.D., P.E.

Agri-Waste Technology, Inc.
5400 Etta Burke Court
Raleigh, NC 27606, USA
919-859-0669
fax: 919-233-1970
agriwaste2@aol.com
www.agriwaste.com

Consulting, planning, and design of waste management plans for poultry and livestock complexes, industries, and municipalities including ongoing records management and assistance with regulatory compliance. Registered P.E. in 35 states and Saskatchewan, Canada.

Initial date of registration 1981: TN
Full-time; domestic and international.

Robert B. Skromme, P.E.

7440 State Route 703
Celina, OH 45822-2836, USA
419-586-1227
fax: 419-586-6144

Consultant and expert witness in patent infringement, product liability, product performance, and safety management. Technical expert support on agricultural, industrial and outdoor products; standards and regulations. More than 40 years experience.

Initial date of registration 1968: WI
Full-time; domestic and international.

Russ Stammer, P.E.

SEH Inc.
3240 East River Road NE
Suite 102
Rochester, MN 55906-3422, USA
507-529-7200
fax: 507-529-7201
rstammer@sehinc.com
www.sehinc.com

Consulting engineering services for agricultural waste handling and storage, manure and nutrient management, permitting, site design, drainage, food processing waste and wastewater treatment, egg production wastewater treatment, odor control, biofiltration, planning, design, construction observation, construction management, spray irrigation design, and structure design.

Initial date of registration 1986: IA, MN, NE
Full-time; domestic and international.

Andrew W. Wedel, P.E.

McLanahan Corp.
200 Wall Street
Hollidaysburg, PA 16648, USA
814-695-9807
fax: 814-695-6684
awedel@mcclanahan.com
www.mclanahan.com

Design of sand-laden manure conveyance, separation and storage systems. Services also include: procurement of grant funding; design and implementation of best management practices related to nutrient management plans; and laboratory analysis of bedding sand.

Initial date of registration 1999: PA, DE
Full-time; domestic.

Jerry L. Wille, P.E.

President, Curry-Wille & Associates,
Consulting Engineers, P.C.
P.O. Box 1732
Ames, IA 50010, USA
515-232-9078
fax: 515-232-9083
jwille@currywille.com

Consultation on agricultural experiment stations, commercial and private facilities housing livestock and poultry or storing grain and seed. Services include designs, plans, and specifications for the general, structural, mechanical, and electrical portions of the projects, including site development, utilities, and waste handling.

Initial date of registration 1977: IA, OK, IL, KS, OH, ID, CO, MO, MN, MS, WI, NC, KY, NE, PA, SD, IN, MI, NJ, AR, MD, TN, AL, GA
Full-time; domestic and international.

Donald W. Wright

Microanalytics (A MOCON Company)
2011 A Lamar Drive
Round Rock, TX 78664, USA
512-218-9873
fax: 512-218-9875
don.wright@mdgc.com
www.mdgc.com

Odor analysis, consulting and instrument integration services utilizing optimized GC-olfactometry and GC-MS technologies. Malodor investigation experience base includes: environmental, food, beverage, and consumer products. Specializing in rapid response to crisis driven consumer complaint issues; detecting, isolating, identifying, and tracking primary odorant compounds within an environment, product, or process.

Full-time; domestic and international.

Dale Wm. Zimmerman, P.E.

President, Mock, Roos & Associates, Inc.
5720 Corporate Way
West Palm Beach, FL 33407, USA
561-683-3113
fax: 561-478-7248

Engineering, surveying, planning, including reports, permitting, design and construction phase services for agriculture; land development; public works; water control districts; stormwater management; irrigation; pump stations, potable water and wastewater systems and treatment; water wells; environmental assessment; best management practices; waste management; water quality monitoring; mapping, CAD, GIS, and GPS.

Initial date of registration 1969: FL

Professional Service Card Listings



DeHaan, Grabs & Associates, LLC

Consulting Engineers
PO Box 522, Mandan, ND 58554
(701) 663-1116, FAX: (701) 667-1356
www.dgaengineering.com

DANIEL L. DEHAAN, P.E. GREGORY G. GRABS, P.E.

- Dairy, Bison, Beef, Swine and Other Production Livestock Facility Layout, Design, Regulatory Permitting and Construction Development
- Best Management Practices, Waste Management Plans and Pollution Prevention Plans
- Environmental Audits and Assessments

Irrigation and Wastewater Systems
Sales and Engineering/Design

www.IRRIGATION-MART.com



MEMBER

300 S. Service Road, E.
Ruston, LA 71270-3440
Ph: 800-SAY RAIN (729-7246)
318-255-1832
Fax: 318-255-7572
sales@irrigation-mart.com



we SAVVY Irrigation

Jackie Robbins, CEO, CID, Ph.D., Agricultural Engineer, P.E.
Jay Robbins, Agricultural Engineer, EI
Robin Robbins, Agronomist

Rodney M. Nohr, P.E. Consulting Engineer

USA and International design of Grain, Feed and Bulk Materials handling, storage and processing equipment, bins and silos.

Suite 200, The Wagner Building
307-309 Walnut Street
Yankton, South Dakota 57078-4344

Tel: (605) 665-1214 E-Mail: nohren2@iw.net
Fax: (605) 665-8060 http://www.nohrengineering.com

INDUCTIVE ENGINEERING

DALE GUMZ, P.E., C.S.P.
715-289-4721

10805 230th Street
Cadott, WI 54727-5406

- Accident Reconstruction
- Mechanical & Electrical
- Safety Responsibilities
- Product & Machine Design

Mock, Roos & Associates, Inc.

Engineers • Surveyors • Planners

Agricultural and Environmental Engineering
Soil and Water • Citrus • Dairies • Waste Management
Environmental Assessment • Best Management Practices
Farm Structures • Pump Stations • Agri-Businesses & Farm Plans • Permitting and Design • Water Quality Monitoring • Mapping, CAD & GIS

Dale Wm. Zimmerman, P.E.
President and Managing Principal
5720 Corporate Way • West Palm Beach, Florida 33407
Phone (561) 683-3113 ext. 214 • FAX (561) 478-7248



Agricultural Engineering Associates

1000 Promontory Dr.
Uniontown, KS 66779
(620) 756-1000

John A. George, P.E.

www.agengineering.com

- Swine Production Facilities
- Beef Feedlots
- Dairy Facilities
- Waste Management Systems
- Livestock Research & Test Facilities
- Soil & Water Conservation Design & Resource Development
- Irrigation Systems Evaluation & Design
- Geologic & Site Investigations
- Soils & Concrete Testing Lab



Agri-Waste Technology, Inc.

"Concepts in
Agricultural Byproduct Utilization"

L.M. (Mac) Safley, Jr., Ph.D., P.E.
President

5400 Etta Burke Court
Raleigh, North Carolina 27606
Phone: (919) 859-0669 Email: agriwaste2@aol.com
Fax: (919) 233-1970 Consulting Engineering

DIEDRICHS & ASSOCIATES, Inc.

"Solutions to Technical Problems"

Product and Machine Design
Ag Vehicles and Power Transmission
Prototype Build, Test and Evaluation

R. O. Diedrichs, P.E. 319-266-0549
209 Franklin St. Cedar Falls, IA 50613
www.diedrichsandassociates.com

ROBERT B. SKROMME, P.E. Consulting Engineer

7440 State Route 703
Celina, Ohio 45822-2836
Phone: (419) 586-1227
Fax: (419) 586-6144

- Expert Witness
- Product Liability
- Product Safety
- Standards & Regulations
- Patent Infringement
- Product Performance



GREENHOUSE & CONSERVATORY DESIGN AND ENGINEERING

RESEARCH, EDUCATIONAL, CONSERVATORY & BOTANICAL
GARDEN DESIGN SERVICES

Ananda Bethea
5513 Vine Street Ph: 1 (800) 543-7351
Cincinnati, Ohio 45217 Fx: 1 (513) 242-0816
www.roughbros.com Direct: 1 (513) 618-7261



CURRY-WILLE & ASSOC. CONSULTING ENGINEERS P.C.

Animal and Livestock Facility Design
Feed and Grain Processing and Storage
Fertilizer/Pesticide Containment Design
Agricultural Research Facilities

AMES, IA Lakeville, MN
515-232-9078 612-469-1277
WWW.CURRYWILLE.COM

Victor L. Hauser, Ph.D., P.E. Consulting Engineer

ET 13214 Hunters Breeze
Landfill San Antonio, Texas 78230
Covers Phone: (210) 493-7527
e-mail: victor.hauser@worldnet.att.net

- Alternative landfill covers
- Water conservation
- Erosion control
- Dryland crop production
- Phytoremediation
- Grass establishment
- Hydrology
- Ground water



Offices Nationwide
800-229-6655
trinityconsultants.com

Trinity assists industrial facilities with a host of issues, including:

- Air permitting and compliance assistance
- Environmental management services
- Air dispersion modeling
- Environmental training
- EII&S management solutions



D. Joe Gribble, A.E.
Donald L. Gribble, P.E.
Ted A. Gribble, P.E.

(903) 783-9995
Fax (903) 784-2317

P.O. Box 30940, Reno, Texas 75462
E-mail: fiveg@neto.com • www.fiveg.com

Professional Engineering and Consulting Services for Dairies, Beef Feedlots, and All Types of Agricultural Waste Management Systems

Lennart J. Lindahl, P.E. LBFH, Inc.

Consulting Civil Engineers, Surveyors & Mappers
1(888) USE-LBFH Fax: (772) 286-392
len-l@lbfh.com www.lbfh.com

Lennart is the Director of Water Resources and on the Board of Directors of LBFH, Inc. - one of Florida's top 25 engineering firms. Mr. Lindahl's professional affiliations include: FES, NSPE, AWRA, ASAE, FASD, NMBA, WMI - (Secretary) and the Town of Jupiter - (Planning and Zoning Board Member). He provided technical expertise on the modeling initiatives associated with various aspects of the development of the CERP as well as services related to Special Districts and private development projects for various clients throughout the state of Florida. LBFH specializes in general civil, agricultural and transportation engineering.
Initial Date of Registration: 1999: Florida

WHAT A CONSULTING ENGINEER CAN DO FOR YOU

Because of their broad educational background, consulting agricultural engineers are a source of information on a wide variety of topics and can provide help with diverse technical problems. The design and management services agricultural engineers provide can be invaluable to small businesses without their own engineering departments, to agricultural producers and similar enterprises, and to large businesses or governmental agencies that want to supplement their in-house engineering departments. Consultants also can provide service to lending institutions, law firms, local units of government and planning boards, or to individuals that need expert witnesses or technical analysis.

What is a Consulting Engineer?

A consulting engineer is an independent contractor retained to work on a project-by-project basis. A consulting engineer may work alone or as a member of a consulting firm. Consulting engineers can provide a high level of technical expertise, direct personal service, and highly technical advice. Practicing consulting engineers must be licensed professional engineers in their state of residence and must qualify to obtain licensure in other states where they practice or provide services.

What Expertise Does a Consulting Agricultural Engineer Have?

Agricultural engineers have a diverse educational background that makes them knowledgeable about many subjects; additionally, they usually focus their expertise on one of the following areas:

- Aquaculture
- Biological Applications
- Energy
- Environmental Quality
- Food and Food Processing
- Forestry
- Information and Electrical Technologies
- Power and Machinery
- Safety
- Soil and Water Resources
- Structures and Environment

For more information, please visit www.asae.org/membership/consulting.html.

CODE OF ETHICS OF ENGINEERS

THE FUNDAMENTAL PRINCIPLES

Engineers uphold and advance the integrity, honor and dignity of the engineering profession by:

- I. using their knowledge and skill for the enhancement of human welfare;
- II. being honest and impartial, and serving with fidelity the public, their employers and clients;
- III. striving to increase the competence and prestige of the engineering profession; and
- IV. supporting the professional and technical societies of their disciplines.

THE FUNDAMENTAL CANONS

1. Engineers shall hold paramount the safety, health and welfare of the public in the performance of their professional duties.
2. Engineers shall perform services only in the areas of their competence.
3. Engineers shall issue public statements only in an objective and truthful manner.
4. Engineers shall act in professional matters for each employer or client as faithful agents or trustees, and shall avoid conflicts of interest.
5. Engineers shall build their professional reputation on the merit of their services and shall not compete unfairly with others.
6. Engineers shall act in such a manner as to uphold and enhance the honor, integrity and dignity of the profession.
7. Engineers shall continue their professional development throughout their careers and shall provide opportunities for the professional development of those engineers under their supervision.

2005 Guide to Consultants

Published by

ASAE — The Society for engineering

in agricultural, food, and biological systems

2950 Niles Road, St. Joseph, MI 49085-9659, USA

269-429-0300 • fax 269-429-3852 • hq@asae.org • www.asae.org



ANNUAL INTERNATIONAL MEETING

July 17-20, 2005
Tampa, Florida



IT'S MORE THAN
A MEETING!

JUST

Add It Up . . .

- 130 Technical Sessions**
- + 12 CPD Courses**
- + 227 Posters in Six Divisional Sessions**
- + 5 Technical Tours**
- + 132 Hours of Professional Networking**
- + 175 Committee & Subcommittee Meetings**
- + 4 Days of Product & Service Exhibits**
- + 55 Specialty Activities**

= 1 EXTRAORDINARY EXPERIENCE

See more about the 2005 Annual International Meeting at www.asae.org/meetings/am2005

It's not too late to register online or fax your form to (269) 429-3852

