

**RESOURCE
MAGAZINE'S**

**Outstanding
Innovations 1996**

AE 50 COMPANY RECOGNITION PROGRAM

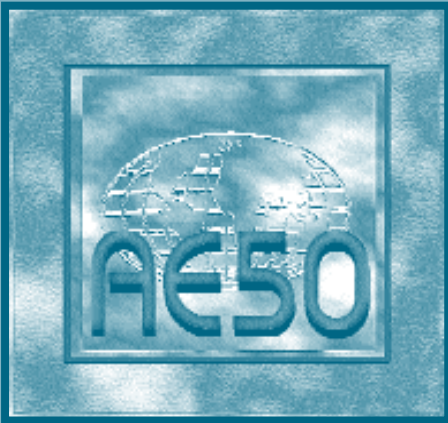

**Nominate your NEW PRODUCT
or SYSTEM for the 1996**

“AE 50” COMPANY RECOGNITION PROGRAM

**The best engineering developments introduced to the agricultural market-
place during 1996 will receive the honor of being named as one of the**

AE 50

outstanding innovations in product or systems technology

**Be sure your engineering efforts and company programs are considered
for the recognition they deserve, and enter the 1997 “AE 50” program!**

***Resource* will present an editorial salute to the companies
and individuals with the most outstanding innovations at the 1997
ASAE Annual International Meeting and publish it in the
August 1997 issue of the magazine.**

**Entry forms will be available in October.
To be placed on the mailing list, write or call:**

**RESOURCE magazine
2950 Niles Rd.
St. Joseph, MI 49085-9659 USA
616-429-6337 • Fax 616-429-3852 • schmitz@asae.org**

A Vision of the Best

Eleven years ago, *Agricultural Engineering* magazine began sponsoring the **AE 50** Company Recognition Program for Innovative Products.

From the start of the **AE 50** program, entries have been solicited from hundreds of diverse companies, large and small, sharing their new designs. The program seeks to bring attention to the products intended principally for use in the production, processing, storage, packing or transportation of agricultural products. Over the years, we've seen many repeat winners with new innovations. The companies who are given this prestigious award are able to display their award-winning product to the public as having been named an **AE 50** recipient.

Each entry is thoughtfully reviewed by a panel of judges selected to represent each area of industry. They identify those products most likely to be of use to those who work as designers, developers, managers or other individuals who are actively involved in engineering for agricultural, food and biological systems.

Read this section to find that product you've been looking for; you may find an idea for a future product of your own to enter.

To the companies, teams and individuals who were actively involved in the conception, design and development of these outstanding products, we salute you!





RoGator 854 with All-Wheel Steering

The RoGator 854 with All-Wheel Steering is a fully automatic four-wheel steering system on a fully hydrostatically driven chassis on which the vehicle track width can be varied dynamically. This system is completely automated and operation is accomplished easily by the operator from inside the cab of the vehicle. The use of two hydraulically activated automatic tie rod cylinders are employed as a means to correct for changing steering acumen and maintaining toe-in during the track width adjustment process. The steering control system incorporates a programmable computer processor to sample and adjust the rear steering cylinder when the system is in the coordinated steer mode. The result is fully coordinated all-wheel steering on a vehicle used mainly for post-emerge, contact herbicide application. **Ag-Chem Equipment Co., Inc.**, Minnetonka, MN USA; 612-945-5813



AgNav Global Positioning System

AgNav is the first robust non-differential navigation system to be provided in the arena of precision farming. One of the critical inputs required to fully attain the maximum economic yield cycle by today's farmer is accurate and dependable location information. Global Positioning System (GPS) and Differential GPS (DGPS) solutions do not provide the level of dependability required in today's precision farming environment. Lost differential signals or satellite blockage are only two of the typical problems resolved with the aid of the AgNav system. Based on the premise that location systems are not adequate for proper application of precision inputs, Ag-Chem Equipment Company undertook the development of a true navigation system with the help of Loral Defense Systems – Eagan, an international technology provider. The result is a robust and dependable system providing performance at least equivalent to DGPS systems, and superior to those systems in congested areas such as around buildings or wooded areas. **Ag-Chem Equipment Co., Inc. / Lockheed Martin™**, Minnetonka, MN USA; 612-945-5826





Gator-Stop Valve

The **Gator-Stop Valve** is designed for instantaneous on and off control of spray nozzles. It is attached to any standard size spray nozzle body on a spray boom for agricultural chemical and fertilizer spraying applications. A compressed air supply is connected to one end of the Gator-Stop valve. The compressed air moves a spool inside the Gator-Stop valve forward to close the flow passage of the spray nozzle body. When the compressed air is released, the pressurized liquid flow pushes the spool backward to open the flow passage. One Gator-Stop valve is attached to each spray nozzle. A certain number of Gator-Stop valves can be grouped together with air lines for one boom section. The use of the Gator-Stop valves will provide section control, allow the liquid booms to remain charged at the normal operating pressure, and eliminate the accumulation effect of entrapped air inside the boom plumbing. The use of this Gator-Stop valve can eliminate cumbersome butterfly or ball valves currently used for boom on-off control for cost and weight reduction of the overall spraying system. **Ag-Chem Equipment Co., Inc.**, Minnetonka, MN USA; 612-945-5813

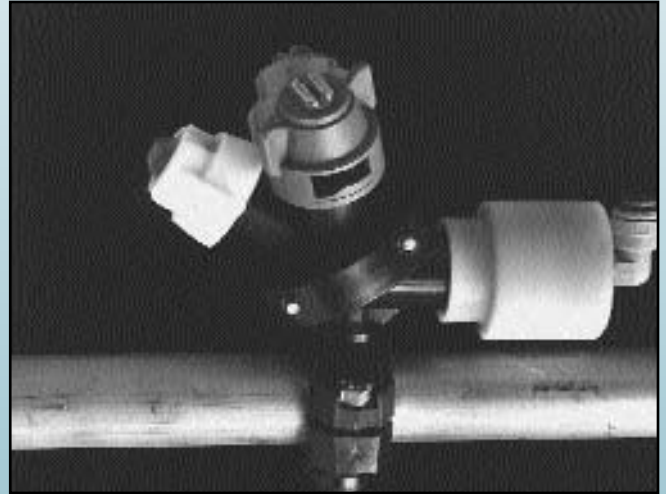

TALON™ Closed Transfer Delivery System

TALON™ (The Total Application Logistics Operating Network) is a comprehensive, closed transfer product delivery system. It allows product applicators to safely deliver products (chemicals) from a bulk tank to the field without tank mixing the concentrated chemicals with the carrier product (water or liquid fertilizer, etc.). This closed transfer feature eliminates the need for in-field tank rinsing, and/or hazardous rinsate on a daily basis, and minimizes the risk of exposing operators to concentrated chemicals. The TALON™ system utilizes a distributed network FALCON™ control system as its controller, an advanced direct product injection sub-system with a triple diaphragm pump, an in-line gear-type flowmeter for real-time dynamic flow control, and Gator-Stop™ valves for each spray nozzle to allow the boom to remain fully charged at the normal operating pressure to eliminate the accumulation effect of entrapped air inside the boom plumbing. The delivery rate can be a constant rate based on vehicle speed, or variable rate based on vehicle speed, and a digital map of application data, crop data and/or survey data, resulting in a system capable of site-specific applications. **Ag-Chem Equipment Co., Inc.**, Minnetonka, MN USA; 612-945-5813





RoGator® 544 – A Self-Propelled Spraying Machine

RoGator® 544 is a self-propelled, precision application machine for spraying liquid fertilizers, herbicides, insecticides and pesticides. The RoGator® 544 is used in production agriculture on all types of crops ranging from corn and soybeans to vegetables and small grains, and it is used primarily by custom applicators. This machine was designed specifically to be very cost competitive in its class of sprayers. Providing the custom applicator market with a low cost machine provides a direct and positive financial impact for both the applicator and the farmer. The challenge for Ag-Chem Equipment Company was to find ways of using the latest technologies in such a way as to accomplish exceptional field performance and produce a low cost machine. These goals were met by incorporating specially machined hydraulic control valves, plastic components and simple but effective computer controls for hydraulic and spraying systems. The result of this effort is a highly efficient, durable and economical machine to operate coupled with a versatile, precision liquid application system. **Ag-Chem Equipment Co., Inc.**, Minnetonka, MN USA; 612-945-5813



New Central Fill Planter is Two Units in One

The new White Model 6800 Series Central Fill Planter entry into the narrow row market offers a machine with the latest technology in conservation and no-till planting. The Model 6800 replaces the no-till planter and no-till drill with one unit that does a superior job of performing both functions. The planter singles corn, soybeans and other seed for optimum placement in the seed trench. Yield increases can be expected from seed accurately spaced and placed precisely at the depth set by the operator. Superior soil-to-seed contact is completed by a choice of planter row unit closing wheels. This unique rigid frame central fill planter positions row units at 30 in. row widths for corn and 10 in. row widths for soybeans, wheat and other seeds. Microprocessor controlled variable seed rate offers infinite seeding rates over a wide range of seed population settings. The ability to adjust the seeding rate on-the-go permits the operator to match seed population to the yield potential of the soil. The large 45 cu. ft. (35 bushel) seed hopper extends operating time between seed fill-ups to further improve operating efficiency. **AGCO Corporation**, Independence, MO USA; 816-836-6360





Massey Ferguson 6100 and 8100 Series Tractors Provide Comfort and Convenience

The Massey Ferguson 6100 and 8100 Series Tractors are the perfect combination of comfort, convenience and technology. Efficient engines and powertrains make these tractors economical to operate. The range includes seven models from 86 to 180 PTO horsepower. All models feature the Quietview cab, one of the most comfortable in the industry. The Dynashift transmission has 32 forward speeds with excellent overlap in all ranges matched to any need. A dependable electronic three-point hitch is simple to operate and provides precise control of mounted implements. Autotronics monitor and control many functions such as four wheel drive, and differential lock with the touch of a button. With modern styling, these are truly tractors for the 21st Century. **AGCO Corporation**, Duluth, GA USA; 770-813-6048



Amadas Introduces New Self-Propelled Peanut Combines

Amadas Industries 9665 SP self-propelled peanut combines are powered by a John Deere drive train including a 235 hp motor, hydrostatic transmission, and optional four wheel drive. The 9665 SP combines harvest six or eight rows of peanuts at a higher rate than that achieved by conventional pull-type harvesters. Inverted peanut vines are lifted from the ground by a six-row or eight-row header mounted on a pivoting feeder house and controlled by an automatic header height control system. The feeder house transfers the material from the header to the picking, separating, and cleaning chambers. Cleaned peanuts are augered to a pneumatic conveyor, which elevates the peanuts to a holding bin while the vines are passed out the back. The 9665 SP was designed and manufactured with the aid of CAD/CAM and CNC machinery. These methods of design and manufacture ensure the quality and reliability of the machine from assembly to harvest. **Amadas Industries**, Suffolk, VA USA; 757-539-0231





Low-Cost MINI Field Station

MINI-RF Stations can be located wherever they are needed for reading sensors or controlling equipment. Communication is in the 900 MHz band, and data can be directly transmitted up to one-half mile to a MINI Base Station or via a MINI Repeater. This low cost, license free, short range radio Field Station is capable of up to four analog (eight bit) sensor inputs, four digital sensor inputs, and four control outputs. The MINI-RF Station can also serve as a Repeater for other MINIs, thereby daisy chaining data longer distances without the overhead cost of a dedicated repeater. A virtually unlimited number of stations can be utilized in a system. The system, including computer and field station, enables large improvements in efficiency and economy of farm and industrial operations. The MINI is available with other styles of radios. **Automata, Inc.**, Grass Valley, CA USA; 916-273-0380

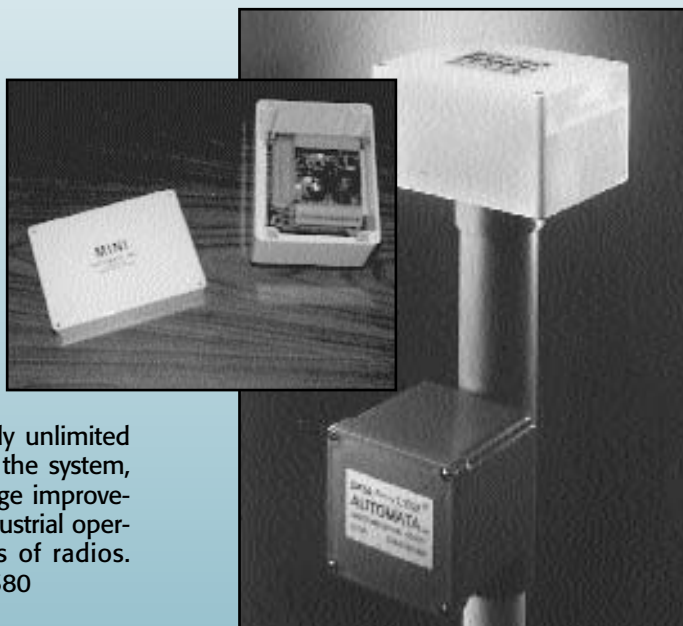

V45 With Cushioned Catching Surfaces Harvests Market-Quality Berries

B.E.I.'s new V45 mechanical blueberry harvester was developed to harvest fresh market-quality berries. The V45 utilizes an angled, double spike-drum direct-drive shaker, and unique cane dividing and positioning system, also cushioned catching surfaces to harvest fruit with minimum damage. The harvester works in traditional blueberry plantings and requires no special cane training. Field evaluations have demonstrated selectivity, recovery, and fruit quality superior to existing commercial harvesters. The V45 causes insignificant damage to the blueberry canes. Fruit quality from the experimental harvester can be as good as commercially hand harvested fruit. **B.E.I. Inc.**, South Haven, MI USA; 616-637-8541





Bou-Matic Meters Milk With Accuracy and Ease

The **Bou-Matic Perfection Milk Meter** is an accurate, compact, full flow milk meter designed for individual cow milk production recording. It is an integral part of the automatic detacher, which removes the milking cluster from the cow. This milk meter contains only one moving component and has no wearing parts. It is designed for ease of service and for clean-in-place washing. **Bou-Matic**, Madison, WI USA; 608-222-3484



Case Combines Best Features for 5500 IH Soybean Special

The **Case 5500 IH Soybean Special** combines the best features of planters and grain drills. This new machine, based on state-of-the-art components, will allow a customer to use no-till, mulch-till or conventional-till seed beds when planting 24 rows of soybeans or other crops at 15 in. (38 cm) row spacing. This machine features the Case IH Early Riser row units, which will allow the farmer to plant moisture with uniform depth control and superior seed-to-soil contact and firming the soil all around the seed. This will maximize yields, resulting in better performance and higher profits. In addition, large capacity seed hoppers eliminates frequent filling stops. The 30 ft. (9.2 m) main frame is hinged in the middle to follow ground contours and folds easily from the tractor cab for narrow transport. **Case Corporation**, Burr Ridge, IL USA; 708-887-2345





Cornell Introduces New Cycloseal™ Irrigation Pump

The 4HC is Cornell Pump Company's first pump in the new "C" series, clear liquids, centrifugal pumps. The 4HC is a high-head water pump with unmatched performance and durability. At 1780 rpm it has efficiency exceeding 76%, a maximum flow rate of 1500 g.p.m., total dynamic head as high as 320 feet, and NPSHR as low as 1 foot. The 4HC is available in frame mount, gear box, close-coupled electric motor, submersible, engine mount, and self-priming configurations. The new "C" series clear liquids pumps are built on Cornell's patented Cycloseal™ platform (U.S. Patent No. 5,489,187), an advanced single seal design developed for solids handling pumps, and designed to handle entrained air or abrasive material in the pumpage. Packing is not an option with these new water pumps, but with the extended seal life and simplified construction available in the Cycloseal™ design, packing may soon become a thing of the past. **Cornell Pump Manufacturing**, Portland, OR USA; 503-653-0330

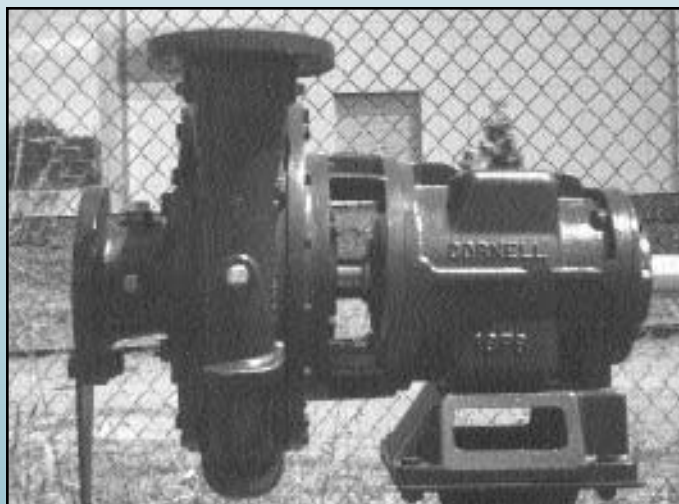

Greenstar™: A Pathway for Farming Operations

The Greenstar™ Yield Mapping System is made up of six basic elements: the display, the mapping processor, the position receiver, the moisture sensor, the yield sensor, and the JDmap software package. With the exception of the yield and moisture sensors, these components are designed to be the foundation for future Precision Farming systems from John Deere. It is the first system publicly announced that includes not only all elements for yield mapping, but a pathway for growth into a system which will include all elements of a customer's farming operation from planting to harvest. **John Deere Precision Farming**, Moline, IL USA; 309-765-7005





1850 No-Till Air Drill Offers High-Speed Capabilities for Productivity

The new John Deere 1850 No-Till Air Drill combines the proven no-till seed placement capability of the 750 No-Till Drill opener with the speed and convenience of a central seed metering and air delivery system. The 1850, which is available in 30-, 60- and 42-ft. working widths and 7.5- or 10-in. row spacings, features a three section vertically folding frame for easy "fold and g" transporting from field to field. The openers are mounted in two ranks and are equipped with the patented "active" hydraulic down pressure system which maintains opener down pressure over varying ground conditions. When combined with the John Deere 787 Air Seeding System, with capacities of 130, 170, and 230 bushels, the 1850 offers high-speed seeding and efficient filling capabilities for high productivity. **Deere & Co., Seeding Group**, East Moline, IL USA; 309-765-2106

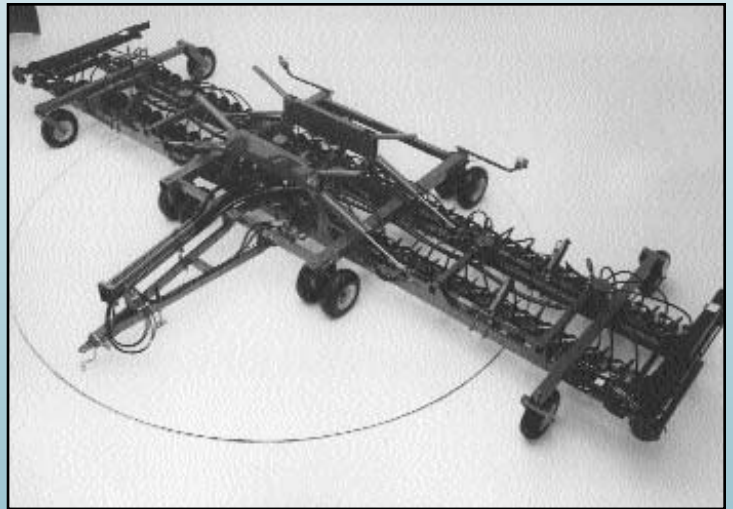

John Deere Introduces Propulsion System with Pneumatic Feel

The John Deere Positive Drive Rubber Track Propulsion System for Combine Harvesters is designed to reduce ground pressure and soil compaction. The unique combination of an air-bag suspension and articulated bogey wheels minimize stress transmitted to the combine by gliding over levies or washouts. The driveability of a combine with the rubber belted track propulsion is very similar to a combine with pneumatic tires. Large oversized steer tires allow positive turning in any condition. In adverse conditions harvesting efficiency is maintained and losses are minimized. In muddy conditions, keeping the combine on the row is easy. Power consumption is significantly less than combines with standard rubber pneumatic tires because they do not cut in or push a wall of mud. The rubber track propulsion system can be either purchased as an option on a new combine or as a bundle to replace the drive tires on an older combine. The existing transmission and hydro are used. No modification of the combine is required. The rubber track propulsion system can be easily removed and converted back to rubber pneumatic drive tires. **John Deere Harvester**, East Moline, IL USA; 309-765-2098

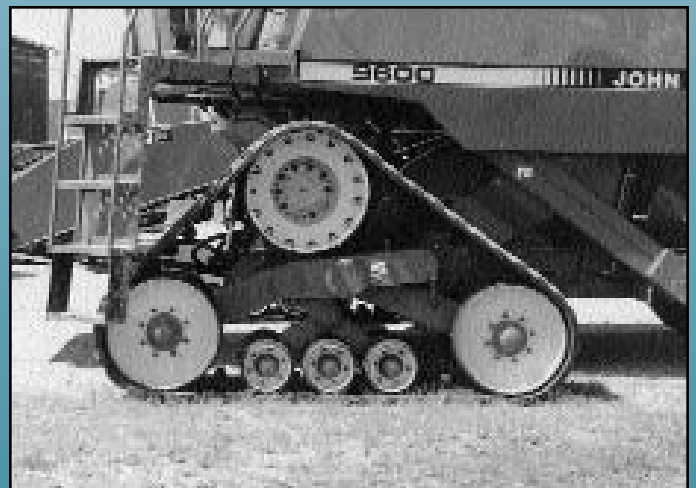



Narrow Row Planter Provides Enhanced Productivity and Precision

The new John Deere 1780 planter provides an enhanced level of productivity to customers planting corn in 30 in. rows and soybeans in 15 in. rows. The machine plants 12–30 in. rows and 23–15 in. rows. The 1780 can easily be converted from 30 to 15 in. row crops. The massive frame is well adapted for conservation tillage and no-till. The machine flexes to follow uneven terrain and folds hydraulically from the tractor operator station. A contact tire drive system keeps all drive shafts and chains above the row units out of residue and soil. The 1780 offers optional 1/2 width drive disconnect, liquid fertilizer capability and low profile tri-fold markers. Field proven John Deere Max-Emerge two row units carrying vacuum meters provide precise seed spacing and depth in a variety of conditions and crops. **John Deere Seeding Group**, East Moline, IL USA; 309-765-2224



Two Stage Infra-Red Heaters Reduce Fuel Costs and Improve Annual Performance

Detroit Radiant Products has long been aware of the benefits of infra-red heating. Getting the source of heat to floor levels, where the people are, improves comfort levels and reduces operating costs. Applying the same technology to an agricultural application was unique in that there is generally a changing heat demand (over time). The **Re-Verber-Ray HL Series Two Stage Infra-Red Heater** provides

more appropriate heat for the larger part of the season. ASHRAE heating data shows that maximum heating output is required for only approximately 5% to 15% of the heating season. This also holds true in swine applications, as less heat is needed as the pigs grow larger. The HL Series will adjust to the changing environment while still providing all of the benefits of infra-red. Documented studies show a more uniform and comfortable environment, improved air quality, reduced energy usage and improved feed ratio and pig performance. **Detroit Radiant Products**, Warren, MI USA; 810-756-0950





Multi-Channel Precision Control System

The **DICKEY-john Precision Control System** is a multi-channel system designed for accurately controlling the application rates of chemicals and other products in agricultural applications. The precision control system consists of a display module, control module, master switch module, ground speed sensor, feedback device(s), actuator device(s) to regulate application rates, and a set of harnesses. The PCS has a multi-level, menu-driven control of system activities and setup parameters via "walk-through" functions and help screens. Audible and visual alarms provide critical and non-critical system or operator errors. These errors are then logged in the alarm history screen for future reference. Operation is in English with other languages becoming available. All system data may be displayed in English, Metric, or a combination of either. There is capability for inclusion of user libraries containing chemical product information and spray nozzle performance parameters for use with the formal reports of application activities. Via an RS 232 port, the PCS has printer output capability, reprogramming through flash memory, and Precision Farming Compatibility. PCS was designed to allow for growth and flexibility as technological improvements become available. Environmental testing was conducted to

industry standards. Meeting the customers needs and expectations were always the main priority. **DICKEY-john Corporation**, Auburn, IL USA; 217-438-3371

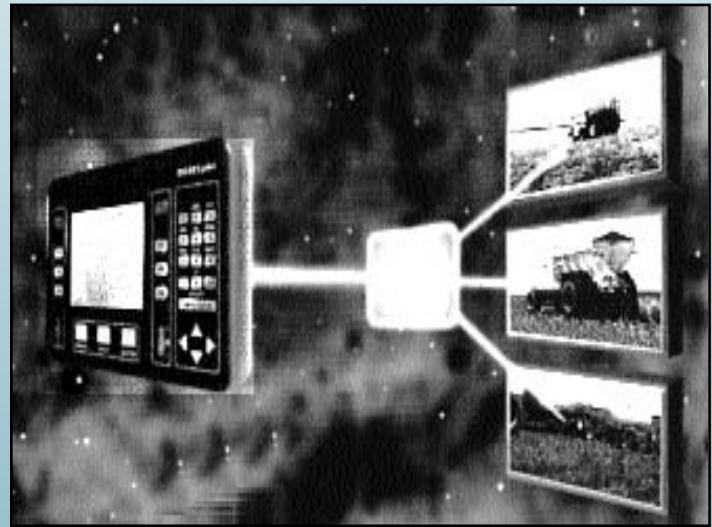

Space Cadet Provides Downloadable Plant Population Data for GPS Correlation

The **Space Cadet** plant population analyzer provides rapid collection of row crop stand data. It measures and displays average population per acre plus standard deviation of individual plant spacings within a sample, and can store up to 99 samples, each containing up to 99 individual spaces. For correlation with GPS, information can also be downloaded via RS-232 to a computer or datalogger as it is collected, or it can be batch downloaded. Because the data collection is very fast compared to manual counting and measuring of plant spacings, much more thorough analysis of crop condition is possible. Factors which influence population and the uniformity of stand includes soil and seed variables, machine condition and settings, biological and chemical competition, and timing of operations. The Space Cadet helps in correlating these factors with the quality of stand, yield, and profitability of the crop. **Easton Goers, Inc.**, Bagley, IA USA; 515-427-5268





Seed Treatment Unit Permits Flexibility in Water-Based Treatments

The **Flexi-Coil Seed Treatment Unit** allows the user to apply water-based treatments to the seed in-the-field, on-the-go, during the seeding operation. It puts the treatment on the seed right before it goes into the soil. There are several reasons why it is an improvement over conventional methods: no leftover seed to dispose of or store; reduced operator exposure to treated seed; timely application; and better seed coverage. The Seed Treatment Unit mounts between the seed cart and the tillage implement. It consists of mixing chambers, a motor/pump assembly, a treatment tank, and a monitor controller. During operation, seed is metered from the seed cart tank into individual primary lines. Each primary line is connected to a mixing chamber. An air stream pneumatically conveys the seed from the seed cart meter to the mixing chamber, where the treatment is applied evenly to the seed. The seed continues travelling to the tillage implement and to the soil openers to be placed into the soil. A self-priming, positive displacement, peristaltic pump meters the treatment from the liquid tank to the mixing chambers. The monitor/controller, mounted in the tractor

cab, controls the treatment rate electronically. The treatment unit monitor starts and stops treatment when the seed cart meter starts and stops. Application rate is automatically adjusted as ground speed changes. **Flexi-Coil Ltd.**, Saskatoon, SK, Canada S7K 3S5; 306-934-3500



HydroSeeders® Designed to Spray Heavy Slurries for Seeding and Erosion Control

The **Finn T90 and T120 Series II HydroSeeders®** are portable spraying units which will apply seed, fertilizer and/or lime, wood fibermulch, and stabilizing materials in any prescribed or desired combination. The materials placed in the HydroSeeder® slurry tank are mixed with water and kept in suspension by a dual agitation process – recirculation of slurry and mechanical agitation – thus forming a slurry that is pumped to the discharge assembly and directed onto the seedbed via hose or discharge boom. Design innovations on these new HydroSeeders® include a direct drive clutch/pump configuration and a full platform tower for ease of operation. **Finn Corporation**, Fairfield, OH USA; 513-874-2818





Unique Concept Machine Increases Efficiency of Potato Windrowing

The Gallenberg Self-Propelled Windrower was designed to increase the efficiency of potato windrowing, increase crop quality and reduce operator fatigue. The machine can dig three, four or six rows. The unique split discharge evenly distributes the potatoes in the harvester row instead of piling all the potatoes into one row. This minimizes the load on the harvester and allows the grower to travel faster because the potatoes "dry down" quicker with the even distribution. The unit has the potential to replace two tractors and two windrowers. The windrower is a concept machine. The "pusher unit" will be adapted to a universal drive system in 1996. The drive system can be used for windrowers, planters, cultivators, side dressers, and many other processes that currently require a tractor and attachment. We see the most market potential in the row crop industry, however, this idea may be adapted to other uses as well, tapping into the tractor market. **Gallenberg Equipment, Inc.**, Antigo, WI USA; 715-623-3754



Total Mix TMR Mixer

Gehl "Total Mix" TMR mixer feeders allow more long-stemmed hay to be mixed into the ration -- up to 30% by weight depending on hay type and moisture. Gehl's design incorporates four unique knife assemblies as an integral part of the two bottom augers. These assemblies break up long hay material for a quicker mix with less chance of wrapping. Gehl's proven four-auger system is known for exceptional blending and mixing of all feed ingredients in much less time. The new auger design delivers that same kind of fast-mixing action in a wider variety of feed materials. From the improved planetary drives that power the four mixing augers to the hydraulically driven unloading conveyor, these rugged, cost-effective mixer feeders deliver top performance. Five models have struck capacities ranging from 210 to 455 cubic feet. The two larger models are also available as truck-mount units. **Gehl Company**, West Bend, WI USA; 414-334-6680





New Bale Control System Allows Adjustments From the Seat

Gehl's **Total Density Control** design has always been a simple, efficient system to make quality round bales. One major improvement is Gehl's auto-electric packaging system featuring a new Bale Control System. This system monitors the complete baling function while allowing the operator to make baler adjustments from the tractor seat. The easy-to-read digital screen and audible alarm keeps the operator aware of the entire baling operation. With the Bale Control System you select manual or automatic control, twine or net wrap (if the baler is equipped with Gehl's Quick-Wrap option), number of wraps, placement of twine and bale diameter. The monitor's electronic readout shows bale growth, tail-gate position and daily bale count. In addition, the Bale Control System functions as an electronic trouble shooter. Ten error codes, programmed into the system, alert the operator to problems that may occur, anything from being out of twine or netting, an obstruction to the twine arm or even low voltage. **Gehl Company**, West Bend, WI USA; 414-334-6657



Cut-Out Clutch Automatically Resets after Protecting Driveline from Overload

The **Walterscheid K66 Key-type Cut-out clutch** is an overload device that protects expensive gearboxes and driveline components by disconnecting power when an overload occurs. It is primarily applied when overloads result from blockage or stoppage of a subsystem. It differs from traditional friction or ratchet clutches in that torque is reduced to a small fraction of the original level. This reduces the load on downstream components and increases the life of the clutch when prolonged slippage occurs (such as when operator response time is not immediate). It offers additional operator safety and productive efficiency by automatically resetting when the driveline is stopped and restarted. The operator is not required to enter the working part of the machine, or even to leave the tractor cab. **GKN Walterscheid, Inc.**, Burr Ridge, IL USA; 708-887-7022

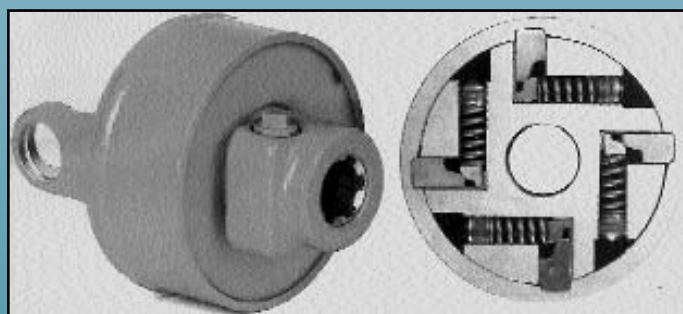



Mid-Size Rectangular Baler Capable of Both Dry Crop or Silage Crop

The Hesston 4755 and Case 8575 Mid-Size Rectangular Baler produces high quality, dense silage and dry crop bales. Design improvements to the pickup, stuffer, plunger and knotter systems along with the addition of new features such as the bale ejector and roller bale chute enhances capacity, performance and durability. The bale ejector utilizes a unique hay dog control feature that allows the operator to select the amount of hay removed from the bale chamber. This feature, combined with an innovative roller-bale chute with a power lift (operated by the bale ejector), are beneficial to all forage producers. **Hay & Forage Industries**, Hesston, KS USA; 316-327-6216



Variable Rate Planter Drive

The Kinze rate-reducing clutch assembly is an electro/mechanical device designed to allow a farmer to apply variable-rate technology to his or her planting systems. The device allows a planter to operate at a normal preset planter population setting or a second preset lower population setting (up to 50% of the normal planter setting). Point-row clutch operation at either setting is maintained. The rate-reducing clutch and the point row clutch are combined into a single compact assembly and form a high/low transmission that allows the farmer to change population on the go. The device maintains the ground drive design of the planter. The rate reducing clutch mechanism is intended for applications where two seeding populations are adequate. Farming areas that have consistent soil types, or center pivot operations, are an example. **Kinze Manufacturing, Inc.**, Williamsburg, IA USA; 319-668-1300

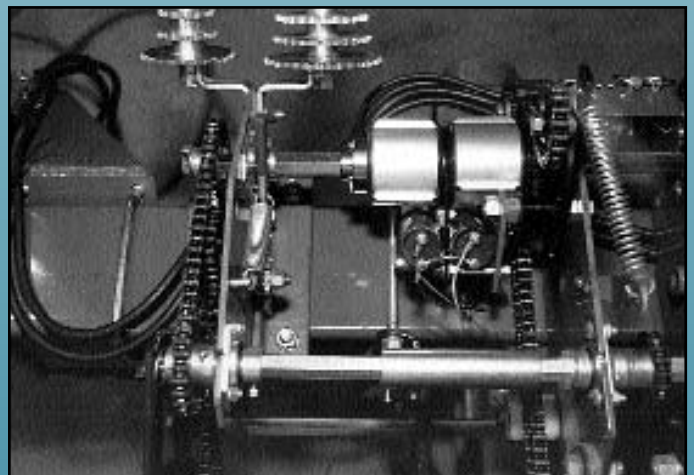



Model 2700 Planter Meets Large Farming Operations' Needs

The Kinze Model 2700 planter is designed as a front-folding, center-flex design planter available in row spacings of 20 inches. It features front-mounted drive gauge wheels that allow for true 20-in. row spacings over the entire width of the toolbar. Additionally, it features a unique folding mechanism that allows a narrow 14'6" transport width. Available in 24-row and 36-row 20 in. configurations, the planter is designed to meet the needs of large farming operations choosing to take advantage of the yield gains possible by switching to narrow row corn and soybeans. Transportability is enhanced on the larger model by a unique sliding axle mechanism that moves the transport wheels forward as the planter folds to reduce hitch weight and provide for a shorter turning radius. **Kinze Manufacturing, Inc.**, Williamsburg, IA USA; 319-668-1300

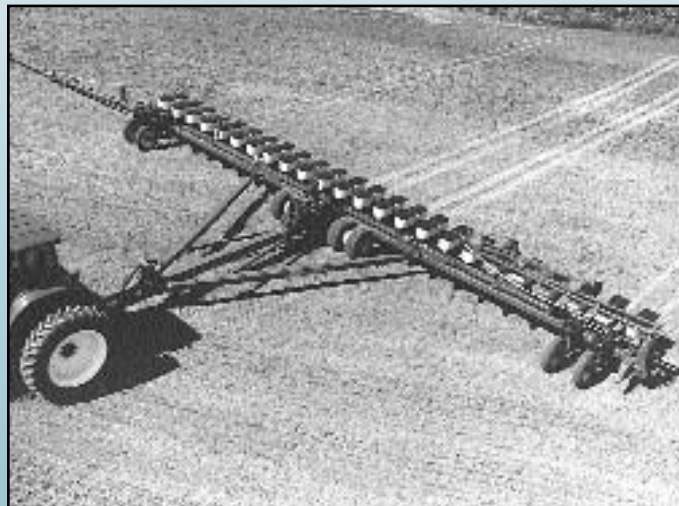

Kinze Introduces Stack-Folding Planter

The Kinze Model 2100 stack-folding planter combines several unique features not normally found on mounted planters. Seed meters are driven through transmissions incorporated directly into gauge wheel/contact tire assemblies on the planter wings, and telescoping U-joints between the wings and center frame eliminate the need for couplers. A hydraulically actuated mechanical latch automatically locks wing and folding link members together, allowing the wings to float up and down over varying terrain. The planter is available in eight- and twelve-row wide or twelve- and sixteen-row narrow configurations. Options available for all models include row markers, electronic seed monitor, a two-to-one drive reduction package, point row clutch, wing downflex package, center section gauge wheels and lift assist wheels. **Kinze Manufacturing, Inc.**, Williamsburg, IA USA; 319-668-1300





Korvan Introduces New “Dried on the Vine” Raisin Harvester

The Korvan 2000 DOV Raisin Harvester is designed to harvest “dried on the vine” (DOV) raisins. This new method of drying (developed by the raisin industry) gives growers, for the first time in history, a practical way to mechanically harvest raisins. The Korvan 2000 removes raisin bunches, separates the fruit from dried vines and debris, and loads directly into storage bins via an over-the-row conveyor. Korvan’s patented Vertirotor™ picking head is angled for optimum pick in DOV trellis systems, thoroughly removing raisins in one pass. The entire picking head flips over to allow picking in both directions. A large, seven-foot drape belt under the picking head allows high picking speeds, gentle raisin handling, cane alignment, and low catcher placement. The unique three-wheel “tricycle design” provides excellent traction. The Korvan 2000 combines high structural integrity with minimum weight, a low center of gravity for stability, and low ground compaction. **Korvan Industries, Inc.**, Lynden, WA USA; 360-354-1500



FROSTCOATS™ The Coated Feed

FROSTCOATS™ is a new, innovative concept in baby pig nutrition from MoorMan’s, Inc. In FROSTCOATS®, heat-sensitive ingredients are coated on the outside of a base pellet. The low-heat coating process preserves the nutritional value of these ingredients while maintaining the advantages of feeding a pelleted product to baby pigs. The result is a highly palatable product that yields superior animal performance. FROSTCOATS™ is particularly well suited for use in segregated early wean swine production systems, as well as being the ideal first feed for pigs weaned at any age less than five-to-six weeks. **Moorman’s, Inc.**, Quincy, IL USA; 217-222-7100, ext. 2441

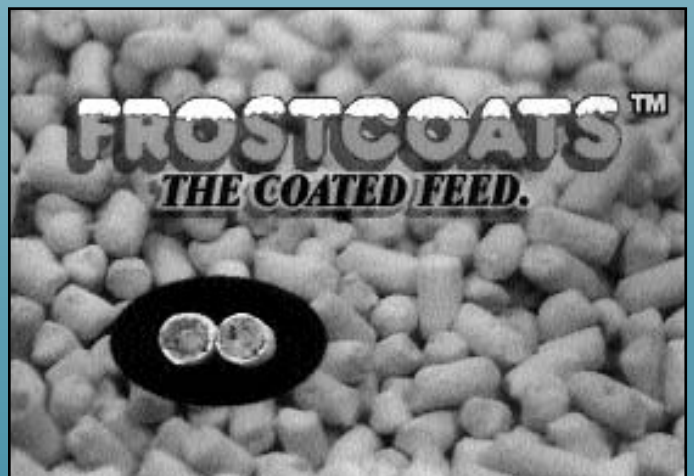



Modular Pivot Sprinkler

The 3000 Series Pivot Products line has been designed for the diverse agronomic needs of center pivot and linear/lateral irrigation systems. Featuring a modular design of interchangeable components, the 3000 Series can meet a wide spectrum of pivot irrigation needs by its adaptability within varying performance characteristics. Simple in-field changes are done with no tools. This optimization within different operating parameters allows proper management of the pivot irrigation system, providing higher uniformity, water and energy conservation, and reduced runoff and leaching of water and chemicals. The 3000 Series features a supplementary computer software program, which assists in the sprinkler selection process for the specific application. Using the flexibility of the 3000 Series Pivot Products, the progressive farmer can now maximize production, while minimizing the inputs of water, fertilizer, energy and labor. **Nelson Irrigation Corporation**, Walla Walla, WA USA; 509-525-7660

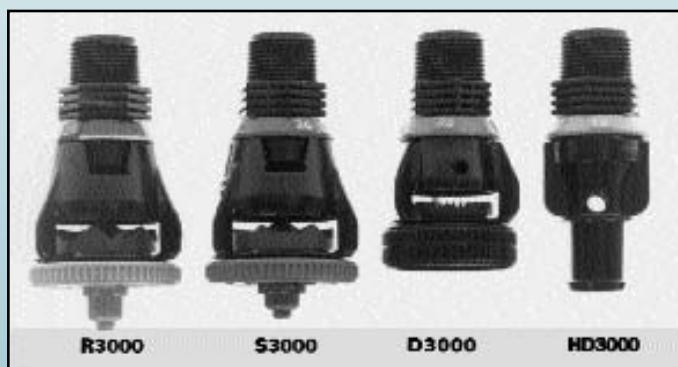

New Holland Self-Propelled Forage Harvesters

The new "FX" range of New Holland Self-Propelled Forage Harvesters is a totally redesigned product, which focuses on increased capacity, serviceability, accessibility, reliability and operator comfort. Serviceability and accessibility have been addressed by designs that make it possible to split functional parts of the units within minutes to allow full access for maintenance and convenient inspection. Reliability has been addressed by sturdy gearbox and shaft drives on all components, which are designed in a highly modular concept. Every function is controlled by microprocessor technology where all internal communication is done by using the CAN protocol for maximum reliability. All communication between the comfortable Discovery™ Cab and central processing unit is done by two fiber-optic cables which ensure a trouble-free data transport. The system contains full self-diagnostics and performs complicated tasks as required for optimized and safe machine operation combined with maximum operator comfort. **New Holland North America, Inc.**, Box 1895, New Holland, PA USA; 717-355-1121





New Holland 35 Series Tractors

The New Holland 35 Series Tractors are an all-new design "world tractor" line with four models ranging from 56- to 86-PTO hp. These all-around utility tractors are designed to perform a variety of tasks on the farmstead with rugged dependability and comfort and convenience. Features include a platform and cab with outstanding driver visibility, excellent entry/exit capability and easy-access controls. The cab is noted for its state-of-the-art climate and noise control, cab space and wide doors. The powerful mid-size engines have a wide working band of useful rpm, and Models four835 and 5635 have best-in-class lift capacity. A patented touch control fast raise/work system maintains pre-set settings for the operator, and operators benefit from the electro-hydraulically controlled front axle differential lock, standard on all FWD models. **New Holland North America, Inc.**, Box 1895, New Holland, PA USA; 717-355-1121



New Holland Metalert[®] Metal Detection System

The Metalert[®] III electronic metal detector system brings significant benefits to operators of New Holland forage harvesters by reducing equipment damage from ingested metal and helping to protect livestock from hardware disease while greatly reducing false detections and unneeded detector replacements. The performance of this improved system is enhanced by using advanced digital signal processing. Susceptibility to a changing magnetic environment is reduced by using proprietary algorithms, which allow the Metalert III to adapt quickly and appropriately to harvester noise levels. The system is also well protected against both electro-magnetic and radio frequency interference. The Metalert[®] III system used on New Holland pull-type forage harvesters interfaces directly to the New Holland Portable Diagnostics Tool (PDT), providing a familiar interface for dealers and simplifying diagnostics by using the interactive, menu-driven four-line by 20-character liquid crystal display. **New Holland North America, Inc.**, Box 1895, New Holland, PA USA; 717-355-1121





New Holland GEMINI™ 60 Series Tractors

The New Holland GEMINI™ 60 Series tractors are an all-new range of mid-size tractors, available in four models ranging from 90 PTO hp to 130 PTO hp. GEMINI™ tractors are designed from the ground up to provide more flexibility in the field and more productivity on the farm, around the world. Key features include the option of the Range Command™ transmission with touch control buttons on a single shift lever for optimum gear selection flexibility; Dynamic Ride Control™ for smooth, safe transport of three-point-hitch mounted implements; front axle differential lock and the TerraLock™ electronic traction control system for improved traction and productivity. These features are controlled from a state-of-the-art cab with excellent room, visibility and all-around operator comfort and convenience. **New Holland North America, Inc.**, Box 1895, New Holland, PA USA; 717-355-1121



New Holland Bale Command Plus™ Operating System

The Bale Command Plus™ operating system, available on Models 6fourfour, 65four and 66four of New Holland Roll-Belt™ Round Balers, makes it easy for operators to make consistent, well-shaped bales; operate the New Holland Bale-Slice™ option; and wrap bales precisely in a choice of patterns, all from the comfort of the cab. The operator's panel, using a large, easy-to-read custom liquid crystal display, offers full, friendly control of various customizable options. Large vertical bar graphs provide dynamic visual information analogous to bale shape that direct the operator to steer left or right to build consistently even-shaped bales that are more resistant to spoilage. Improved itemized options/setup software in Bale Command Plus™ provides more straightforward sensor calibration and diagnostics than previously available. From the tractor, the operator has a full-bale alarm, tailgate latch indicator and bale counter for daily and total bale counts. Easy-to-use software enables sensor and wiring problem diagnosis. **New Holland North America, Inc.**, Box 1895, New Holland, PA USA; 717-355-1121





New Holland Bale Shape System

The **Bale Shape System** provides significant enhancements to New Holland North America's Roll-Belt™ Round Balers by constantly monitoring and reporting the density of both ends of the round bale being formed. For the electronic version of the system, vertical bar graphs on the operator control panel provide dynamic visual information analogous to bale shape. For the mechanical system, pointers on the front of the baler supply the same information. These graphs and pointers instruct an operator to steer left or right to build consistently even-shaped bales. The end results are dense, square shouldered bales that withstand the weather and fewer belt tracking problems within the baler. **New Holland North America, Inc.**, Box 1895, New Holland, PA USA; 717-355-1121

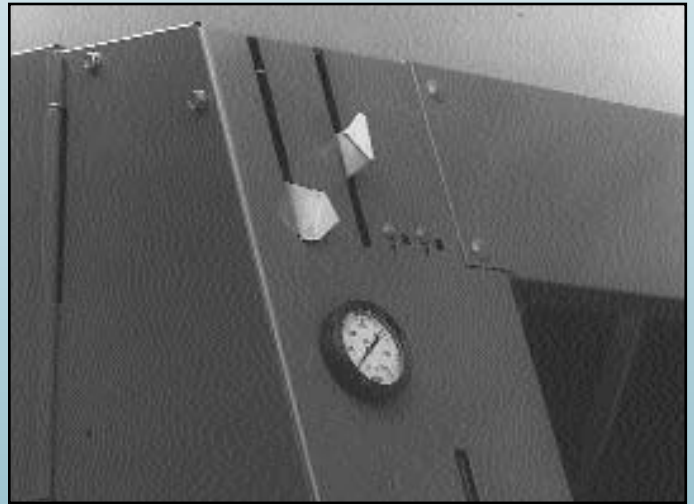

New Holland Disc Mowers

New **Holland Disc Mowers** are designed to travel as fast as ground conditions will allow with their new five-, six- and seven-disc modular cutterbars. They operate in the toughest conditions with non-stop, trouble-free cutting for a clean, even cut in less time. This is made possible by use of the exclusive New Holland Modular Disc Cutterbar. This cutterbar consists of independent, sealed drive modules that contain hardened, precision-forged gears that operate in their own oil reservoir — a design that prevents catastrophic failure of the whole cutterbar if a module is damaged by an obstruction. In addition to the advanced cutterbar design, the Disc Mowers feature a "T-seal" thrust washer (patent applied for) and lip seal at the two cutterbar pivot joints to prevent sand and dirt from entering the pivot bushing, and a fourHB banded v-belt that is spring-loaded to compensate for v-belt stretch and wear. **New Holland North America, Inc.**, Box 1895, New Holland, PA USA; 717-355-1121





Fully-Automatic, Passive Ventilation Inlets Improve the Interior Environment of

Auto-MAX® Ceiling and Wall Inlets are the first fully automatic, passive ventilation inlets for livestock confinement buildings. Designed to admit fresh air into confinement buildings, inlets improve a building's interior environment, enhancing productivity and health of the confined animals and their human caretakers. Auto-MAX® inlets automatically respond to a building's exhaust fans, opening or closing to admit and distribute an optimal air flow to meet interior environmental requirements, independent of weather or seasonal changes. Auto-MAX® inlets are factory calibrated, never needing adjustments typical of other designs. The Auto-MAX® design is made possible by Osborne's development of a general airflow theory for air inlets and the solution of key air inlet design equations. Patents have been filed for the Auto MAX® design. Auto-MAX® inlets are constructed of durable, corrosion-resistant materials which combine the structural strength and thermal properties required in confinement buildings.

Auto-MAX® inlets are the first truly passive ventilation inlet.
Osborne Industries, Inc., Osborne, KS USA; 913-346-2192

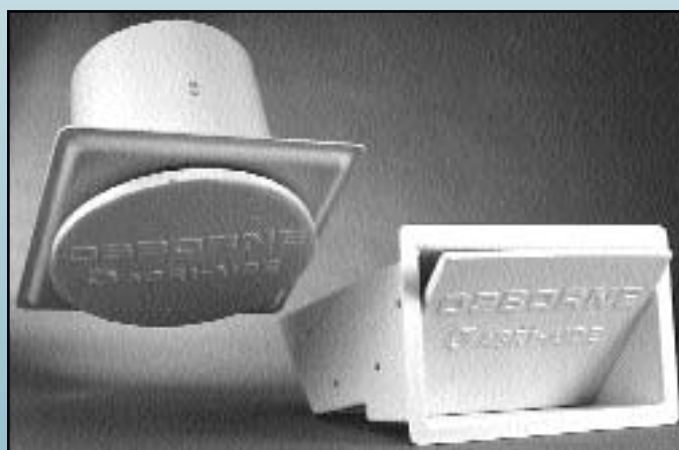

Sauer-Sundstrand Series 45 Open Circuit Pump

The Sauer-Sundstrand Series 45 variable pump is a family of new axial piston pumps for medium power open circuit applications in the agriculture and construction markets. The first displacement introduced is the 57CC. Utilizing QFD and DFM in the development of the Series 45 pump has resulted in a unique new design which meets the performance requirements for medium power applications while making dramatic improvements in pump size, number of components, and modularity. A variety of controls are available to regulate pump displacement in response to pressure, flow, or torque. **Sauer-Sundstrand Co.**, Ames, IA USA; 515-239-6577





Sauer-Sundstrand Integrated Hydrostatic Transaxle

The Sauer-Sundstrand IHT-M15 will help vehicle design engineers reduce product development time by providing a fully integrated product that provides total control of vehicle drive power and vehicle work function power. The vehicle drive system is comprised of a hydrostatic transmission driving a two-speed final drive transaxle. The work function power (PTO) drive incorporates a multi-disc wet electromagnetic clutch/brake for smooth starting and stopping of PTO-driven components. Options include mechanical or hydraulic/mechanical disc caliper brakes and shaft for driving an auxiliary axle. **Sauer-Sundstrand**, Ames, IA USA; 515-239-6000

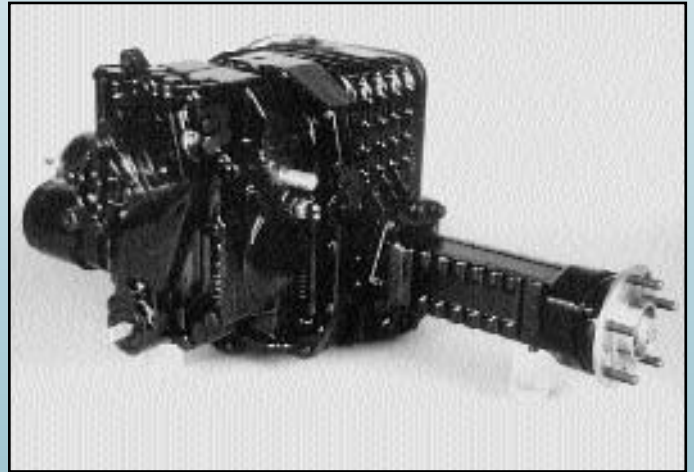

Shear Guard™ PLUS, A Spray Nozzle for Enhanced Efficacy and Drift Management

Shear Guard™ PLUS – A new air delivery nozzle design for agricultural field sprayers has been developed by Spray-Air in collaboration with the National Research Council of Canada. The Shear Guard™ PLUS atomizing nozzle with Dial-A-Drop™ technology allows the applicator to precisely dial in droplet sizes instantly on the go. Since environmental conditions and drift potentials change throughout the day and often while spraying, applicators can now adjust droplet micron size and droplet acceleration velocity during application. This will increase drift management capabilities. Droplet size analysis, liquid flux and droplet velocities measured by Phase Doppler Anemometry show a very uniform droplet size and liquid distribution compared to other nozzles. With crop protection chemistry companies moving toward labeling product use by droplet size, Dial-A-Drop™ technology allows applicators to easily dial in the required droplet size from 100 to 500 microns to fit the chemistry being used. **Spray-Air**, Grangeville, ID USA; 208-983-2002

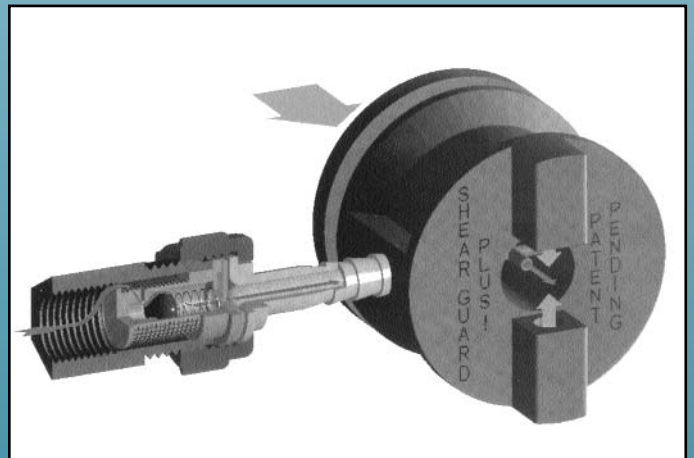



TeeJet® 844 Electronic Sprayer Control

The TeeJet® 844 electronic sprayer control is designed for simple programming and operation. A single, easy-to-read display on the 844 shows application rate, speed, pressure, area covered and volume applied all at the same time. The controller is also designed to maintain the set application rate, with moderate changes in ground speed. Depending on operator performance, the 844 controller may be configured using either a pressure-based system or a flow-based system. It is also available in a three-boom switch version or a five-boom switch version. All aspects of the controller and the 844 kit are designed for easy installation and operation. Simply set your target application rate and the unique VisiFlo® display on the 844 helps you select the right color TeeJet tip to use for your application. The 844 is available and packaged as a complete kit. The kits include sensors, regulating valve, cables and connectors as well as operation manuals. **Spraying Systems Co. – Agricultural Division**, Wheaton, IL USA; 708-665-5000



Accusprayer for Better Coverage of Dense Canopies

The Accusprayer system is based on specially designed air outlets producing turbulent and vibrating air jets. The chemical droplets are injected into the air jets, conveyed into dense canopies, and settle on both sides of the rotating and vibrating leaves everywhere inside. The air outlets are mounted in constant close distance from the canopy. For dense row crops like cotton, the outlets are mounted out of rigid vertical ducts; for field crops they are mounted out of flexible air bags enveloping the rows; for vineyards they are mounted out of flexible air bags; and for orchards they are shaped out of flexible air bags automatically adjusting to the shape of the trees. **Spraytech, Ltd.**, Haifa, Israel; 972 4 832 6618

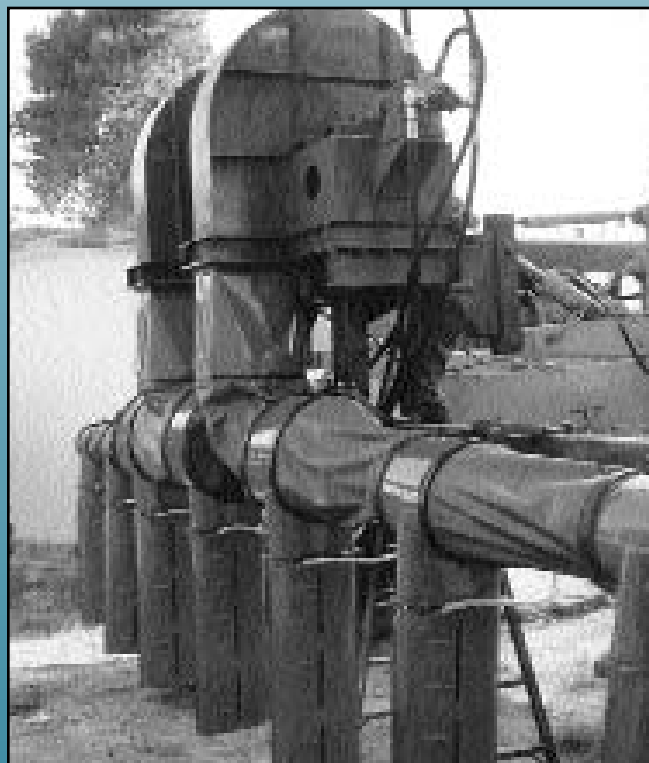



Gooseneck Sprayer

The **Gooseneck Sprayer** is designed to be the ultimate pickup sprayer. It utilizes the field-tested 550-gallon T-Tank sprayer frame, coupled with a Gooseneck hitch. The self-contained unit allows most Top Air booms to be mounted on the sprayer, even hydraulic folds. Weight distribution far exceeds current pickup sprayers, carrying the weight on three axles versus the standard two. This enhances floatation and maneuverability, while greatly reducing compaction. The power unit is mounted high on the unit, reducing contamination from the sprayer operation. In addition, everything can be controlled from the cab. The major benefit of the Gooseneck Sprayer is its flexibility. No longer is it necessary to dedicate a truck solely to your pickup sprayer. A few minutes and the sprayer is unhitched, and your truck is free for other uses. **Top Air Manufacturing, Inc.**, Parkersburg, IA USA; 800-553-3307

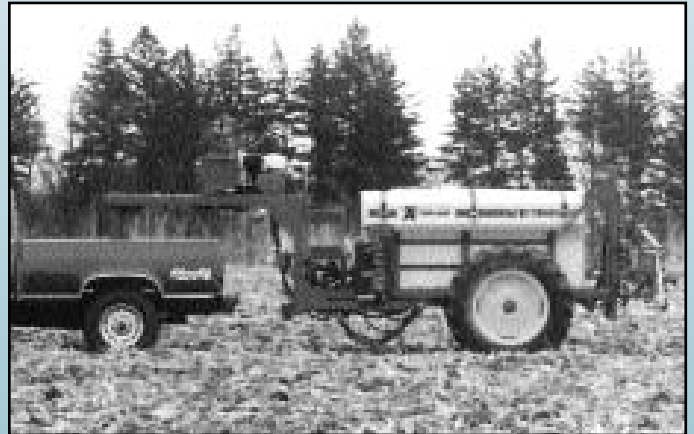

Liquid Manure Floating Injector Assembly

Liquid Manure Floating Injector Assembly is a unique system that allows the operator to inject liquid manure without disturbing crop residue in no-till or reduced-till operations. This injector assembly utilizes a disk coultter ahead of the injection point to slice through existing crop residue rather than pushing it aside. Manure injection is accomplished with operator's choice of chisels or sweeps, after which large diameter, deep throat, finger wheels "feather" residue over slices. The injector is available in three-, four-, five-, or six-shank assemblies with a distribution box that helps to meter liquid output. The shanks are available in either rigid or spring-mount applications, and the tool bar can be mounted to a variety of Top Air/Better-Bilt Slurry manure tanks. **Top Air Manufacturing, Inc.**, Parkersburg, IA USA; 800-553-3307





Revolutionary, Power-Splitting Variable

The continuously variable Fendt-Vario-transmission with power-splitting and high efficiency is a revolution in transmission construction. As the leading German tractor manufacturer, Fendt introduces the continuously variable transmission to the world market, experts are calling it "power-splitting transmission." By power-splitting, the engine output is variably distributed via a planetary drive to the hydrostatic and mechanical drive components, and subsequently reunited on a summary shaft with direct connection to the rear axle. The newly developed adjustable hydraulic pumps and adjustable motors, developed in common by Fendt and another expert company, show obviously better results for durability, performance and power in the tests. The new transmission is operated by a joy-stick, which is built, ready to hand, into the arm-rest of the driver's seat, electronically connected by a servomotor to the transmission. The programme-controlled forward/reverse change, the cruise control "tempomat" and the automatic maximum output control for a best possible machine efficiency are components of the intelligent driving system. **Xavier Fendt GmbH & Company**, Marktoberdorf, Bavaria, Germany; 011 8342-77465



WARRIOR Insecticide Ear Tags Improve Pesticide Efficiency and Cattle Weight Gains

WARRIOR is a 40% organophosphate ear tag which releases a synergized formulation of diazinon and chlorpyrifos over a five-month period from a Tri-Polymer matrix of nontoxic inert ingredients. WARRIOR combines the high fly-killing action of diazinon with the superior lice and tick control of chlorpyrifos. This patented formulation exhibits greater potency than either insecticide used alone and is especially effective against pyrethroid-resistant pests. WARRIOR's concentrated formulation reduces total pesticide costs and improves weight gain by controlling horn flies, biting lice, sucking lice, Gulf Coast ticks, and spinose ear ticks, and aiding in control of face flies, stable flies and house flies. WARRIOR controls horn flies and lice with one tag per head, including lice in winter, and it controls other pests with two tags per head. It has guaranteed retention on the animal and requires no withdrawal time. **Y-TEX Corporation**, Cody, WY USA; 307-587-5515

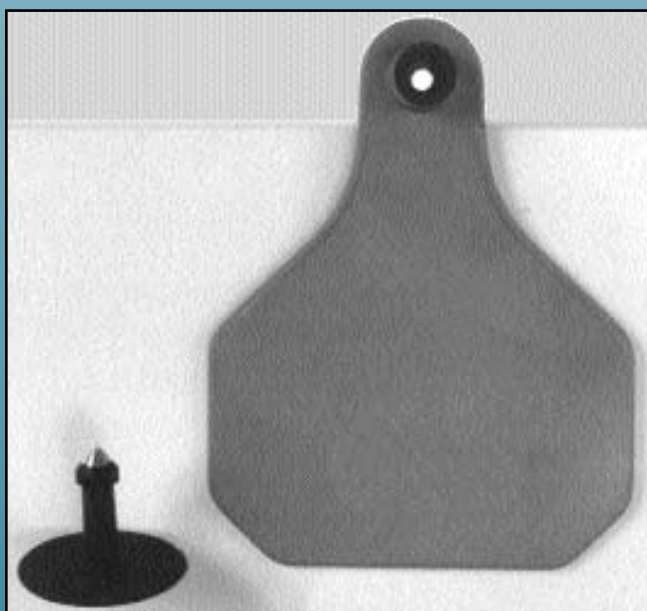



Ag-Chem Equipment Company, Inc.
RoGator® 854 with All-Wheel Steering
Page AE 50/4

***Ag-Chem Equipment Company, Inc./Lockheed Martin™**
AgNav Global Positioning System
Page AE 50/4

Ag-Chem Equipment Company, Inc.
Gator-Stop Valve
Page AE 50/5

Ag-Chem Equipment Company, Inc.
TALON™ (Total Application Logistics Operating System)
Page AE 50/5

Ag-Chem Equipment Company, Inc.
RoGator® 544
Page AE 50/6

AGCO Corporation
White Model 6800 Series Central Fill Planter
Page AE 50/6

AGCO Corporation
Massey Ferguson 6100 and 8100 Series Tractors
Page AE 50/7

Amadas Industries
9665 SP Peanut Combine
Page AE 50/7

Automata, Inc.
MINI-RF Station
Page AE 50/8

B.E.I., Inc.
V45 Mechanical Blueberry Harvester
Page AE 50/8

Bou-Matic
Perfection Milk Meter
Page AE 50/9

Case Corporation
Case 5500 IH Soybean Special
Page AE 50/9

Cornell Pump Manufacturing
4HC Cycloseal™ Irrigation Pump
Page AE 50/10

Deere & Co., Seeding Group
Greenstar™ Yield Mapping System
Page AE 50/10

John Deere Harvester
1850 No-Till Air Drill
Page AE 50/11

John Deere Precision Farming
Positive Driver Rubber Track Propulsion System
Page AE 50/11

John Deere Seeding Group
1780 Planter
Page AE 50/12

Detroit Radiant Products
ReVerber-Ray HL Series Two Stage Infra Red Heater
Page AE 50/12

DICKEY-john Corporation
Precision Control System
Page AE 50/13

Easton Goers, Inc.
Space Cadet
Page AE 50/13

Flexi-Coil Ltd.
Seed Treatment Unit
Page AE 50/14

Finn Corporation
T90 and T120 Series II HydroSeeders®
Page AE 50/14

Gallenberg Equipment, Inc.
Self-Propelled Windrower
Page AE 50/15

Gehl Company
“Total Mix” TMR (Mixer Feeders)
Page AE 50/15

Gehl Company
Total Density Control
Page AE 50/16

GKN Walterscheid, Inc.
K66 Key-Type Cut-Out Clutch
Page AE 50/16

Hay & Forage Industries
Hesston 4755 and Case 8575 Mid-Size Rectangular Baler
Page AE 50/17

Kinze Manufacturing, Inc.
Rate-Reducing Clutch Assembly
Page AE 50/17



Kinze Manufacturing, Inc.
Model 2700 Planter
Page AE 50/18

Kinze Manufacturing, Inc.
**Model 2100 Stack-Folding
Planter**
Page AE 50/18

Korvan Industries, Inc.
2000 DOV Raisin Harvester
Page AE 50/19

Moorman's, Inc.
FROSTCOATS®
Page AE 50/19

Nelson Irrigation Corporation
3000 Series Pivot Products
Page AE 50/20

**New Holland North America,
Inc.**
**"FX" Range of Self-Propelled
Forage Harvesters**
Page AE 50/20

**New Holland North America,
Inc.**
35 Series Tractors
Page AE 50/21

**New Holland North America,
Inc.**
Metalert® III
Page AE 50/21

**New Holland North America,
Inc.**
GEMINI™ 60 Series Tractors
Page AE 50/22

**New Holland North America,
Inc.**
Bale Command Plus™
Page AE 50/22

**New Holland North America,
Inc.**
Bale Shape System
Page AE 50/23

**New Holland North America,
Inc.**
Disc Mowers
Page AE 50/23

Osborne Industries, Inc.
**Auto-MAX® Ceiling and Wall
Inlets**
Page AE 50/24

Sauer-Sundstrand Co.
Series 45 (Variable Pump)
Page AE 50/24

Sauer-Sundstrand Co.
**IHT-M15 (Integrated
Hydrostatic Transaxle)**
Page AE 50/25

Spray-Air
Shear Guard™ PLUS
Page AE 50/25

**Spraying Systems Company,
Agricultural Division**
TeeJet® 844
Page AE 50/26

Spraytech, Ltd.
Accusprayer
Page AE 50/26

Top Air Manufacturing, Inc.
Gooseneck Sprayer
Page AE 50/27

Top Air Manufacturing, Inc.
**Liquid Manure Floating
Injector Assembly**
Page AE 50/27

**Xavier Fendt GmbH &
Company**
Fendt-Vario Transmission
Page AE 50/28

Y-TEX Corporation
WARRIOR Ear Tag
Page AE 50/28

QUALITY PRODUCT. QUALITY PROMOTIONS.

*We can help you
promote your "AE 50" award.*

Resource wants to help you promote your award-winning product to your customers. And we can help you reward the employees who played a part in developing your product. Ask us about the following services:

- ☞ Complete copies of the September issue of *Resource* magazine that contains "The AE 50" section. Ten are provided free of charge. Additional copies are \$3.50 each.
- ☞ Front cover of "The AE 50" section with a description of your winning innovation on the reverse side — 30¢ per copy, minimum order 300.
- ☞ Official, gold-imprinted "AE 50" recognition mug — \$8 each. Sold in sets of four, these make great gifts for employees and are ideal for serving hot drinks to your customers.
- ☞ Beautiful, solid walnut "AE 50" recognition coaster — \$16 each. Each coaster is laser-engraved with the "AE 50" logo. Personalization available upon request.
- ☞ Replica of award plaque presented to the company — \$35 each. Rich, classic walnut for a gift to be cherished. Laser-engraved and personalized.

Resource

2950 Niles Road
St. Joseph, MI 49085-9659 USA
616-428-6337 Fax 616-429-3852



Outstanding Innovations for 1996

Published by
ASAE – The Society for engineering in agricultural, food, and biological systems
2950 Niles Road, St. Joseph, MI 49085-9659 USA
Phone: 616-429-0300 Fax: 616-429-3852 Internet: hq@asae.org