

**AGRICULTURAL
ENGINEERING**

50

***OUTSTANDING
INNOVATIONS
1992***

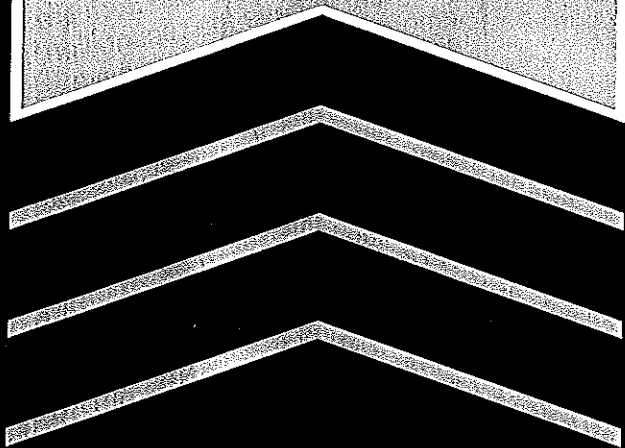

Acknowledging the Best

It is definitely an honor for a new or enhanced agricultural product to find acceptance in the marketplace. For innovative products and systems to be named among the winners of the annual **Agricultural Engineering 50** award is to be held in high esteem by one's peers — designers, developers, managers and others actively involved in the field of agricultural engineering.

Agricultural Engineering is proud to bring into the spotlight the engineering developments in agriculture showcased in this special insert. They hold great promise for helping farmers, processors, researchers and equipment manufacturers to reduce costs, improve quality, enhance nutritional values, become competitive and improve profitability.

Entries were solicited from virtually all companies involved in the development of products and systems that are intended principally for use in the production, processing, research, storage, packing or transportation of agricultural products.

These entries were thoughtfully reviewed by a panel of judges for the purpose of identifying those most likely to make a "worthwhile contribution to the advancement of engineering technology in food and agriculture."

To all those companies that submitted entries, **Agricultural Engineering** sends kudos for their continuing efforts to bring new products and systems to market.

AND — to all the individuals involved in the conception, design and development of the 1992 AE 50 award-winning products and systems — WE SALUTE YOU!



Folding Grain Drills Offers Seeding Accuracy

Case-IH's 5500 Conventional and Minimum-Tillage Folding Drills offer seeding accuracy and depth control for a variety of cropping practices. The Min-Till model features the Min-Till staggered offset double-disk openers for light reduced tillage and hard soil operations. The conventional 5500 has traditional side-by-side double disk openers. Both models have 7 x 7 x 1/4-inch tubular drill frame, and can meter a variety of small grain seeds with the accuracy of smaller conventional drills. Each model is available with 7 inch and 7-1/2-inch open spacings. By blocking every other feed cup or groups of three cups on the 7-1/2 inch model, the 5500 can easily be converted for 15-inch row spacing if desired. Folding to just 13 ft 8 in., the 5500's entire folding and unfolding process can be completed from the tractor seat in seconds. There are no lockout pins to remove or install. Since the drill frame folds forward horizontally to equalize weight on the carrying wheels, there is no need to empty hoppers prior to transport. J I Case, Agricultural Equipment, Hinsdale, Illinois, (708) 789-7145.

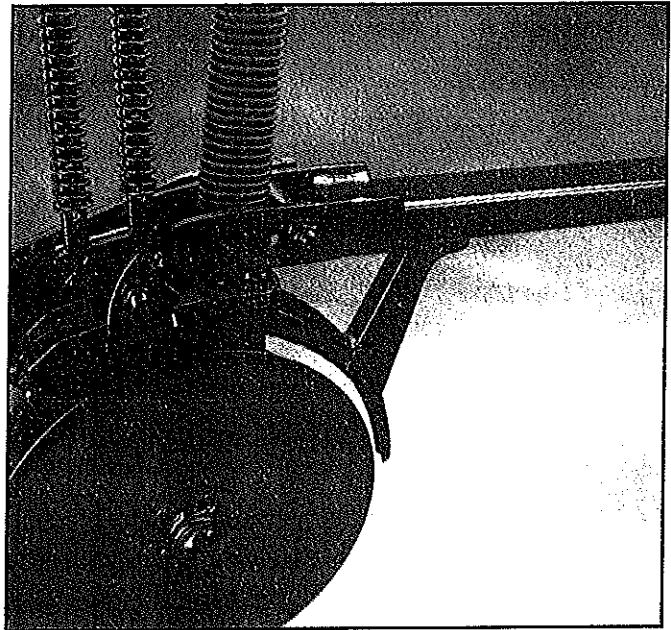

Four-Row Peanut Combine Harvests at Speeds Comparable to Two-Row Peanut Combines

Bush Hog/Lilliston's Model 9004 Four-Row Peanut Combine is a PTO powered, pull-type implement that lifts inverted peanut vines from the ground and feeds them into a three-cylinder picking system. After picking, the peanuts are separated and cleaned before being pneumatically conveyed to the holding basket. Separation occurs at the concaves and on seven straw walkers. The peanuts are cleaned mechanically and pneumatically as they move across the chaffer and are exposed to uniform air blasts. The Model 9004 was designed and manufactured with the aid of CAD and CNC equipment. Counterbalanced flip-up shielding, low profile - no overhang basket, swing tongue for easier dumping and highway transportation, variable speed pivoting header and high-

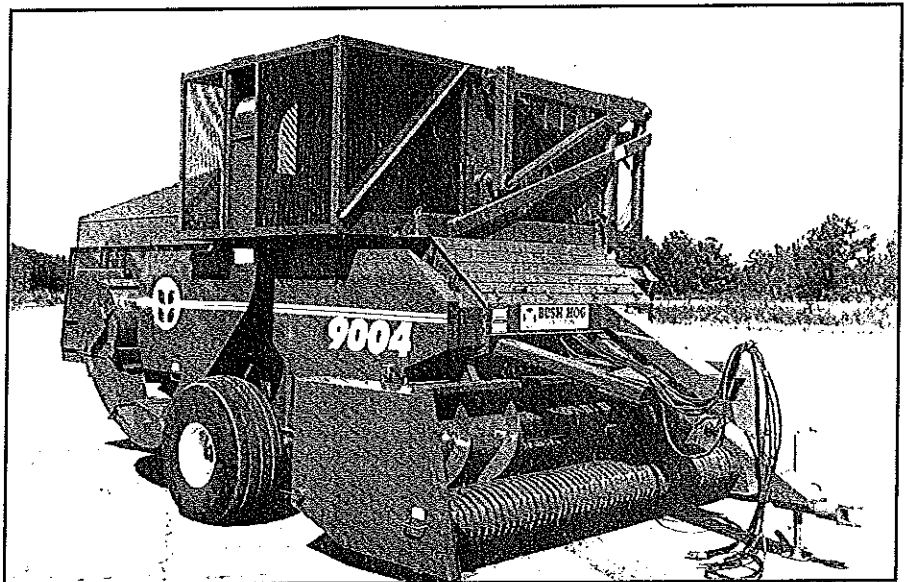

way/work lights are all standard features. Bush Hog®/Lilliston, Selma,

Alabama, (205) 874-3155.

High-Efficiency Direct Drive Fans

Aerotech's Advantage™ Direct Drive Fans feature a vacuum-formed, unibody housing, made of the field proven polymer, Rovel®, which makes the fans completely corrosion resistant while maintaining maximum performance and efficiency. Rovel is a rugged, durable thermoplastic polymer that has shown extreme resistance to corrosive environments, as well as sunlight, heat and cold. An exclusive Shutter-Lock™ design on the 24-inch fan uses counter weights to reduce airflow resistance through the shutters and help lock the shutters shut against air leaks. The all-aluminum shutters are held in place by stainless steel shutter clips, allowing "No Tools Required" servicing. The Advantage fans are available in 16-, 18- and 24-inch sizes. New round-to-round discharge cones on the exhaust boost airflow by 6 to 8 percent. Aerotech, Inc., Lansing, Michigan, (800) 227-AERO or (517) 323-2930.

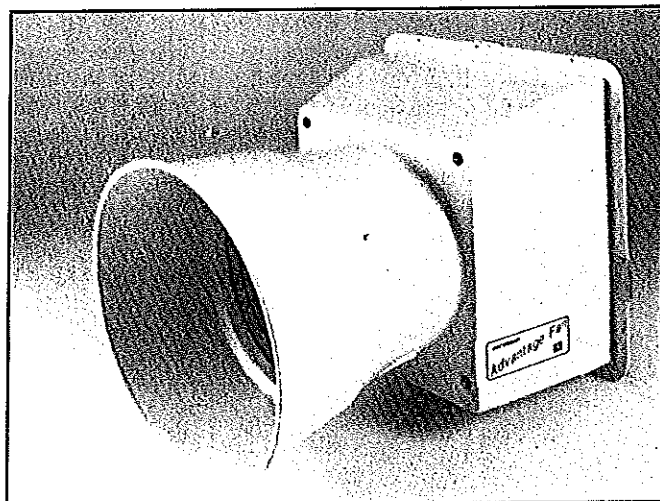

Continuous Flow Dryer Control for Commercial and Farm Applications

Optek's SENSOR™ 6000 Precision Drying Control has monitor and control applications for all continuous flow models to both commercial and farm drying equipment. Four rugged and large area moisture sensors, each with temperature compensation, are placed in the drying column and provide increased accuracy on the conditions of the dryer. This and expanded microprocessor technology result in greater control of the drying process. The improved moisture control, simpler installation and an easier-to-use operator panel are featured in the model. An included printer provides permanent records of the drying season. The SENSOR 6000 technology has been designed to work with several grains, pellets and meals. These are user selectable through the extensive options menu. Documented energy reductions, labor savings and more uniform grain moisture combine to generate a return on investment that is less than two years in most operations. Optek, Inc., Galena, Ohio, (614) 548-4700.

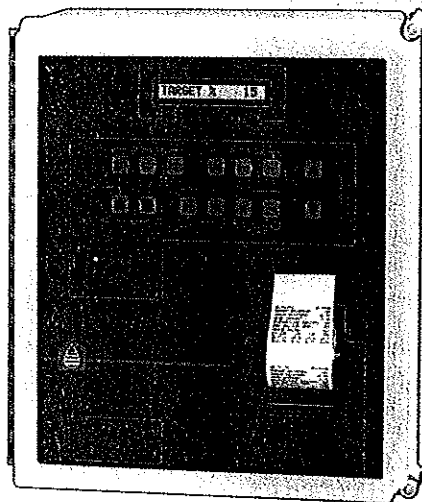

Portable Trommel Used in Recycling Operations

The AMADAS T72X20 Portable Trommel, electrically driven, is a completely self-contained mobile screening device designed to classify materials by size. Intended use for

the recycling industry is to separate composted yard waste or sewage sludge to produce a valuable soil product that can be used by agriculture and homeowners. Topsoil,

bark/wood waste and demolition debris have also been successfully classified. Material to be classified is dumped into a live chain bottom infeed hopper through a very coarse screen to remove large, undesirable chunks. The chain meters the material onto a high-speed belt, which spreads it and propels it into a clod buster in the throat of the Trommel drum. The rotating drum, surrounded by wire mesh screen, tumbles the product, breaking more clods and passes the smaller material out through the screen openings. Overhead return chain conveyors collect and stack the screened material. AMADAS Industries, Suffolk, Virginia, (804) 539-0231.

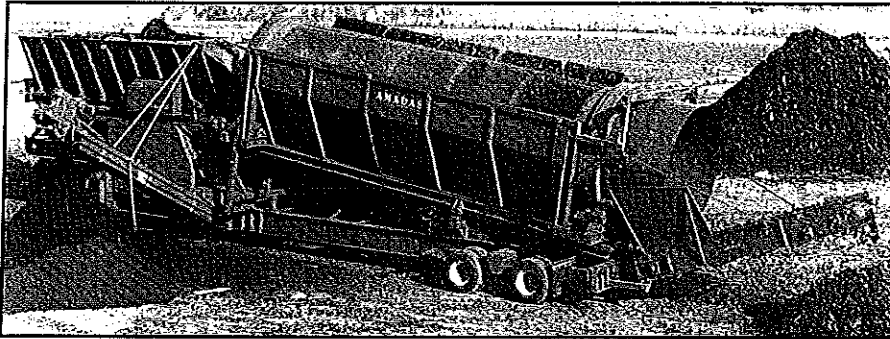

System Applies Granular Herbicides and Dry Fertilizer Simultaneously

Granular Chemical Metering and Distribution System for Tru-Spread® applicator is a system developed in cooperative effort by Gandy Company and Ag Chem Equipment, Inc. The system, developed to apply granular herbicides simultaneously with dry fertilizer,

uses radar and a computer to control the rate of chemical applied between 2 and 26 lb per acre at speeds up to 20 mph. Gandy Company adapted its Orbit Air® chemical metering and pneumatic distribution system to fit the confined spaces on the rear of the Tru-Spread applicator. The blow-

er that supplies air to the pneumatic system is powered by an hydraulic system installed on the chassis for that purpose. Gandy Co., Owatonna, Minnesota, (507) 451-5430, and Ag Chem Equipment, Inc., Minnetonka, Minnesota, (612) 933-9006.

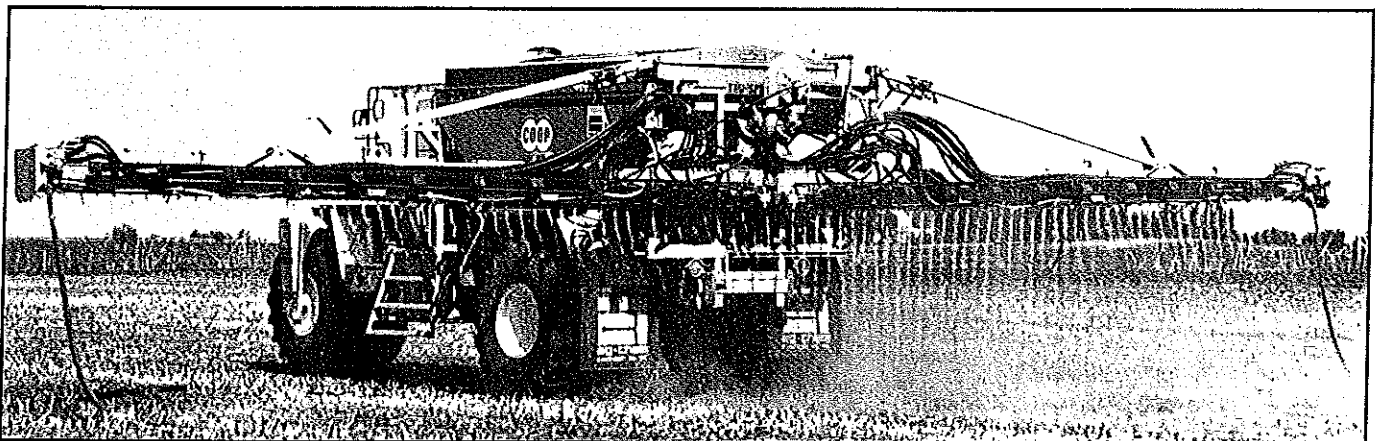

Soil Moisture Measurement System

The Campbell Scientific TDR (Time-Domain Reflectometry) Soil Moisture Measurement System has a CR10 or 21X datalogger that controls multiplexers and a Tektronix 1502B TDR cable tester to provide automated, multiple probe, TDR soil moisture measurements. Features include automated, long-term in situ measurements; outputs of volumetric water content or raw data; and multiplexes up to 512 probes. Power is switched on only during measurements. Campbell Scientific, Inc., Logan, Utah, (801) 753-2342.

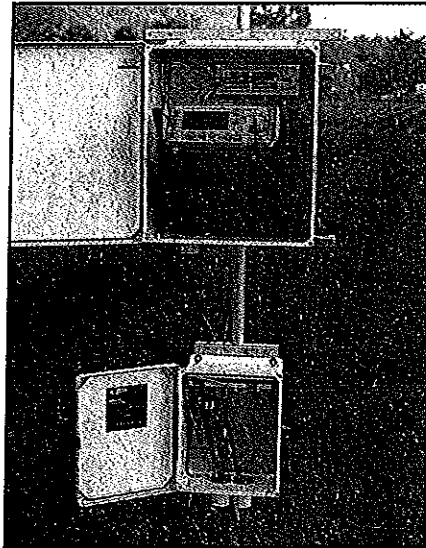

Gleaner Rotary Combines Have ComforTech® Cab

AGCO's Series 2 Rotary "Gleaner" Combines feature a new operator station and "ComforTech" cab for all models. Improvements in the cab include more space for the operator, reduced noise level, improved visibility, better styling, more user friendly controls and monitors, and improved comfort and safety. Other machine improvements include new developments in the rotary threshing and separating areas, a redesigned feed housing to provide visibility and header angle adjustment, reduced number of drives, increased commonality of parts across the product line, and improved safety features. AGCO Engineering Group, Independence, Missouri, (816) 836-6411.

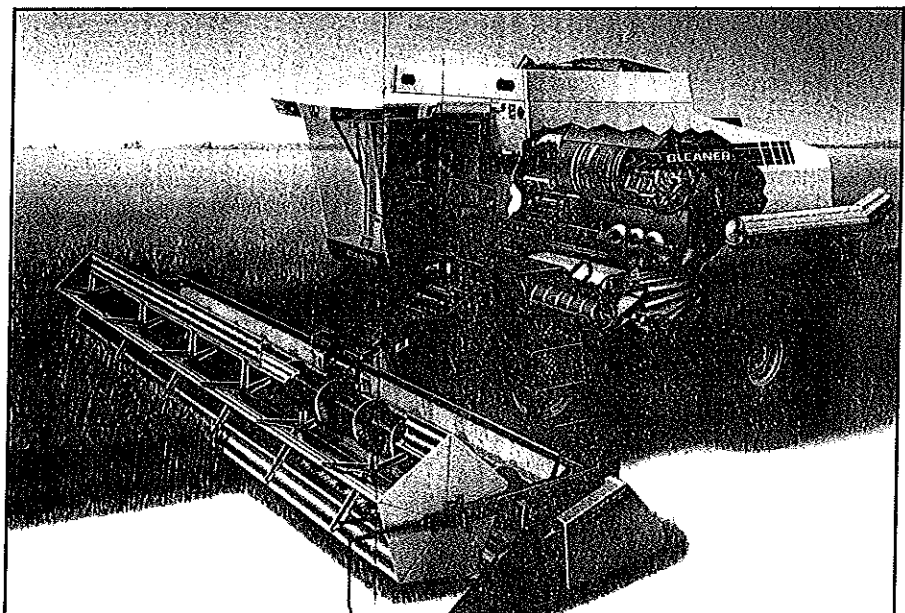

Soil Moisture Measured Via Measurement of Dielectric Constant

Automata's AQUA-TEL measures soil moisture content via measurement of dielectric constant. It provides a highly stable measurement of soil moisture which is averaged over an extended area as opposed to a single point. It is maintenance free and can be permanently planted in the soil, if desired. The output signal is 0-1mA for industry standardization as well as a noise immunity in cases where long wire lengths are needed for remotely reading the sensor. The electronics are environmentally sealed and the aluminum probes are protected by a hard anodized surface. Automata, Inc., Grass Valley, California, (916) 273-0380.

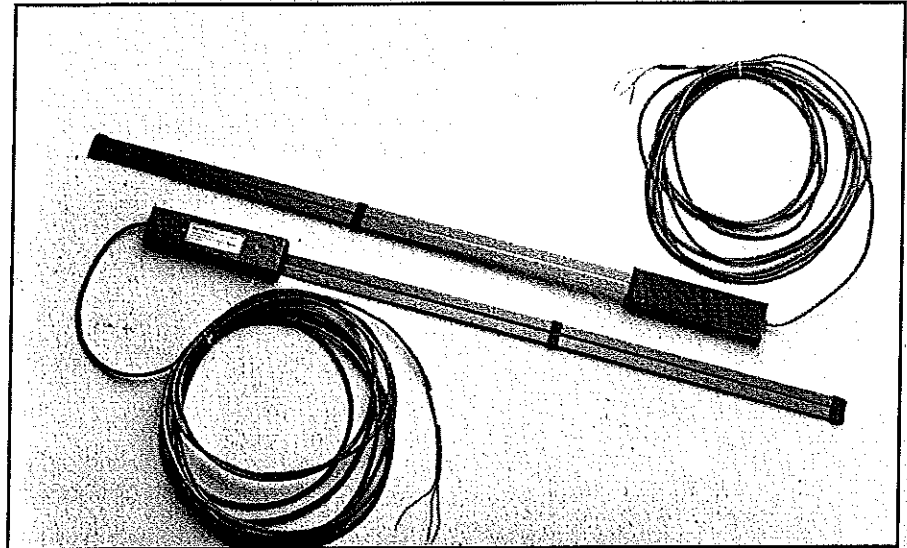

Combo-Mulch Finisher is a Combination Secondary Tillage Tool

Case IH's Model 4200 Combo-Mulch Finisher is a combination secondary tillage tool designed to prepare seed-beds and effectively incorporate chemicals. It consists of a row of disks, four rank field cultivator, and a leveling harrow attachment. Six sizes, two rigid (11 ft 10 in. and 15 ft 1 in.) and four folding (20 ft 8 in., 26 ft 2 in., 30 ft 8 in., 34 ft 1 in.) will serve all farm sizes, especially with maximum 15.4 ft transport width. Features include self-leveling hitch, hydraulically controlled cushion disk gangs, mechanical shank depth control, walking tandem wheels, 6.7 inch-shank spacing, and spacious residue tunnels. The 4200 will positively help comply to the 1990 Farm Bill by saving time, fuel, money and reduce compaction leav-

ing a high percentage of residue on the surface and a level, firm seed-bed behind. Fully raising the disk gangs gives the customer an option of using

the tool as a field cultivator as soil conditions dictate. J I Case, Agricultural Equipment, Hinsdale, Illinois, (708) 887-2110.

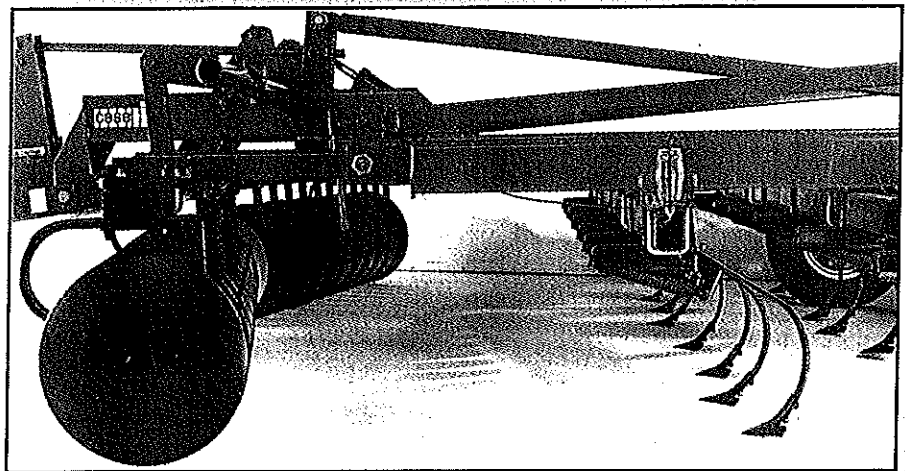

Dual Curtain Control Manages Natural Ventilation

Chore-Time's Dual Curtain Control optimizes ventilation in curtain-sided animal housing. The control's purge function assures adequate fresh air during cold weather; the adaptive curtain movement algorithm prevents unnecessary curtain movement during ideal conditions and rapid response to temperature changes. Override switches provide complete manual control, even if the fuse or electronics are blown in a lightning strike. Individual sensors, temperature setting knobs and purge control switches permit fine tuning the house. The purge function can be disabled for the windward curtain during extreme cold winds, and fresh air can be permitted in the lee side. Indicator lights and settings can be viewed through the clear sealed cover. The control can be used for baffles, doors and other natural ventilation devices. A single curtain version is available. Chore-Time Equipment, Milford, Indiana, (219) 658-4101.

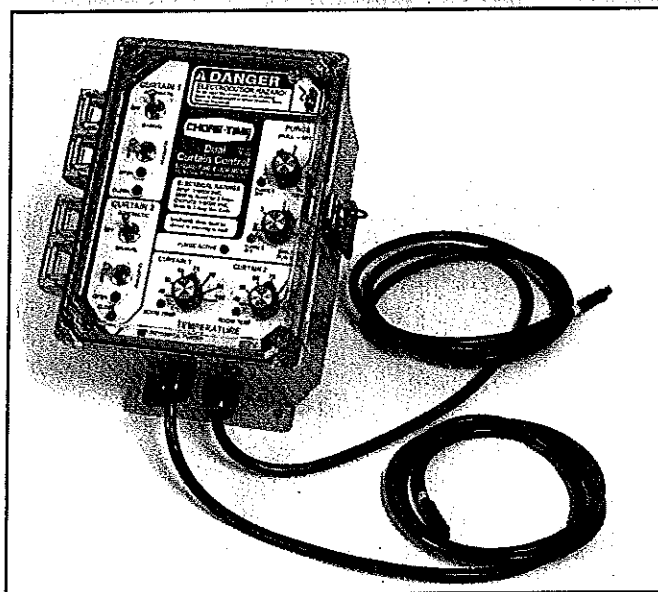

Total Seedbed Preparation in One Operation

Dickey's Incorpovator™ is a three-point hitch, mounted multifunction tillage tool that performs five jobs to save fuel, chemicals, labor, moisture and machinery hours. From front to rear, the Incorpovator knocks the bed down to the desired level, bands and double incorporates the preplant chemicals in the top 1 inch to 1-1/2 inches of the bed and firms and flattens the bed, thereby sealing in valuable moisture and chemicals. As a result, every bed is exactly the same height, the middles are left uniformly deep. By establishing a traffic pattern and by not working the ground so many times, there is less moisture loss, less soil compaction and a more mellow bed. Dickey Machine Works, Pine Bluff, Arkansas, (501) 536-1300.

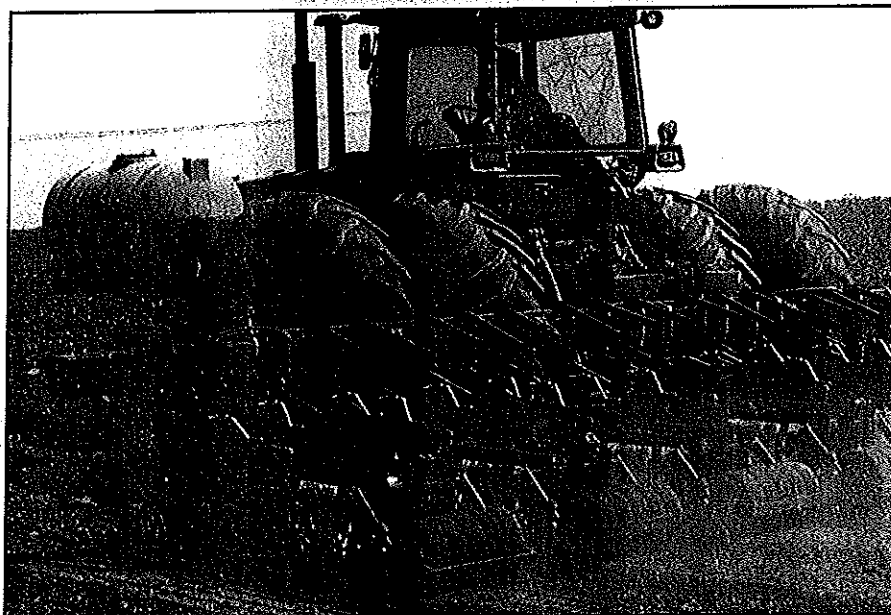

Insulating Sheathing Reduces Radiative Heat Transfer

Celotex's Thermax® Blackcore™ insulation blocks radiant heat flow effectively through a patented manufacturing process that uniformly disperses carbon black throughout the insulation. Designed for modified bitumen, build-up and single-ply roofing applications in commercial, masonry, metal and rural building, the Thermax insulation board is available in a variety of finishes for concealed and exposed applications. Features include a moisture barrier and vapor retarding aluminum foil facers that provide a .02 moisture permeability rating. The Celotex Corp., Tampa, Florida, (818) 873-4230.

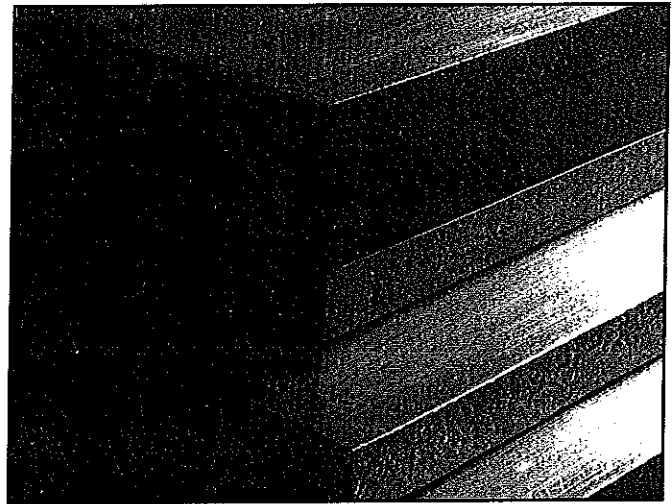

Mechanical Front Drive (MFD) Tractor Has Highest Rated Horsepower

Case IH's 7150 Magnum Tractor is the highest horsepower MFD-type tractor ever produced. It has unprecedented power at 215 PTO horsepower and hitch lift capacity at 14,950 lbs. The 7150 extends the Magnum line of 2WD and MFD tractors to five models. The 7150 was developed for more lift capacity and horsepower for heavy ridge-till, min-till and no-till operations as well as for other heavy tillage applications. Features include a wastegard turbocharged engine with increased capacity fuel injection pump, 2-1/4-inch lift assist cylinders, improved cooling system and a quick hitch coupler. J I Case, Agricultural Tractors, Racine, Wisconsin, (414) 636-0203.



Emergency Ventilation System for Confinement Buildings

Guymon's Guardian is an emergency ventilation system for confinement buildings where pigs are susceptible to suffocation during power outages. The system connects into the water pressure of buildings and monitors all fan circuits. When power to the circuits is disconnected, the Guardian opens either an emergency door or the shutters on the fans in the building. This provides air circulation to the building until

power is restored. The Guardian recharges itself and is ready to handle another power outage. A control panel shows a green light when power to the circuits is operating normally and a red light when a power failure has been experienced. The system will operate if a red light is showing, but the producer must reset the panel to clear the red light. **Guymon Manufacturing Co.**, Salem, Illinois, (800) 562-0164.

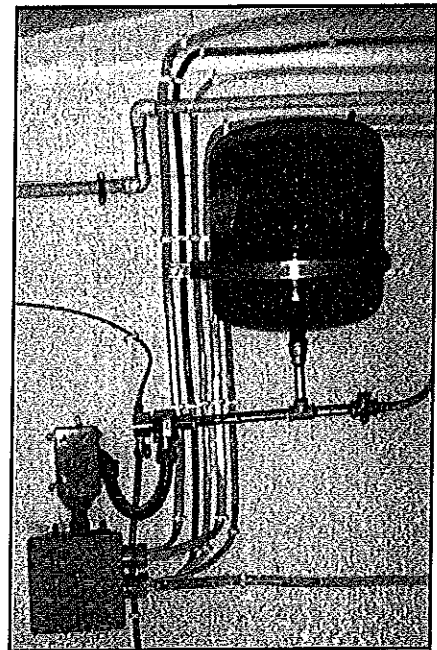

Rice Combine Applies New Concept to Material Flow

John Deere's CTS Rice Combine uses a conventional cylinder for the primary threshing function and for smooth straight-through flow of material during threshing. A tine separating module is employed behind the cylinder to provide a smooth material flow through the machine. The tines in the separating module penetrate the straw mat and pull the material around the housing. The off-center location of the tine impellers provides an area of high clearance at the top of the module, which allows centrifugal force to remove the straw mat from the tines. With the mat released from the tines, the vanes located in the top of the housing move the material rearward in the machine. As the straw comes around the housing and re-enters the lower half, it is re-engaged with the tines and the process is repeated until the material is discharged from the machine. The tine separators are in a self-contained module that is mounted in the machine on a track system. The complete tine separating module can be rolled out the rear of the combine for simple access when servicing is required. **John Deere Harvester Works**, East Moline, Illinois, (309) 765-2107.

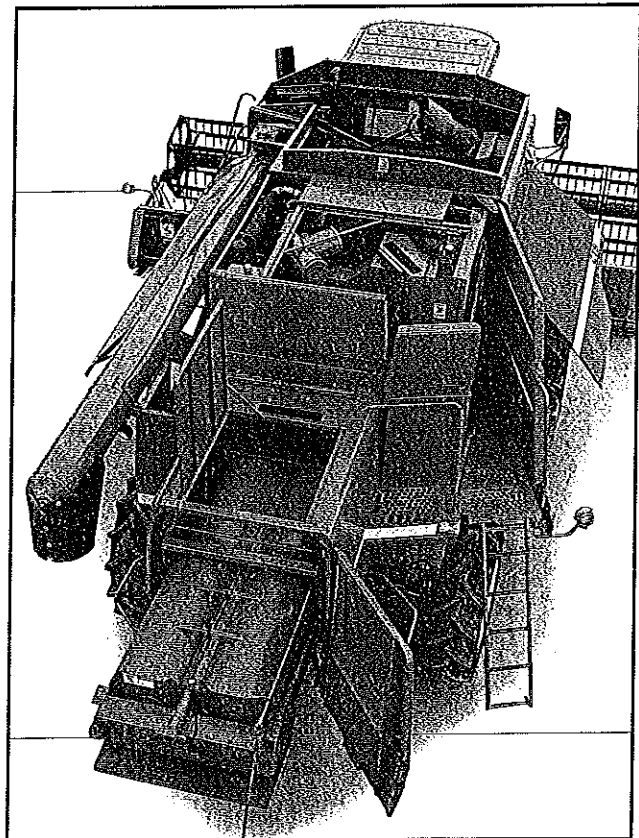

Industrial Skid-Steer Tires Provide Increased Tractive Ability

The Pirelli Armstrong Contractor FWD line of industrial skid-steer tires provides increased tractive ability and protection in the rim flange area through the use of a Trash Shield construction. The construction of the tire, and the materials used, are the same as those in the larger size R-4 tires produced by Pirelli Armstrong. The tread design is an extension of the Armstrong L-2 Loader-Dozer and the R-4 industrial tractor drive tires currently in production. While this class of tire is normally considered to be a "skid-steer" size, Pirelli Armstrong redesigned it to complement their larger R-4 drive tires as the Front Drive on MFD industrial tractors. Pirelli Armstrong Tire Corp., New Haven, Connecticut, (203) 784-2244.



Dual Fuel Engine Utilizes a New Electronic Fuel Management System

John Deere's 6076AFD Dual Fuel Engine is designed to operate an irrigation pump on diesel fuel or a combination of diesel and natural gas. The engine uses the diesel as a pilot injection to start combustion, therefore a spark ignition system is not required. The system consists of a electronically controlled diesel injection system, electronic natural gas governor and actuator and an electronic manager called a Link Controller. Features include natural gas hardware components, operator control panel, interconnecting wire harnesses and a 6076AFD turbocharged and aftercooled engine. The choice of diesel or dual fuel operation is provided via a switch on the operator's panel. The engine can operate on dual fuel between 1400 rpm and 2200 rpm above 40 percent load, and allows the operator to fuel based on fuel prices and availability. The engine will automatically return to diesel operation if the gas pressure goes below a set value. John Deere Engine Group, Product Engineering Center, Waterloo, Iowa, (319) 292-8181.

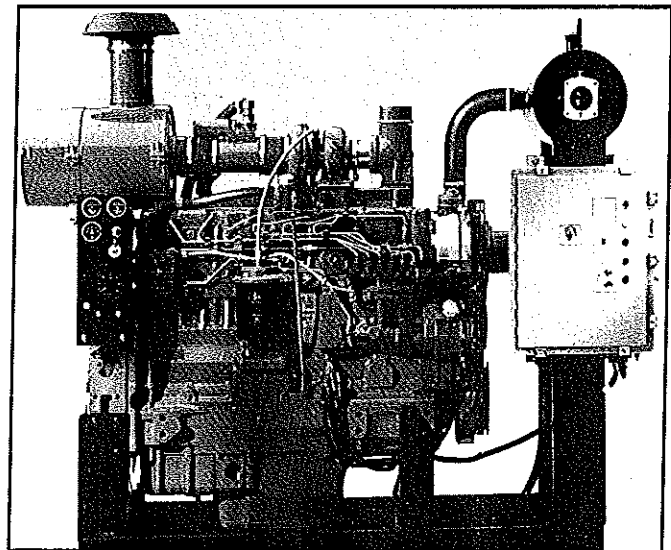

Front Mower Features Four-Wheel Drive System

KUBOTA's FZ2100 has "Zero Diameter Turn (ZDT)" with 20 hp, and an "Auto Assist Differential (AAD)" four-wheel drive system. The ZDT feature enhances overall mowing performance with minimal turf damage in an expansive array of mowing conditions, particularly in confined areas. The AAD four-wheel-drive system automatically provides improved traction for today's demanding mowing conditions. It transfers power to all four wheels on slopes or in soft soil, wherever and whenever additional traction is needed and automatically switches back to two-wheel drive in normal ground conditions. Because the front wheels rotate freely during the zero diameter turn, the operator can turn completely around in one spot without damage to the turf. The FZ2100 has steering provided by a full-tilt power steering wheel rather than a joy-stick with hand levers. KUBOTA Corp., Compton, California, (310) 537-2531.



Computerized Control System for Irrigation

The AQUALOG computerized control system for irrigation, from FINAGRI/EDIL automatically adjusts to varying weather conditions of the field. Using the multiplexing technology to carry both the energy and control command to operate 24 VAC solenoid valves, the system is designed to centrally control hundreds of irrigation solenoid valves on medium to large scale turf, solid set or drip irrigation systems. The single wire concept dramatically reduces the amount of wire to install, simplifying the installation and making extension very easy. The Aqualog is a global water management system that offers ET driven logic of control that reduces water consumption, constant monitoring of field multi-coders that provides high level of reliability, and instant system diagnosis

and a water scheduling program that provide automatic flow smoothing for hydraulic balance and better pump management. The Aqualog offers

1,584 independent stations, 88 independent programs, 2,784 different flow zones. FINAGRI/EDIL Division, Boit, France, (011) 33-9365-62-50.

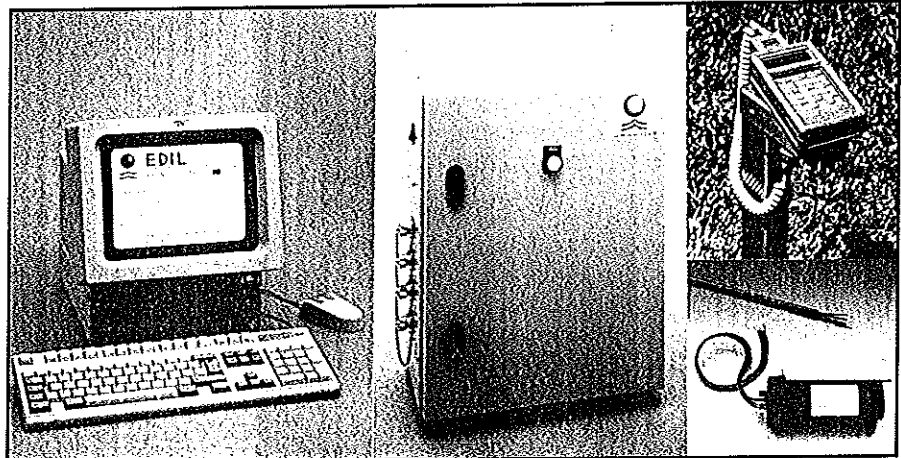

Moisture Meter Designed for Continuous Monitoring

Delmhurst's RDM-H Hay Moisture Meter is designed to be mounted inside the cab of a tractor to enable the operator to constantly monitor the moisture content of the hay as it is being baled. The RDM-H has a sensor that is mounted in the bale chamber, a 30-foot cable that goes from the sensor to the meter and the instrument itself. The model gives average moisture content, highest reading, lowest reading and standard deviation. Depending on the mode chosen by the user, the meter will display all of this information or various combinations of it. The RDM-H is powered by the 12-VDC system of the tractor and can be used with virtually any make/model tractor and baler. Delmhurst Instrument Co., Towaco, New Jersey, (800) 222-0638.

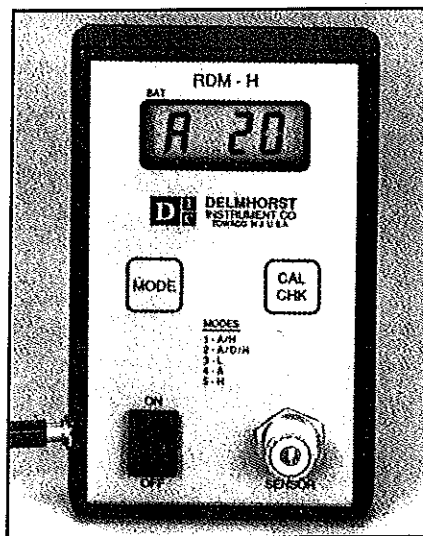

Computerized Steering Control for John Deere Cotton Stripper

The Orthman CSC Harvester Guidance System, developed for the John Deere™ 7445 Cotton Stripper, maximizes field efficiency while decreasing operator fatigue. Once the harvester is aligned with the rows, the CSC Guidance System, activated by the foot control, takes complete control of all steering functions, thus alleviating the operator of the intense task of constantly keeping the harvester aligned. Three safety features automatically disengage the operation of the Guidance System. The pressure switch located in the hydraulic control module ensures the operator immediate manual steering control by simply turning the steering wheel. A second switch disengages the system when the operator seat is left for more than five seconds. The final safety feature makes it impossible for the system to be

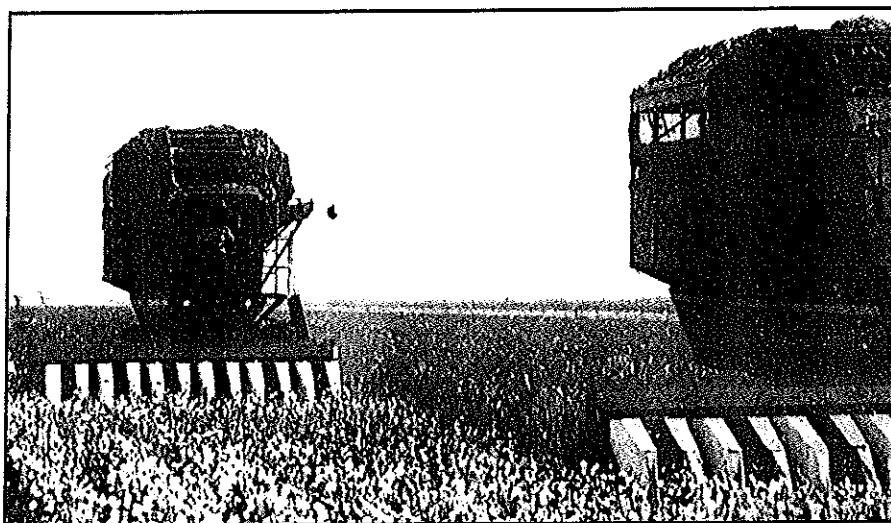

accidentally activated during transport. The controller is programmed to disengage the system at speeds of more than 7.5 mph. Orthman Man-

ufacturing, Inc., Lexington, Nebraska, (308) 324-4654.

Sap Flow Measurement System is Fully Portable

The Dynamax Flow32™ Sap Flow System is designed to be fully portable. The system includes a control unit, software and sensors and is equally suitable for laboratory or field research. Capable of providing accurate information on sap flow in trees, ornamentals and crop plants, Flow32 helps monitor general plant health. It can also be used to monitor the effects of genetically engineered disease resistance, crop growth patterns and fertilizer efficiency. Including a fully integrated software package and microprocessor controller, Flow32 is supplied with a selection of five sensors as standard, although each system can monitor up to 32 plants at a time. Non-intrusive and requiring no calibration, the sensors can be used on stems from 5 mm to 125 mm in diameter. Sap flow results are given as grams/hr or total daily transpiration rate. Included in the system are a dedicated PC software support package for data logging, data analysis and retrieval, and downloading of control programs. Dynamax, Inc., Houston, Texas, (713) 771-4224.

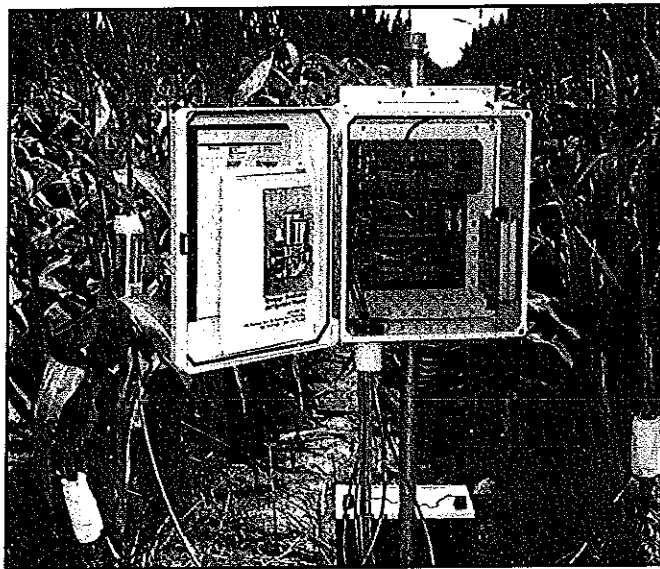

Moldboard Plow Designed for Heavy-Duty Plowing

The J I Case 4 through 7 furrow Model 7500 Moldboard Plow is designed for heavy duty plowing. Main frames, wheel and hitch components are designed to perform with high horsepower 2- and 4-wheel drive tractors. Infinite cutting widths between 14 inches and 22 inches are easily adjusted mechanically or hydraulically. This feature helps control residue and field roughness and match cutting width to tractor size. Automatic optimum line-of-draft is available for best operating performance. Universal clevis-type trip mountings allow all models to be equipped with automatic reset or a new simplified toggle trip. Heat-treated steel forgings are welded into the mainframe to provide a heavy-duty pivot for the trip mountings. Common frames with heavy wall tubes

are used for major frame components. This allows frame expandibility with a universal extension attach-

ment. J I Case, Agricultural Equipment, Hinsdale, Illinois, (708) 887-2110.

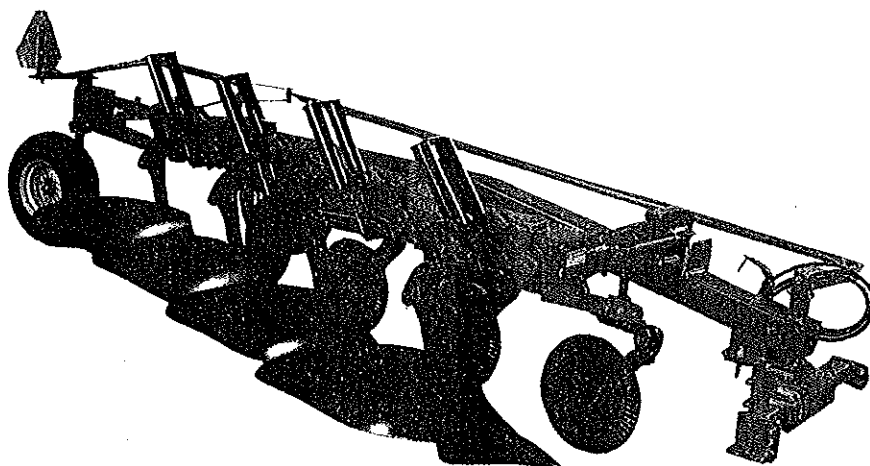

Air Seeder Cart Has 230-Bushel Capacity

The Flexi-Coil 2320 Air Seeder Cart is used with an air drill or air seeding tillage implement to offer accurate and versatile placement of seed fertilizer and granular products in a wide variety of configurations. Product enhancements include air velocity control of the product streams as well as the ability to place seed, fertilizer and herbicides all independently or in combinations. The 2320 has a total capacity of 230 bushels in two tanks for seed and fertilizer as well as an optional integral third tank with a capacity of 30 cubic feet. It is equipped with ground driven meters with an hydraulic driven fan. It can be towed behind the ground opening unit or between the ground opener and the tractor. Flexi-Coil Ltd., Saskatoon, Saskatchewan, Canada, (306) 934-3500.

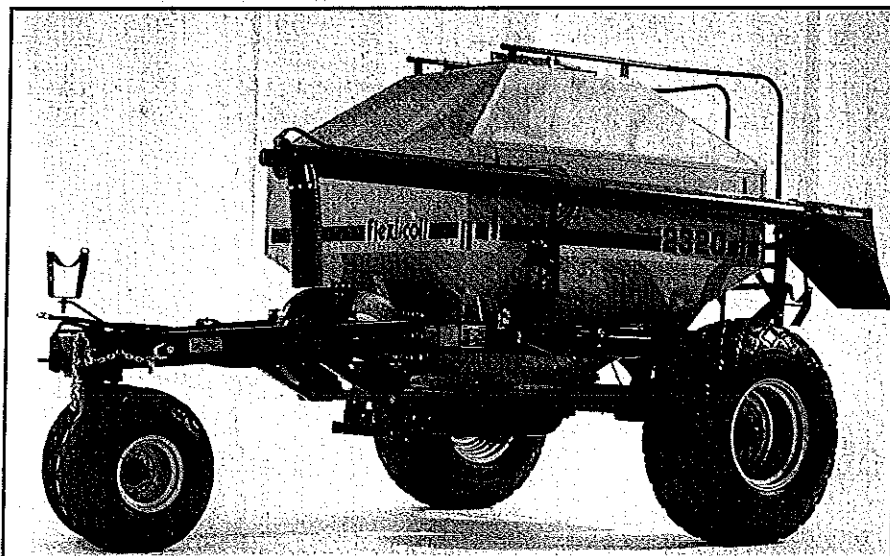

Grain Wagon Features Hydraulically Driven Conveyor-Unloading System

KINZE's 450C Conveyor Wagon, with a 490-bushel capacity, is intended for unloading combines and delivery to hauling trucks during harvest season. It fills the same requirements as auger unloading grain carts. A single section unloading conveyor folds on the side of the wagon for transport. The unloading conveyor is hydraulically driven, which allows it to be used with tractors that do not have a PTO. Intended for use with a variety of grain crops, including corn, wheat, beans and milo, the 450C features improved safety (no PTO), reduced grain damage compared with auger-type wagons, and reduced cost due to fewer moving parts. The conveyor is constructed using D81 chain typically used in the logging industry. The paddles are made from UHMW for reduced wear and reduced grain

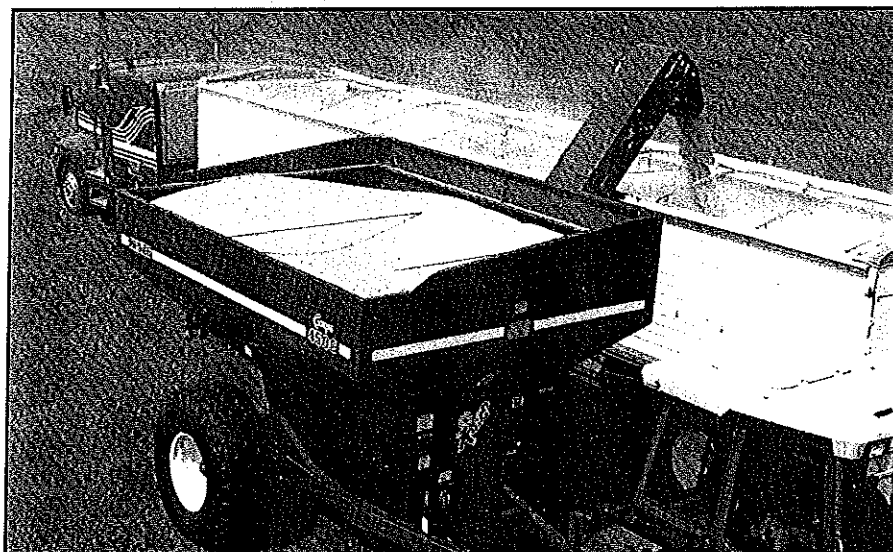

damage. The sequenced hydraulic system provides single valve control of all transport functions from the

tractor. KINZE Manufacturing, Inc, Williamsburg, Iowa, (319) 668-1300.

Deflector Pattern for a Low-Volume Irrigation System

The Proportional Butterfly™ pattern is a deflector pattern for the Rain Bird Micro-Quick irrigation system, a low-volume irrigation system for orchards and citrus groves. Designed to be placed halfway between the trees, the system, with its unique spray pattern, wets only the root zone under the canopy of the tree. It will not wet the trunk of the tree or spray water outside the natural root zone of the tree. The flow rate of each water stream exiting from the Proportional Butterfly™ pattern is sized to the area it covers, to achieve a uniform application rate. The outside grooves of the deflector are proportionally larger with a higher flow rate because they cover a much larger area than the center section of the wetted pattern, which is held short to keep the area around the trunk dry. The result is a more uniform irrigation. Rain Bird Sprinkler Manufacturing Corp., Glendora, California, (818) 852-7264.

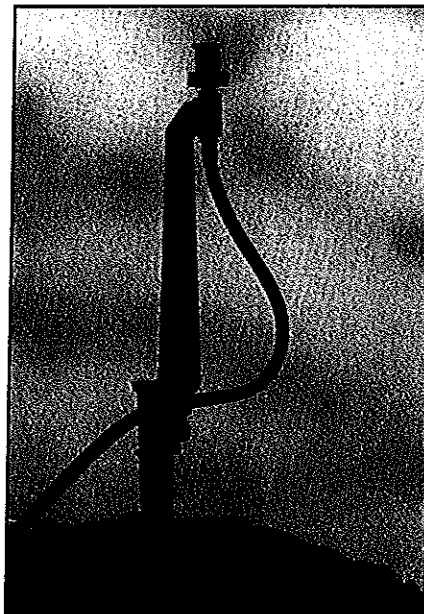

Mid-Range Agricultural Tractors are Completely Redesigned

The Ford New Holland six vehicle family of "Powerstar" tractors, equipped with an engine horsepower range of 70 to 120, is designed with increased displacement-high torque rise-more fuel efficient engines. Features include advanced transmissions with an electronic controlled-partial powershift-synchronized 16-speed shuttle transmission; a fully synchronized 12-speed shuttle transmission; new cab with improved ergonomics, comfort and reduced noise; and 7electronic draft control and load sensing hydraulics. A separate steering pump allows full use of variable pump flow without any effort on steering and gives excellent responsiveness at the "end of row" turn around with "high hydraulic demand" implements. The new driveline, hydraulic systems and operator



ease of control will enable operators to determine the optimum mode of operation to meet changing condi-

tions. Ford New Holland, Inc., New Holland, Pennsylvania, (717) 355-3158.

Integrated Electronic Systems for 'Powerstar' Tractors

The Ford New Holland mid-range family of agricultural tractors, the "Powerstar," is equipped with an **Integrated Electronic System** that features Pulse Command™, an electronic powershift transmission control subsystem; Electrolink II™, an electronic three-point hitch position and draft control subsystem; an electronically controlled 540/1000 speed shiftable PTO; and an instrumentation and field performance display center. User friendly controls provide field and equipment performance information feedback to operator through the use of microprocessor-controlled serial communications link and liquid crystal display techniques. Both resident and off-line software diagnostic strategies are used to monitor, analyze and maintain the equipment at the assembly plant, the dealership and at the end-user's location. Ford New Holland, Inc., New Holland, Pennsylvania, (717) 355-3514.

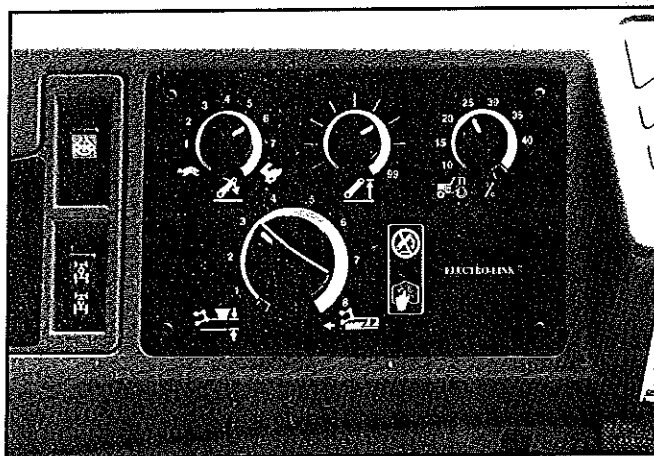

Disc Mower Conditioners Offer Simplicity

Gehl's DC2340 and DC2360 Disc Mower Conditioners have the entire drive mechanism mounted on and floating with the cutting head which eliminates the need for complicated power transfer system. The head is mounted to the trailer frame with a three-point flotation system that reacts faster to ground contours thus protecting the cutting mechanism. The cutting height is changed by pivoting the head forward or rearward by the means of a center link. The head is rotated on the skid shoes found under each cutting disc keeping all shoes in contact with the ground dividing the weight of the header equally among them. The gear case of the cutting mechanism is protected, isolated from foreign obstacles by

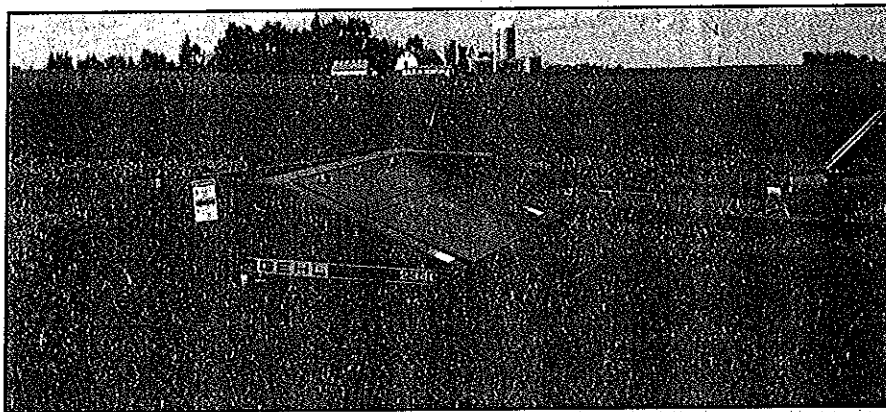

a full width cradle. A foreign object stuck in the field will come in contact with the cradle and not the cutter itself. The trail frame drawbar pivot point is located at the far left-hand side of the main frame and is con-

trolled hydraulically from the tractor seat. This allows the operator to steer around obstacles in the field and assists in making square corners. Gehl Co., West Bend, Wisconsin, (414) 334-6663.

Radial Farm Tire Designed for General Farming Service

The Goodyear DT710 Radial Farm Tire addresses the problems associated with tire lug-induced vibration on the road and accomplishes this objective through the use of a patented center element tread pattern. This allows comfortable ride and handling with low vibration and no reduction in tractive performance. A noted increase in traction as well as improvements in tread self-clean-

ing and wet soil mobility have been noted. The tire shape itself is a new generation CADAM/FEA design that defines a finely tuned natural shape carcass. The end result is a reduced stress construction that provides long term durability, low-pressure performance, and high-speed roading capability. Goodyear Tire & Rubber Co., Akron, Ohio, (216) 796-2858.



Modified Atmosphere Package Allows Picking and Packaging in Field

Weyerhaeuser's Modified Atmosphere Package for strawberries allows the berries to be picked and packed in the field. The packages are then palletized and transported to the cooler where they are brought down to holding and shipping temperatures. Made of a unique film that generates the Modified Atmosphere, the package requires no purging and/or addition of gas or gasses. This process reduces the rate of respiration and eliminates the growth of mold. As a result, the fruit remains in picked condition throughout a much longer life. Picking and packing at the same time minimizes the abuses to the fruit that would be expected from taking it to a processing shed for precooling and culling as is done now. The resulting

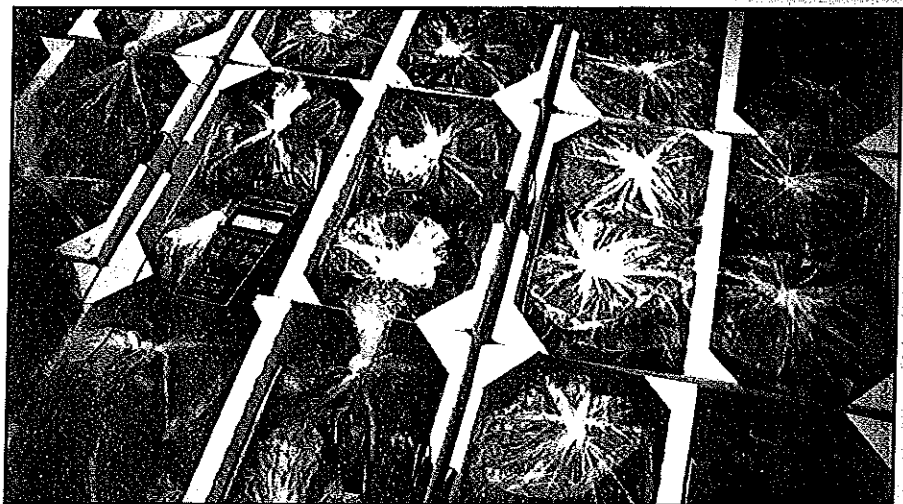

waste of shed packed fruit is not a factor in the field. Weyerhaeuser - Corporate Research and Engi-

neering, Tacoma, Washington, (206) 924-6339.

Bale Processor Delivers Entire Bale in Specific Lengths

Baled hay processed with Montano's MBP II Bale Processor is delivered with the entire bale almost intact — except cut into specific lengths. Putting the Montano Method™ hay into a mixer lets the mixer work more easily, provides an even, thorough blend in a much shorter mixing time and creates uniform delivery. It enables any mixer (3-auger, 4-auger, live floor, reel or drum), to mix desirable whole pieces of hay that have not been pulverized. The Montano Method produces produces hay feed with little or no waste, and does not create huge dust clouds. Benefits include increased longevity of mixer/feeder wagon and

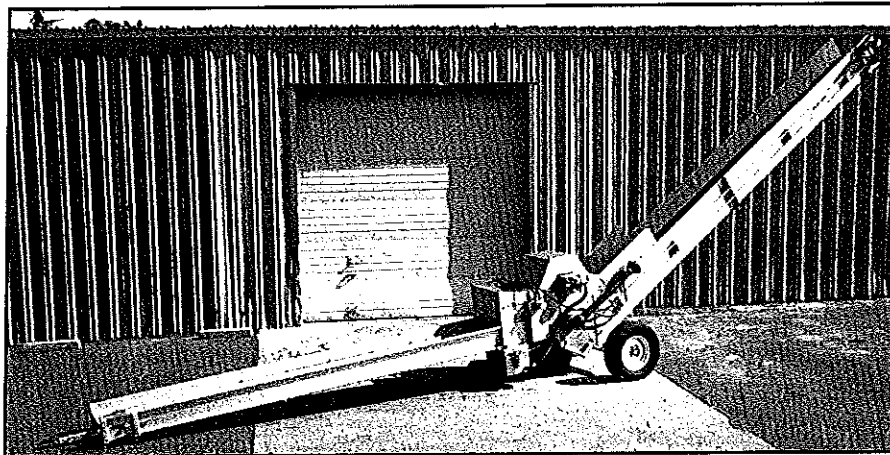

improved quality of hay feed to the animals. Montano Manufacturing, Inc., Merced, California, (209) 383-1443.

Telescopic ROPS Eliminates Removal From Tractor

Ford New Holland's Telescopic Rops, for use on low-profile tractors, permits the operator to lower the upper bar when in a low clearance work area, therefore, eliminating the necessity of removing the ROPS from the tractor. The upper bar can then later be raised for general purpose work. Raising the bar is assisted by a pair of springs located inside the upright legs of the ROPS. These springs counterbalance some of the weight of the upper bar. A pair of pins with hand grips are used to locate and hold the upper bar in its raised or lowered position. Ford New Holland, Inc., New Holland, Pennsylvania, (717) 355-3864.

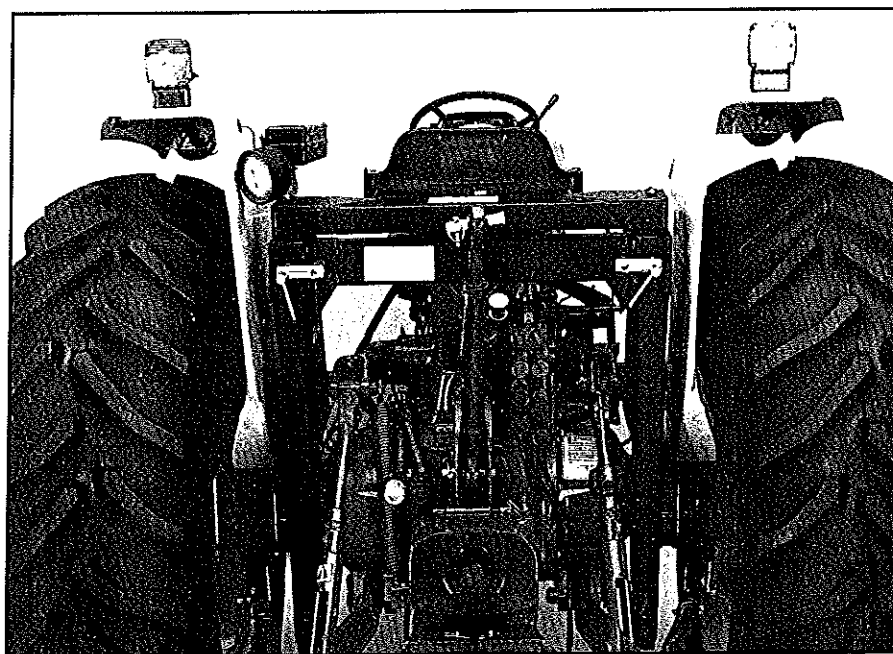

Lean Value Analysis Systems Use Scanning Technology

The MQI-Lean Value Analysis Systems, from Meat Quality Inc., use ELECTRO-Magnetic scanning technology to measure the amount of lean in meat products. The MQI ELECTRO-Magnetic scanning system consists of a low energy electrical field. Lean is more conductive than fat, therefore, as the meat passes through the electrical field it provides a nondestructive and accurate measurement of the amount of lean meat. The processor, by using ELECTRO-Magnetic scanning, can measure the leanness of the total animal carcass, primal cut, or boxed trimmings as they move through the production line. From this information, the processor can determine the market value of the meat. Meat Quality Inc. Division of AGMED Inc., Springfield, Illinois, (217) 793-3666.

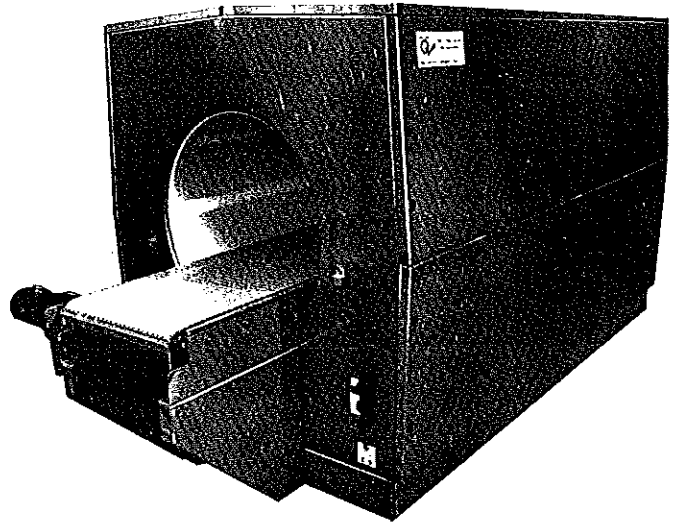

Sidehill Combine Features Hydraulic Leveling System

John Deere's 9500 SideHill™ Combine features a hydraulic leveling system with lateral leveling capability on slopes up to 18 percent. The system levels the entire combine body while the header pivots at the center to follow the terrain. The final drives and leveling mechanism are built as a unit and bolted to the front axle. An adapter casting centers the transmission on the front axle, allowing a common driveshaft for both the left and right sides. The lower front corners of the sidesheets were trimmed to make clearance for the propulsion driveshafts. The header lift cylinders are mounted from the final drive structure. Telescoping driveshafts with constant velocity U-joints transmit power from the transmission to the final drive pinions,



eliminating an internal chain drive from previous designs. John Deere

Harvester Works, East Moline, Illinois, (309) 765-2033.

Variable Core Density Valve Allows Adjustment to Reduce Hydraulic Pressure

Deere & Co.'s Variable Core Density Valve is available for John Deere 435 or 535 balers. It provides a simple, inexpensive way to vary the size of a softer-than-normal bale "core" as the bale is formed in the baler. The attachment works by lowering belt tensions while the bale core is forming, then returns the belt tension to normal at any size the operator desires. The unit can be adjusted for soft cores from just a few inches in diameter up to the entire bale being soft, and anywhere in between. The unit consists of a 12VDC solenoid valve, which installs in the baler's belt tensioning valve, and a cam-actuated switch, to turn the valve on and off as the bale grows. When soft core bales are desired, the cam is adjusted to turn the solenoid valve on (for soft core) when the baler is empty. As the bale grows, the cam rotates and turns off the solenoid valve, returning the baler tension system to high density. Deere & Co., John Deere Ottumwa Works, Ottumwa, Iowa, (515) 683-2473.

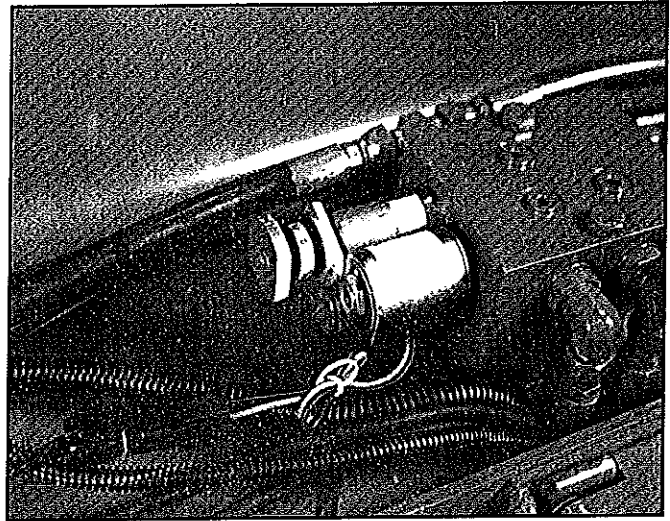

Adjustable Row Cotton Picker Harvests a Range of Row Widths

The J I Case 2055 Adjustable Row Cotton Picker is designed to harvest cotton in four or five narrow (30-in.), four-row conventional (38-and 40-in.) and multiple skip-row configurations. Features include powered-metered unloading, on-board lubrication, all gear-driven drums and front and rear rotors that allow picking from both sides of the row. Rotation of drums can be reversed if necessary to unplug vines and other material while a Protec-O-matic clutch assembly protects the rotors in both forward and reverse directions. Drum serviceability is hydraulically controlled to allow easy accessibility to rear rotors, moistener stands, doffers and conveyor doors. The 2055 is powered by an after-cooled turbocharged 8.3 liter diesel

engine rated at 266 hp with picking speeds of 0 to 4.3 mph. J I Case,

Agricultural Equipment, Hinsdale, Illinois, (708) 887-2217.

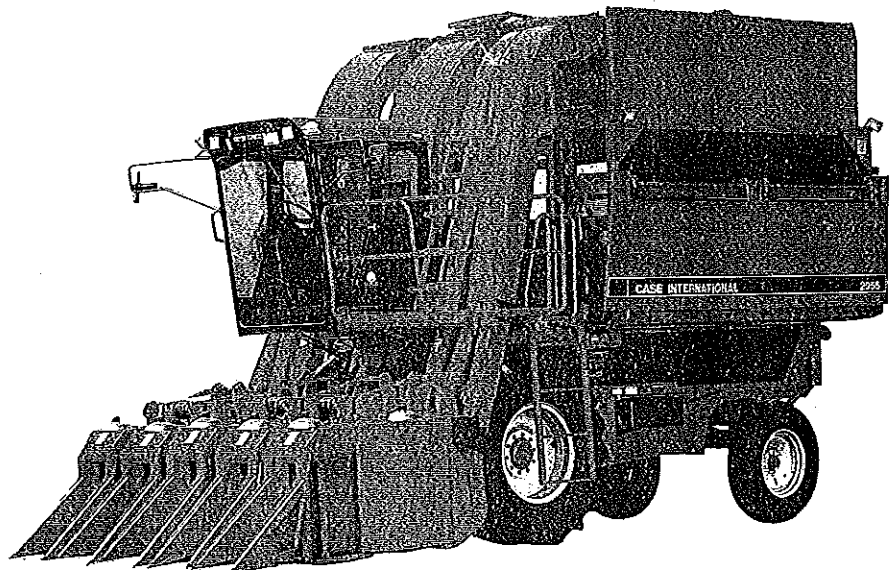

Reactionary Drive Sprinklers Feature Rotary Dampener

Nelson's Rotator™ family of sprinklers have only one moving part — the rotor shaft. The Rotator has no drive arm; no bearings, seals or washers exposed to water pressure; and no springs to wear or break. Major causes of problems in conventional impact sprinklers have been eliminated. The Rotator uses a patented drive principle. The water stream emitting from the nozzle is directed into an offset channel on the rotor plate creating a reactionary drive force. The rotation speed is

controlled by a viscous silicone fluid in the rotor housing. The rotary dampener feature of the sprinklers results in large coverage and allows them to be used at maximized sprinkler spacing. In orchard application, there is no drive arm to cause water splash damage to the fruit. On center pivot systems, the water use efficiency is increased because of low mounting height on drop pipes. Nelson Irrigation Corp., Walla Walla, Washington, (509) 525-7660.

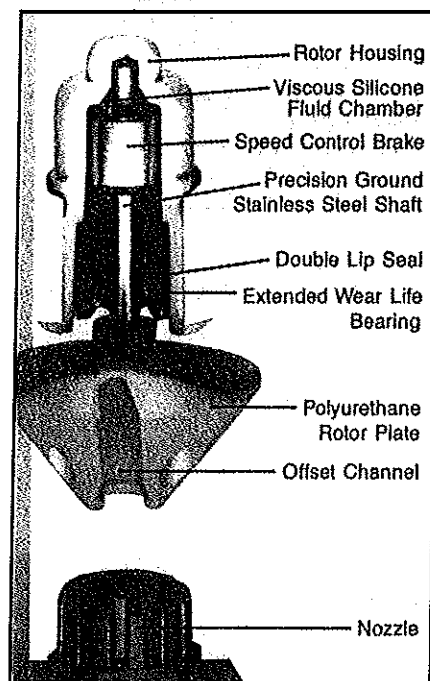

An Automatic Transplanting System for Mulch-Covered Beds

Renaldo's "Posi-Flow" Plant Setting System is designed for setting transplants through plastic mulch-covered beds. The planter is capable of spacing plants in the 8- to 24- inch range. The system has the ability to burn the hole, set the plant, water and press the plant tight in one operation. Each unit is independently tool-bar mounted and capable of being narrowed to a 12-inch side by side mounting. Although the system is intended for plastic mulch, it will work equally as well on bare ground. The "Posi-Flow" plant setting system will be available in both Fully Automatic and Semi-Automatic versions. Both units utilize the same unit and ground engaging components. The Fully Automatic version, which requires one laborer to load full trays of transplants and unload empty trays, is capable of using a variety of different commercially available trays without any modification to the tray. The Semi-Automatic system would require one laborer per unit to place individual plants into the machine. Renaldo's Sales & Service, Inc., North Collins, New York, (716) 337-3760.



Folding Grain Drills Offered in Two Sizes

John Deere's 455 Series Folding Grain Drills are offered in a two-section 25 and a three-section 30-foot model, each with in-line grain boxes for easy filling. They are available with 6-, 7.5-, or 10-inch. row spacing. Features include constant hydraulic down force and offset double disk openers designed for seeding small grains and soybeans. The highly flexible and easily adjusted system improves seed placement and productivity in level, rolling or terraced fields. Each opener can independently flex vertically more than 15 inches in field working position. Continuous tractor hydraulic power provides constant down pressure to the openers on uneven terrain, resulting in improved seed placement and seed-to-soil contact. Down force on all openers is easily adjusted to an infinite number of settings with one pressure control valve. Convenient and easy adjustments for opener depth gauging provide depth settings in .35 inch increments and can be done quickly with one hand without use of tools or removal and replacement of pins. A variety of press wheel sizes and shapes are available. **John Deere Des Moines Works, Des Moines, Iowa, (515) 289-3040.**

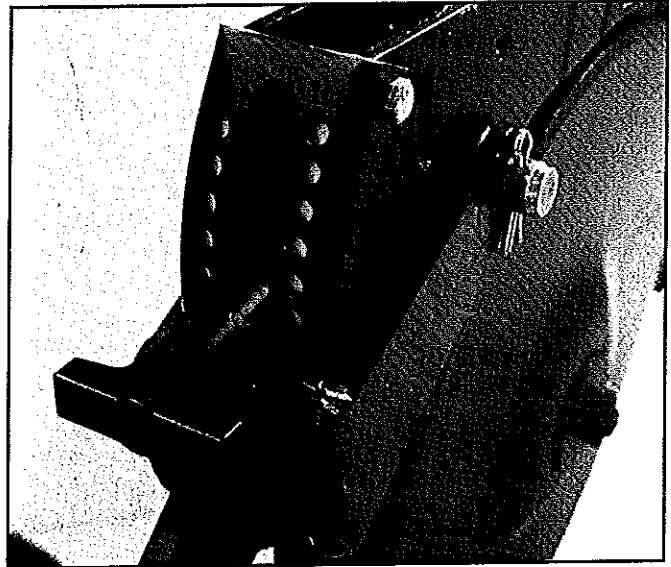

Chemical Sprayer Broadcasts Directly on Targeted Plants

The Progressive Spot-Shot chemical sprayer is front-mounted on a tractor for site specific application. The unit can be configured to cover from 4 to 16 rows of crops simultaneously. The Spot-Shot consists of three main components: infrared sensors for each row of crops, a control box and the sprayer system. Sensors detect anything that breaks the light beam causing the system to trigger the chemical application (herbicide, fertilizer, pesticide). Mounted in the cab, the control box monitors and controls the spraying. Lights flash to show when each individual row nozzle opens. The sprayer can be used in auto, manual or all rows on continuously modes. The sprayer system, with the exception of the solenoid valves, can be constructed with conventional sprayer parts in a

variety of spray nozzle configurations to develop the desired spray pattern.

Progressive Farm Products, Inc.,
Hudson, Illinois, (309) 454-1564.



Sprayer Boom Component Simplifies Changing Spray Nozzles

Spraying Systems' #24230 Quick TeeJet® Triple Nozzle Body is a multi-indexing sprayer boom component designed to retrofit on all existing dry or wet boom systems and simplify changing spray nozzles in the field. The wet boom version consists of a triple nozzle body that can fit on 1-, 3/4- or 1/2-inch sprayer booms. The dry boom version consists of hose connections, either single or double, in 1/2 inch or 3/4 inch. The triple-nozzle body is constructed of a nylon body and turret, stainless wire clips and EPDM (Viton optional) o-rings and diaphragm. It is rated at 125 psi maximum operating pressure. Choice of nozzle can be made with a simple "twist of the wrist." Spraying Systems Co., Wheaton, Illinois, (708) 665-5000.

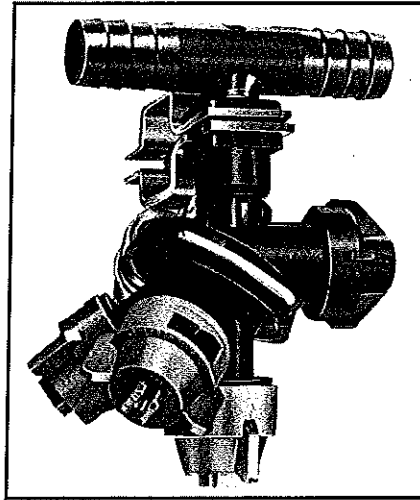

Controlled Irrigation System Provides Efficient Water Supply to Container-Grown Crops

Q-Com's Closed Loop Computerized Soil Moisture Tensiometer (SMT) Controlled Irrigation System is an integrated system of electronic soil moisture sensors, activators and computer controls. The system is capable of sensing soil tensions of .1 to 25 kPa, with accuracy of $\pm .1$ kPa. The soil moisture probes can be placed in pots as small as 3 inches. These probes can be located up to 5,000 feet away from the host computer using the greenhouse's existing 115 VAC wiring for bidirectional powerline carrier communication. The SMT provides accurate, reliable irrigation, and the host system software provides automatic "representative pot" recalibration of the entire population, using leeching or dry down overrides. The software runs on IBM compatible computers and it communicates to the remote SMT units via powerline carrier 200 KHZ FSK communications. Communications between the host computer and the remote SMT operate normally to 5,000 feet. The system has options for radio and twisted pair communications for field irrigation requiring longer distances. Q-Com Corp., Irvine, California, (714) 833-1000.

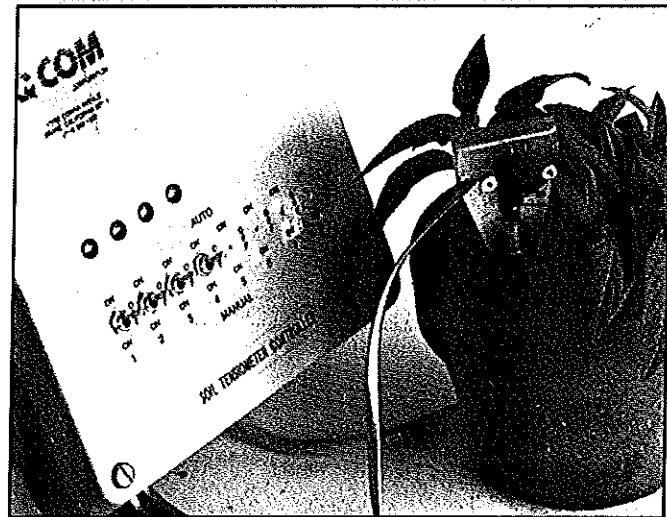

Automatic Guidance System Converts Mounted Equipment to Pull-Type

Progressive's Auto Kaddy incorporates electronic signals to operate hydraulic steering controls that articulate a pull-type caddy system. The system gives the farmer the ability to carry larger implements with smaller horsepower tractors by removing the implement from the tractor's three-point hitch and placing it on the caddy. With the addition of a 500 gallon spray tank, the Auto Kaddy can be used for application of fertilizers and chemicals. The use of the computer control console mounted in the tractor cab allows the operator to control the steering and gives a digital readout of acres, speed, acres per hour and gallons per acre

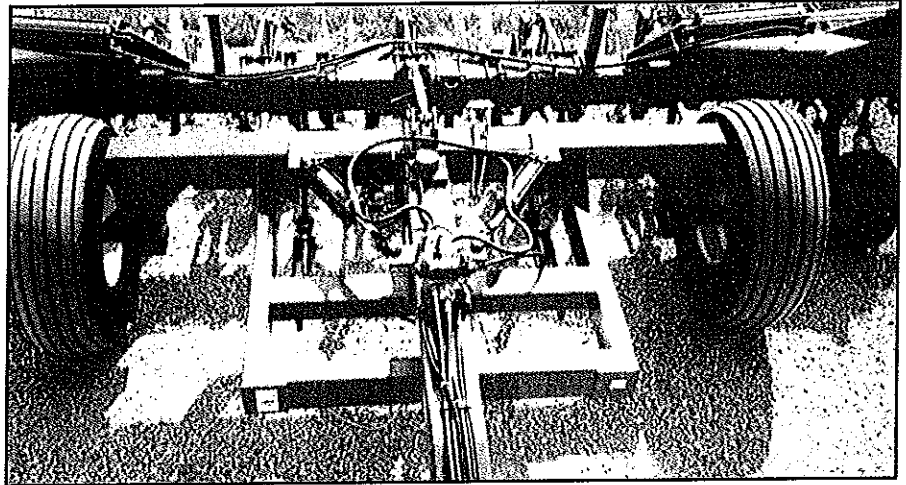

applied. The system works with any tractor. Progressive Farm Prod-

ucts, Inc., Hudson, Illinois, (309) 454-1564.

Swivel Hitch Increases Ability to Make Sharp Corners

Ford New Holland's Swivel Hitch complements the disc mower-conditioners fast cutting with its ability to make sharp corners quickly and effortlessly. The swivel hitch consists of a pair of identical right-angled gearboxes mounted on the front tongue portion of a towed implement. PTO power is delivered from the tractor via a PTO drive shaft assembly to a lower right-angled gearbox. This gearbox is mounted to a sub-frame that attaches to the lower links of the tractor's three-point hitch. A second, identical gearbox is mounted to the tongue of the towed implement so that it is directly above the lower gearbox. The output shaft of the lower gearbox is rigidly coupled to the input shaft of the upper gearbox. The output shaft of the upper gearbox is rigidly coupled to the secondary drive shaft of the

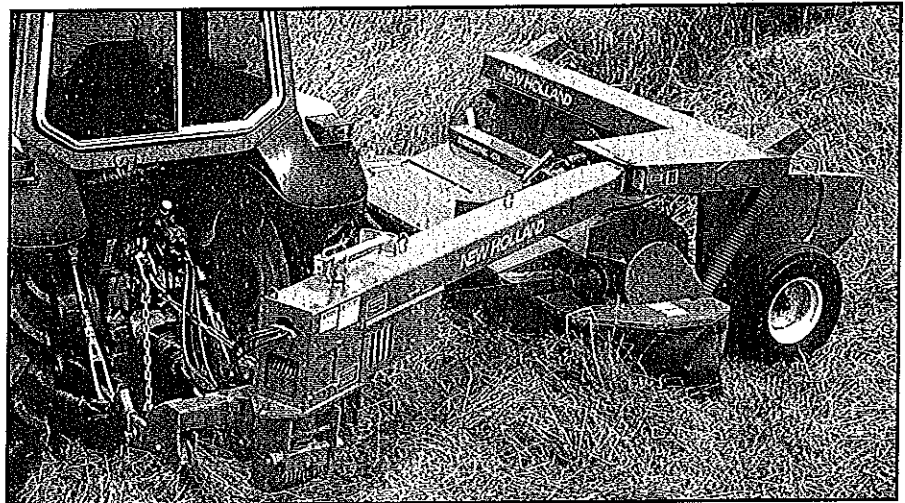

implement. The sub-frame, lower gearbox and primary PTO assembly are always held in a fixed relationship to the tractor. This allows the tractor to make relatively high turn

angles without affecting the geometry of the primary drive. Ford New Holland, Inc., New Holland, Pennsylvania, (717) 355-3864.

Management Package Controls and Monitors Center Pivots

The C:A:M:S (Computer Aided Management System) Base Station, from Valmont, is a management package that controls and monitors mechanized sprinklers and pumps from a home or office computer using radio telemetry. The Base Station, an extension of the C:A:M:S pivot panel, consists of a mouse-driven, customized graphical software package for use in agriculture, and a radio modem to communicate to each unit. The control system can be summarized by the following points: monitor and control of pivot sprinkler, water pumps and chemical application pumps from an office PC; programmable control of the units from the computer; logging of important data to confirm water application amounts, date and time of operation, and chemical application run time; customized CAD program to allow individuals to generate an overview of the farm; customized user defined alarm levels; and diagnostic capability. Valmont Industries, Inc., Irrigation Division, Valley, Nebraska, (402) 359-2201.

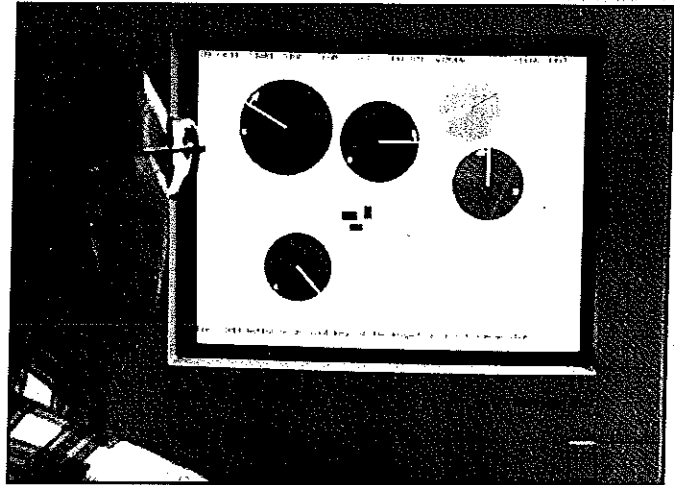

Phase-Controlled Impact Shaker is Low-Powered

The R&O Model VM 06 phase-controlled impact shaker, from Reynolds & Oliveira Lda., is a low power (10 to 20 hp) shaker for olive, nut and prune trees either for trunk or limb, but especially suited for 8 to 50 cm diameter trunk shaking. It can be used as a tractor-mounted shaker on a front-end agricultural loader. It is easily and quickly attached to a tractor in front or rear using three-point hitch linkage. It can be used as a self-propelled shaker with a small skid-steer loader or even with a small monoboom provided that they have more than 25 hp. The R&O phase-controlled impact shaking technology on a 0 to 8 Hz frequency and up to 35 tons of impact (using low speed, simple and reliable hydraulics) removes 80 percent of fruit with the first impact and 20 percent with the four subsequent impacts. This takes an average of three seconds for fruit removal per tree. It also maximizes

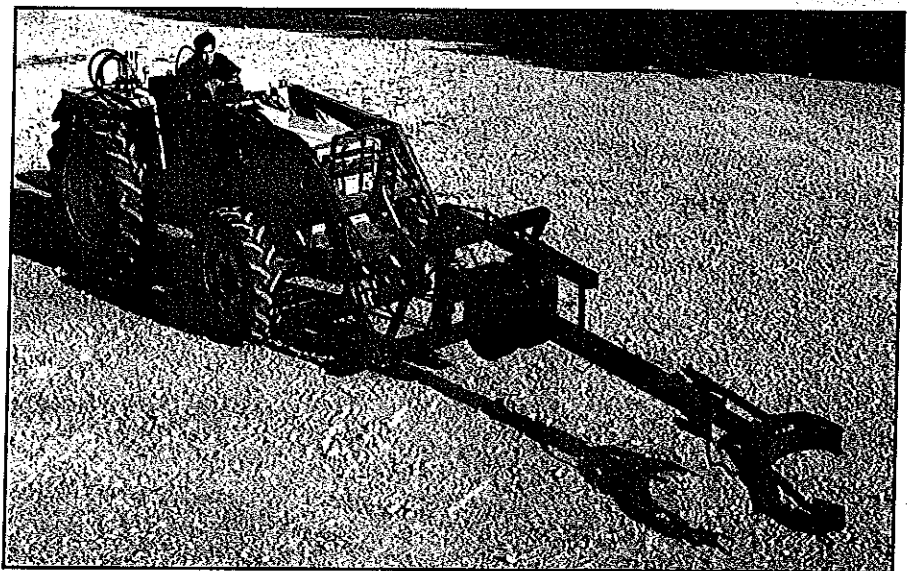

impact energy transmission with lower input energy and less tree or bark injury because the shaker uses the tree's natural frequencies for shaking. This provides faster and

higher fruit removal efficiency, producing vertical fruit fall, and much less leaf and small limb detachment. Reynolds & Oliveira Lda., Lisbon, Portugal, fax (011) 351-1-315-1893.

Telescoping Agricultural Drivelines Sealed From Contamination

Weasler's Sealed Telescoping Members for Agricultural Drivelines eliminate contamination of the lubricant, which results in increased life and reduced thrust loads. The new seal design allows agricultural drivelines to telescope 10 to 20 inches, and be sealed at all lengths. When in dirty or contaminated environments, the sealed telescoping members will not increase in thrust or vibration. The ability to seal the telescoping area will allow for the

use of nonmetallic coating in order to reduce the telescoping forces in thrust load sensitive applications. The design uses a urethane lip seal. The sealed telescoping members allow agricultural implement engineers to use long slip lengths and still remain sealed, while reducing the thrust loads being transmitted to adjoining members. Weasler Engineering, Inc., West Bend, Wisconsin, (414) 338-2161.

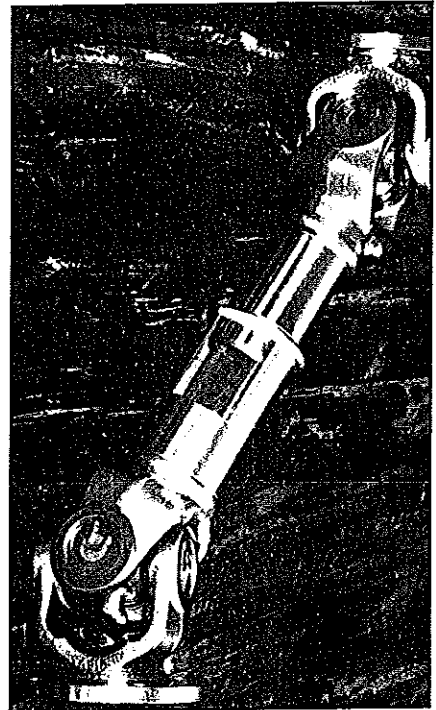

Factory-Assembled Planters Built to Specific Order

John Deere's MaxEmerge® and MaxEmerge™2 planters had previously been shipped in bundle (knocked down) configuration. The planters are now assembled complete in the factory. The line includes 44 different frame sizes and configurations with a wide variety of options. The factory-assembled process provides hydraulic and electrical testing and shipping in returnable shipping stands that provide improved handling and storage at the dealer. John Deere Harvester Works, Moline, Illinois, (309) 765-7531.

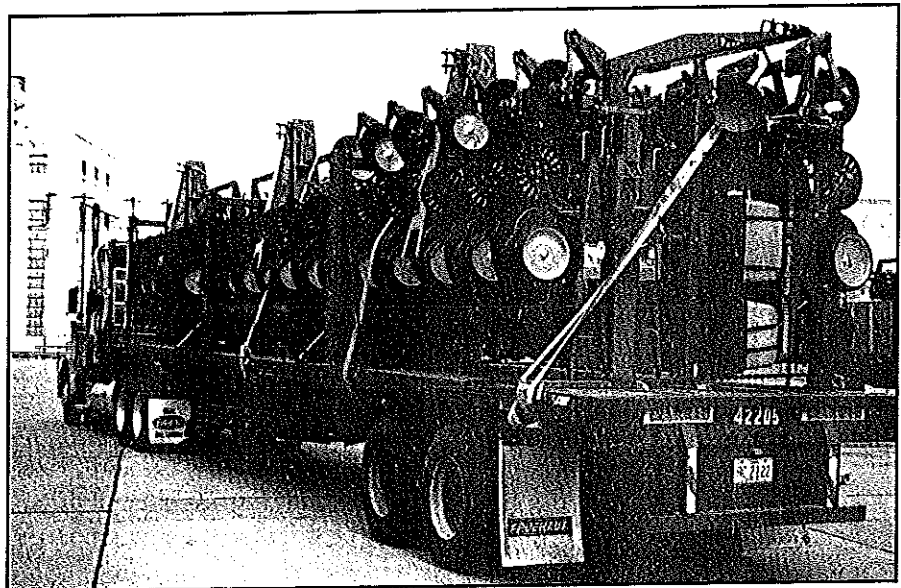

System Reproduces Tea Manufacture in Miniature

The Environmentally Controlled Manufacture (ECM) Mini-Manufacturing System from Teacraft reproduces in miniature each unit process of conventional tea manufacture. Using environmental control techniques, the mini-manufacture system completely reproduces any combination of factory conditions without the confounding effects of ambient conditions fluctuation. The system requires little raw material. It can produce tasting samples from a single bush, therefore, is ideal for clonal evaluation. It can reproducibly process plot and field trial treatments. It is ideal for optimizing unit process conditions allowing the use of "what if" situations. The system is rugged and proven under tea factory conditions. Processes under your control include withering temperature and time, rate of moisture loss, fermentation temperature and time, drying temperature and airflow. Teacraft, Bedford, United Kingdom, fax (011) 44-234-353889.

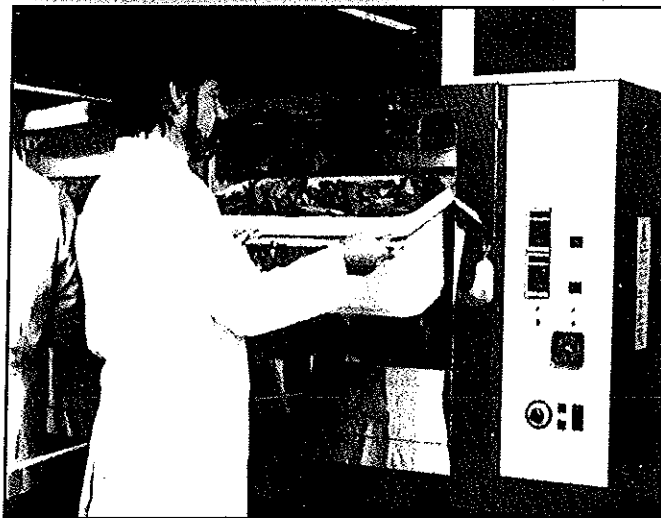

Pull-Type Road Grader for Non-Hardsurfaced Roads

The Raynetainer from Raynetainer is a pull-type machine designed specifically for the maintenance of non-hardsurface roads — public, private, and logging roads and fire lanes. The Raynetainer smooths the surface of any non-hardsurfaced road by moving the loosened base material and stabilizing agent(s) laterally, to travel the shortest possible distance, as opposed to Land Planing (leveling), which usually requires moving the loosened soil longitudinally. With a 70 hp tractor, a lesser skilled operator (with owner/operator manual) may grade roads at speeds of from 3 to 7 mph. The Raynetainer has the proper weight distribution to lineal feet of blade to properly shear the tightly set up material and with a full float striker blade, properly redistribute that material leaving a smooth road surface. Raynetainer®, Inc., Rayne, Louisiana, (318) 334-2101.

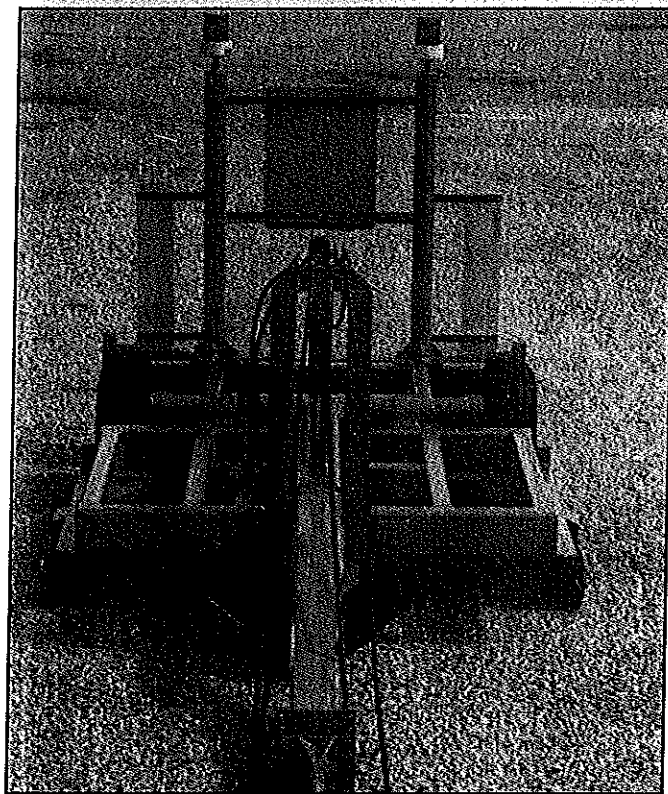

- AGCO Engineering Group**
Rotary "Gleaner" Combines
Page 7
- AMADAS Industries**
Portable Trommel
Page 6
- Aerotech, Inc.**
Advantage® Direct Drive Fans
Page 5
- Ag-Chem Equipment, Inc.**
Chemical Metering and
Distribution System*
Page 6
- Automata, Inc.**
AQUA-TEL Soil Moisture Sensor
Page 8
- Bush Hog R&D Center**
Four-Row Peanut Combine
Page 4
- Campbell Scientific, Inc.**
Soil Moisture Measurement System
Page 7
- J I Case - Ag Equipment Center**
Combo-Mulch Finisher
Page 8
- J I Case - Ag Equipment Center**
Folding Grain Drill
Page 4
- J I Case - Ag Equipment Center**
Moldboard Adjustable Width of
Cut Plow
Page 15
- J I Case - Ag Tractors**
Magnum Tractor
Page 10
- J I Case Ag Equipment Center**
Adjustable Row Cotton Picker
Page 22
- The Celotex Corporation**
Thermax® Blackore™ Insulating
Sheathing
Page 10
- Chore-Time Equipment**
Dual Curtain Control
Page 9
- John Deere Des Moines Works**
Folding Grain Drills
Page 24
- John Deere Engine Group, Product
Engineering Center**
Dual Fuel Engine
Page 12
- John Deere Harvester Works**
MaxEmerge®2 Planter Lines
Page 28
- John Deere Harvester Works**
CTS Rice Combine
Page 11
- John Deere Harvester Works**
SideHill™ Combine Harvester
Page 21
- John Deere Ottumwa Works**
Variable Core Density Valve
Page 22
- DeImhorst Instrument Co.**
Hay Moisture Meter
Page 14
- Dickey Machine Works**
IncorpoVator™ Seedbed
Preparation/Incorporation Tool
Page 9
- Dynamax Inc.**
Sap Flow Monitoring System
Page 15
- FINAGRI/EDIL Division**
AQUALOG Computerized Irrigation
Control System
Page 13
- Flexi-Coil Ltd.**
Air Seeder Cart
Page 16
- Ford New Holland, Inc.**
Swivel Hitch
Page 26
- Ford New Holland, Inc.**
Telescopic ROPS
Page 20
- Ford New Holland, Inc.**
"Powerstar" Tractors
Page 17
- Ford New Holland, Inc.**
Integrated Electronic Systems for
"Powerstar" Tractors
Page 18
- Gandy Company**
Chemical Metering and Distribution
System*
Page 6
- Gehl Company**
Disc Mower Conditioners
Page 18
- Goodyear Tire & Rubber Company**
Radial Farm Tire
Page 19
- Guymon Manufacturing Company**
Emergency Ventilation System
Page 11
- Kinze Manufacturing, Inc.**
Conveyor Wagon
Page 16
- Kubota Corporation**
4WD Front Mower
Page 13
- Meat Quality Inc.,
Division of AGMED, Inc.**
MQI-Lean Value Analysis System
Page 21
- Montano Manufacturing, Inc.**
Bale Processor
Page 20
- Nelson Irrigation Corporation**
"Rotator" Family of Sprinklers
Page 23
- Optek, Inc.**
Continuous Flow Dryer Control
Page 5
- Orthman Manufacturing Inc.**
CSC Harvester Guidance System
Page 14
- The Pirelli Armstrong Tire
Corporation, R&D**
Industrial Skid-Steer Drive Tires
Page 12

*Joint development

Progressive Farm Products, Inc.
Auto Kaddy Automatic Guidance
System
Page 26

Progressive Farm Products, Inc.
Spot-Shot Sprayer
Page 24

Q-Com Corporation, Inc.
Closed Loop Computerized Control
of Soil Moisture Tensiometer-
Controlled Irrigation
Page 25

**Rain Bird Sprinkler Manufacturing
Corporation**
Proportional Butterfly™ Pattern
Page 17

Raynetainer, Inc.
Pull-Type Road Grader
Page 29

Renaldo's Sales & Service, Inc.
"Posi-Flow" Plant Setting System
Page 23

Reynolds & Oliveira Lda.
Phase-Controlled Impact Shaker
Page 27

Spraying Systems Company
Quick TeeJet® Triple Nozzle Body
Page 25

Teacraft
ECM Tea Mini-Manufacturing System
Page 29

**Valmont Industries, Inc.,
Irrigation Division**
C:A:M:S — Computer-Aided
Management System Base Station
Page 27

Weasler Engineering, Inc.
Sealed Telescoping Members for
Agricultural Drivelines
Page 28

**Weyerhaeuser
Corporate Research & Engineering**
Modified Atmosphere Package for
Strawberries
Page 19

QUALITY PRODUCT. QUALITY PROMOTIONS.

We can help you promote your "AE 50" award.

Agricultural Engineering wants to help you promote your award-winning product to your customers. And we can help you reward the employees who played a part in developing your product. Ask us about the following services:

➤ Complete copies of the September issue of *Agricultural Engineering* magazine that contains "The AE 50" section. Ten are provided free. Additional copies are \$3 each.

➤ Front cover of "The AE 50" section with your innovation described on the reverse side — 20 cents per copy, minimum order 300.

➤ Official gold imprinted "AE 50" recognition mug — \$10 each. Great gift for employees.

➤ Replica of plaque presented to company with description of honored product — \$24 each.



AGRICULTURAL ENGINEERING
2950 Niles Road
St. Joseph, MI 49085-9659
(616) 429-0300
fax (616) 429-3852

Contact: Dee Gunn