

Salute to the AE 50

To be named among the winners of the annual **Agricultural Engineering 50** award is to be held in high esteem by one's peers — designers, developers, users and others active in the diverse fields of engineering in agriculture. It is an honor bestowed in recognition of innovation of a high order.

Showcased with this section are the top engineering developments in agriculture introduced to the marketplace during 1990. Virtually all companies supplying components, making products, or developing systems for food and agriculture were eligible to submit for consideration "developments that embody the application of new technology or the innovative application of an older technology."

A distinguished panel of engineering experts from several well-known organizations reviewed the entries to select those considered most likely to make a "worthwhile contribution to the advancement of engineering technology in food and agriculture."

Agricultural Engineering magazine is proud to play an important part in making known these significant developments in engineering technology. The products and processes showcased here feature many innovations that will help farmers, processors and equipment manufacturers to cut costs, enhance quality, boost nutrition, become competitive and improve profitability. We salute all the researchers, innovators, designers, planners, managers and supporters that make these new products possible. It takes teamwork to bring innovation to market! To all our honorees — here is our AE 50 salute for 1991!



System Targets Trees' Shape Before Spraying

The Crop Care System from FMC's Agricultural Machinery Division integrates a computer-controlled sprayer control system into the FMC orchard airblast sprayer product line. The system determines the shape of the target trees through ultrasonic sensors while an on-board computer is able to tailor the chemical spray pattern to more precisely match the shape of the tree. The computer also adjusts the total spray output to maintain an accurate flow rate to match the ground speed of the vehicle. The control system maintains a constant pressure within the fluid manifolds regardless of the flow. Its ability to compensate accurately and instantaneously to the ever-changing flow rates required by the tailoring of the spray pattern provides an exact chemical distribution. Cum-

mins diesel power drives the self-priming, two-stage Bean centrifugal pump, which is capable of delivering a full range of application rates from 25 gpa to 1,500 gpa. The 500-gallon stainless-steel tank is constantly agitated by stainless-steel paddles to keep the chemicals in solution. Models for both engine-driven air

sprayers and PTO driven are available. A flow measurement system is also installed to allow for the accumulation of the output data that can be stored and retrieved by the user for record-keeping purposes. **FMC Corporation**, Agricultural Machinery Division, Jonesboro, Arkansas, (501) 935-1970.

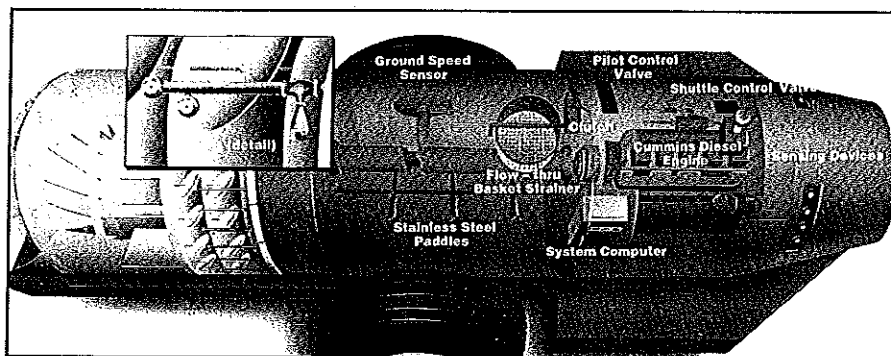

Trailer Air-Assisted Boom Sprayer

Hardi Inc.'s Twin System reduces spray drift and optimizes penetration with adjustable air speed and spray direction that gives spray droplets more energy to reach and cover even the most difficult targets. The twin system allows for low-volume spraying. It retains all the

assets of the traditional hydraulic nozzle sprayer, but is further refined, using an axial fan that blows air through a swath-wide air bag. Air is emitted as a continuous full-width curtain through a 1-inch slot to follow at a fixed position relative to the nozzles. The air curtain can be

angled 30 degrees either side of vertical to facilitate spray penetrations and compensate for wind direction. The twin system also offers built-in control, pump, and a spray line flush system to clean the sprayer between chemical usage. **Hardi Inc.**, Davenport, Iowa, (319) 386-1710.

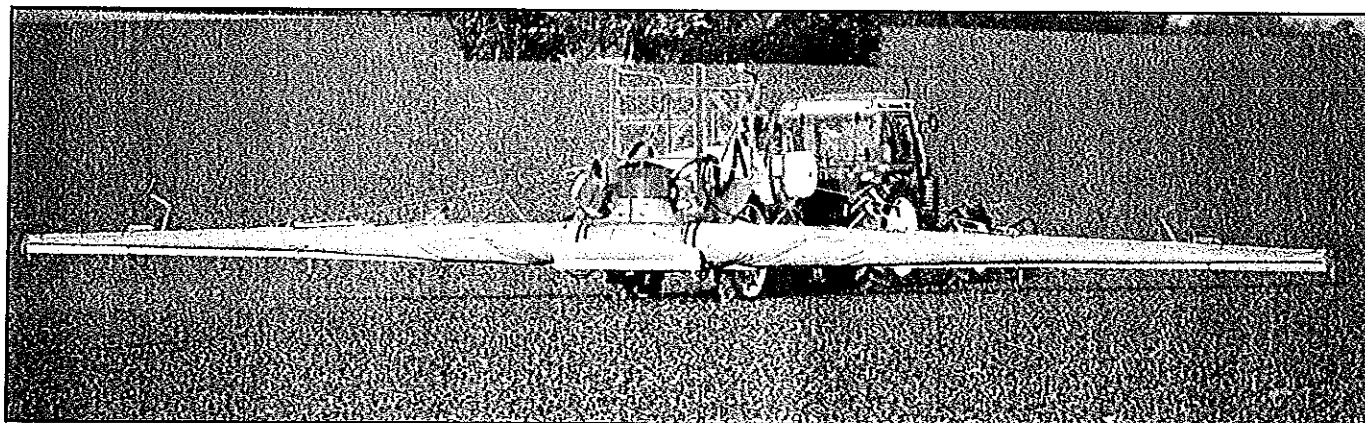

Vacuum Kills Insects on Impact

Sukup's tractor-mounted Bug Beater uses in-line centrifugal fans positioned above each plant row to draw in insects, killing them upon impact with the fan blade and the housing. While many insects have developed resistance to chemical insecticides, this method of eradication does not require any chemicals, chemical operator's license, or special collection devices. The dead insects are simply redeposited on the field. Bug Beater also uses a special type of shroud that covers the plant to maximize suction. Within this shroud the system recirculates air between the fan and the crop for maximum vacuuming efficiency. The units may be mounted on the rear or front of tractors and are powered by the PTO. This design allows easy

change in the structure to accommodate various sizes. Sukup Manufac-

turing Company, Sheffield, Iowa, (515) 892-4222.



Automatic Grain Moisture Controller

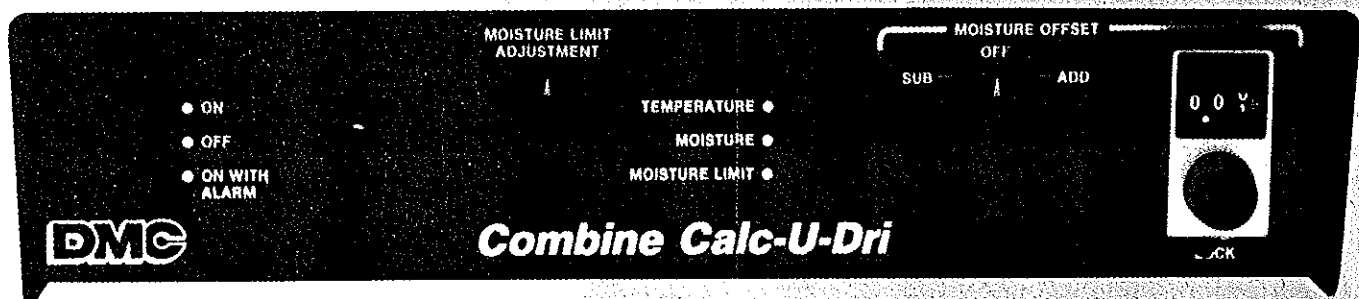

David Manufacturing's Combine Calc-U-Dri is a moisture sensing piece of electronic equipment designed specifically to be mounted inside the cab of a combine to enable the operator to constantly monitor the moisture content of the grain as it is being harvested. It consists of three main components: the sensing

unit, the control box and the digital display unit. The sensing units are placed in the clean grain auger in the grain tank of the combine. The control box is mounted in the cab. The sensor unit provides accurate and reliable grain moisture values. The Calc-U-Dri sensor incorporates dual-tuned circuitry and sends a voltage

signal from each circuit to the control box. The Combine Calc-U-Dri is powered by 12 volts DC, however, some farmers are using 110VAC to 12VDC converters to use it as a moisture monitor for a variety of materials. David Manufacturing Company, Mason City, Iowa, (515) 423-6182.

Versatile Cotton Picker

John Deere's model 9960 MVP (Most Versatile Picker) Cotton Picker is the first spindle picker

designed to pick 762 mm (30 in.) solid planted cotton. A narrow picking unit has been developed by plac-

ing both picking drums on the same side of the row. The 9960 allows the farmer to pick four or five narrow rows (30 inches), four conventional rows (38 or 40 inches) or two-and-one skip row. The 9960 also contains slip-clutch protection with a slip clutch on every drum unit. New on-board lubricating allows for easier servicing. A gear-driven doffer eliminates chain drives. The spindles approach the doffers at a more natural angle. The MVP provides single duct capacity to remove the difficulty of sharp bends into the chutes. The unit is driven by a 6-cylinder, 7.6-liter (466 cubic inches) 250-hp diesel turbocharged aftercooled engine with picking speeds of 0-4.2 mph and pavement speeds of 0-14.2 mph. John Deere Des Moines Works Des Moines, Iowa, (515) 289-3055.

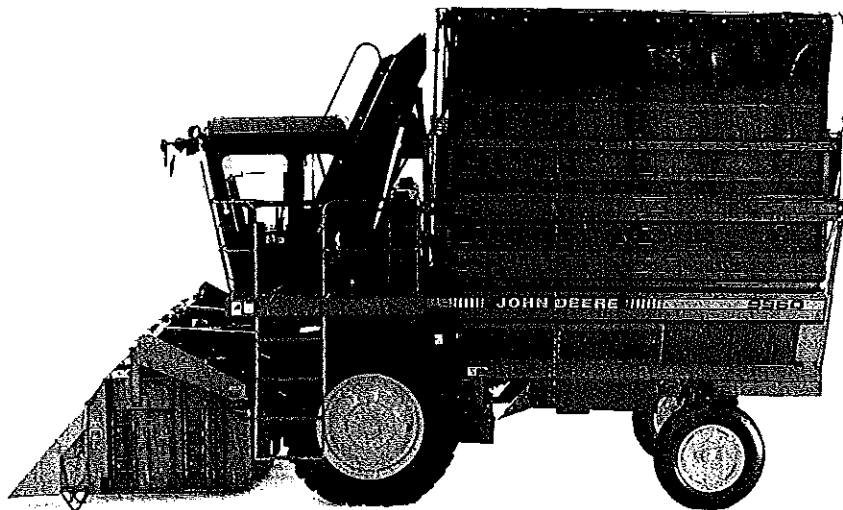

Four- and Six-Row Peanut Combines

Magnum Fource Four- and Six-Row Peanut Combines from AMADAS Industries are tractor towed, PTO powered, and require 130 hp or more to operate. The Magnum Fource combines harvest two, two-row windrows and three, two-row windrows at speeds equal to or greater than those achieved with pre-existing two-row peanut combines. Inverted peanut vines are lifted from ground and passed into the picking and cleaning chambers, where they are picked, separated and cleaned. Cleaned peanuts are pneumatically carried up to a holding bin and the vines are passed out the back. Dirt exits through concave openings under the picking cylinders, as well as through the air-separation system and stemmer bottom. The Magnum Fource line was designed and manufactured with the aid of CAD/CAM and CNC machinery. These methods



of design and manufacture ensure that close tolerances are maintained during fabrication. AMADAS Indus-

tries, Suffolk, Virginia, (804) 539-0231.

Machine Completely Inverts Windrows of Hay

Tebben Manufacturing's Invert-All is the first machine capable of completely inverting a narrow or wide windrow of hay. It is especially useful in very dry alfalfa (below 20 percent) without significant dry matter loss. The Invert-All has an exclusive retracting tine belt-type pickup that is also flexible laterally, enabling the pickup to follow the ground contour and pick up all of the crop. The aluminum belt has a row of teeth every 4 inches, which ensures smooth and intact crop flow. As the hay falls from the smooth belts onto the crop's conveyor, it is narrowed from 6 feet to 3 feet. Tebben Manufacturing Company Inc., Clara City, Minnesota, (612) 847-2200.

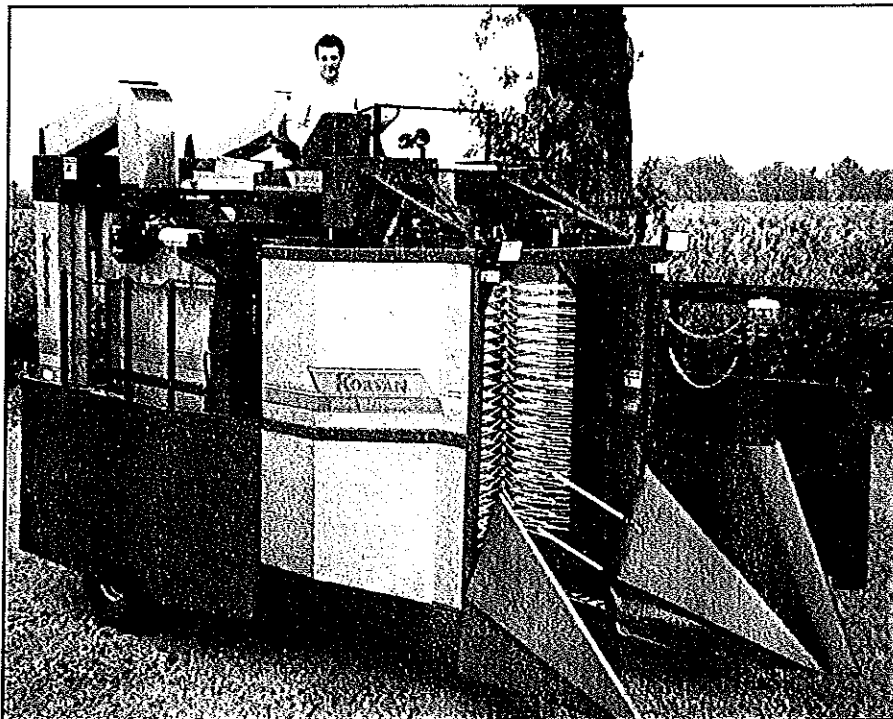
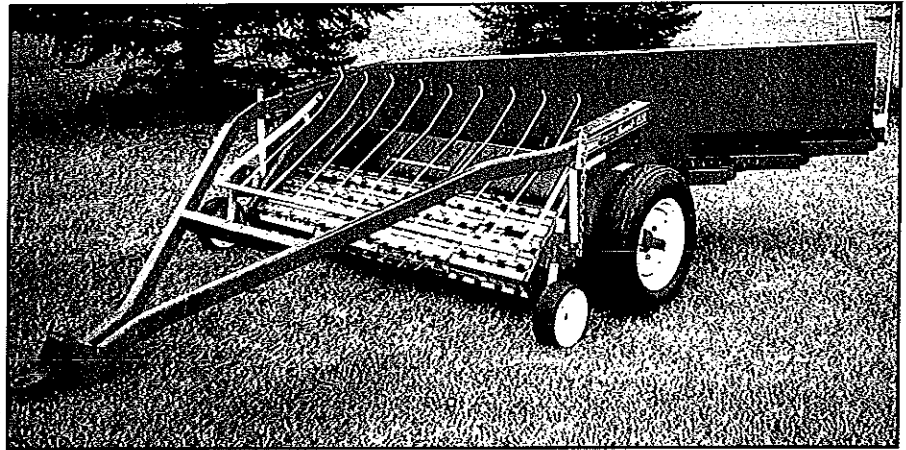

Vertical Shaking Device Consistent at High Rates

Korvan Industries' Vertirotor 9000 vertical shaking device harvests raspberry, blueberry and coffee crops using a vertical shaking drum that develops a consistent pick at 300 to 900 rpm. These free-turning picking drums provide horizontal rotation, eliminating drag and bush damage. Higher picking rates, using both a high and low range, give speeds of 0-3 mph in the field and up to 9 mph on the road. The use of large tires gives an 8 psi on soft ground and 20 psi on pavement. Korvan Industries, Inc., Lynden, Washington, (206) 354-1500.

Feed Batch Controller

Easy System's E-Z Weigh Batch Controller has an IBM compatible computer designed into the batch controller. All feeding history is saved on an internally sealed diskette for later removal and update into the farmer's accounting package. The user can run any other ration analysis or livestock accounting package directly from a feed mill screen. The feed is mixed and all data is generated automatically. The feeding plan for each group of livestock is correlated based on consumption. The unit reminds a producer to reorder feed ingredients whenever the inventory on hand drops below the reorder point for that ingredient. For commercial users, an option is available to allow for networking of a number of feed mills together with the office accounting computer. All feed mixing data will then automatically update accounting data in the office to provide for quick invoicing, inventory tracking, and customer record keeping assistance. Easy Systems Inc., Trimont, Minnesota, (507) 639-9031.

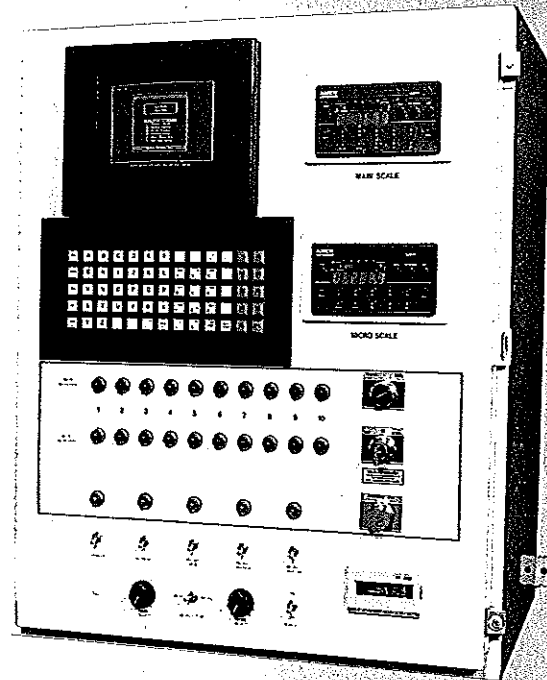

Environmental Layer House Improves Comfort

The Turbo Environmental Layer House and Turbo Air Inlet from Chore-Time Equipment provide an air-management system to improve both air and manure quality, resulting in improved bird comfort and productivity in high density layer houses. A 6-inch-wide continuous inlet row is placed directly above each cage row for fresh air intake. The air inlet is directly matched to a 6-inch-wide exhaust slot at the bottom of each cage row through which both the manure is scraped and the stale air is exhausted, improving ventilation. Manure receives a substantial amount of drying from the movement of air. Drier manure allows for a longer time to pass before the manure needs to be removed. This improved movement of air allows greater flexibility in the building of structures to house highly dense populations of fowl. **Chore-Time Equipment** Milford, Indiana, (219) 658-4101.

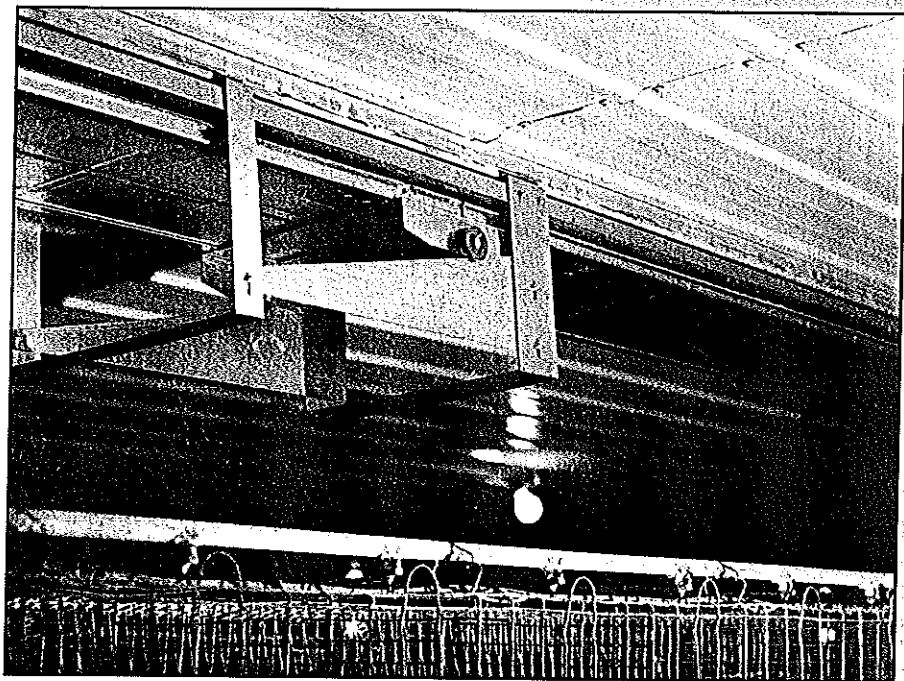

High-Rate Pump for Transfer of Food Products

ASTEC's Pump was developed for transferring, under elevated pressure to 460 psi at high rates, food products that contain particles requiring shape and size maintenance. The pump is CIPable and can be cleaned with a mechanical system. It can be fitted with a piston position sensing device to transmit electronic signals that are used for indicating-recording the output of the pump, and for controlling operations downstream that require accurate measurements. It operates across a wide range of capacities from 0-300 gpm. All operations of the pump including the opening and closing of the suction and discharge valves and the travel of the product pistons are controlled electronically. By processing and packaging products in this manner, high rates of seasonal products can be processed and packaged when the product is grown, and re-packed at a lower rate at a later time. To be sanitary and CIPable, the pump is made of stainless steel and can be fitted with a bell housing at the hydraulic cylinder end. The bell housing is fitted with a ferrule, which is attached to a manifold with valve(s) to control the flow of cleaning solution. **ASTEC**, Cedar Rapids, Iowa, (319) 395-7882.

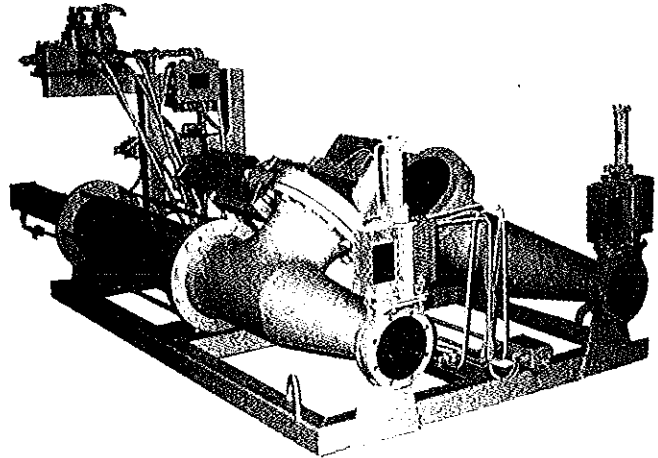

Grain Drying System Can Limit Grain Discharge

Brock's **ULTRA-DRY** Grain Drying System uses a perforated floor elevated in a standard grain

storage bin with the storage chamber being used as the drying plenum. The heart of the continuous-flow sys-

tem is the Ultraflo, which uses the Flex-Auger system, both developed by Brock. The auger is installed in a tube at the bottom of the drying chamber and is activated by a moisture-sensing unit. The auger is dragged through the tube rather than turned, which eliminates potential grain damage. The grain is actually moved only 4 inches before being dropped into the cooling storage chamber. By using the Ultraflo, it is now possible to limit the amount of grain discharged to as little as 15 to 20 bushels at a time. The moisture-sensing system installed in the Ultra-Dry gives a continuous readout and turns the discharge unit on when the correct moisture content is reached. **Brock Manufacturing**, Milford, Indiana, (219) 658-4191.

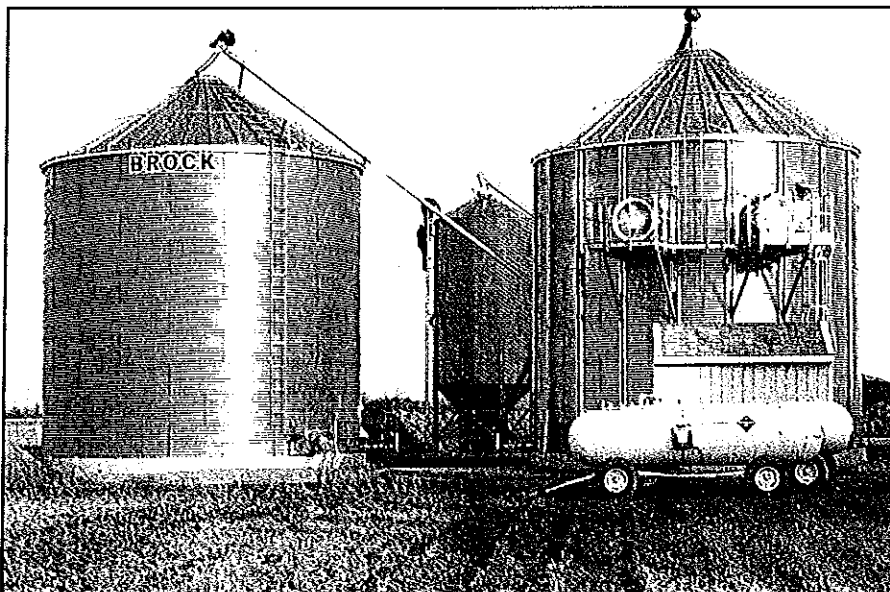

Irrigating Through a Programmable Computer

Valmont Irrigation's **C:A:M:S (Computer Aided Management System)** is a programmable computer-based control panel for mechanized pivot or corner irrigation sprinkler systems. It replaces a conventional electromechanical pivot/corner system main control assembly. It enables owners/operators of mechanized sprinklers to "enter" commands or function changes that will be accomplished without their physical presence at time of execution. Commands can be issued to water pumps, pivot systems or an auxiliary device such as a chemical injection pump. The unit has diagnostic capability that enables the operator to determine the cause of a system shutdown. It can execute automatic restart, auto stop and reverse. Valmont Irrigation, Valley, Nebraska, (402) 359-2201.

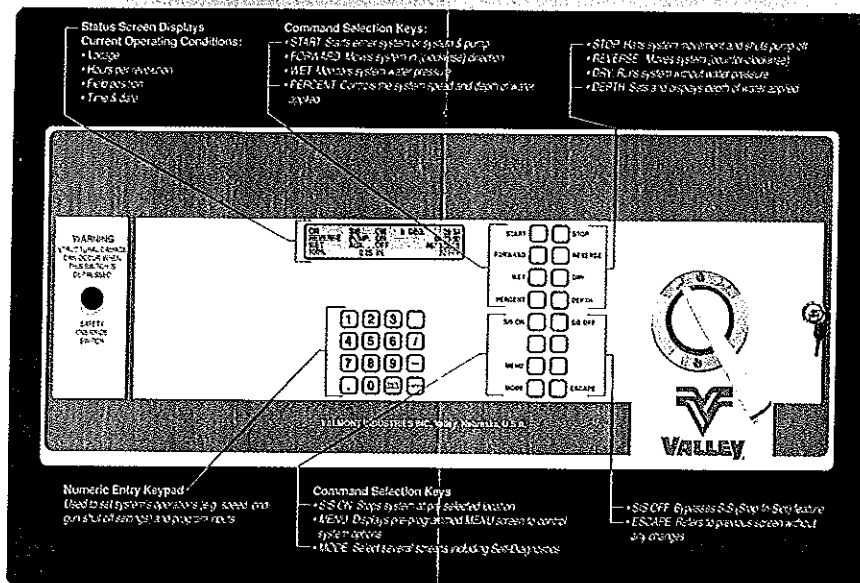

Subsurface Drip System Protects Root Intrusion

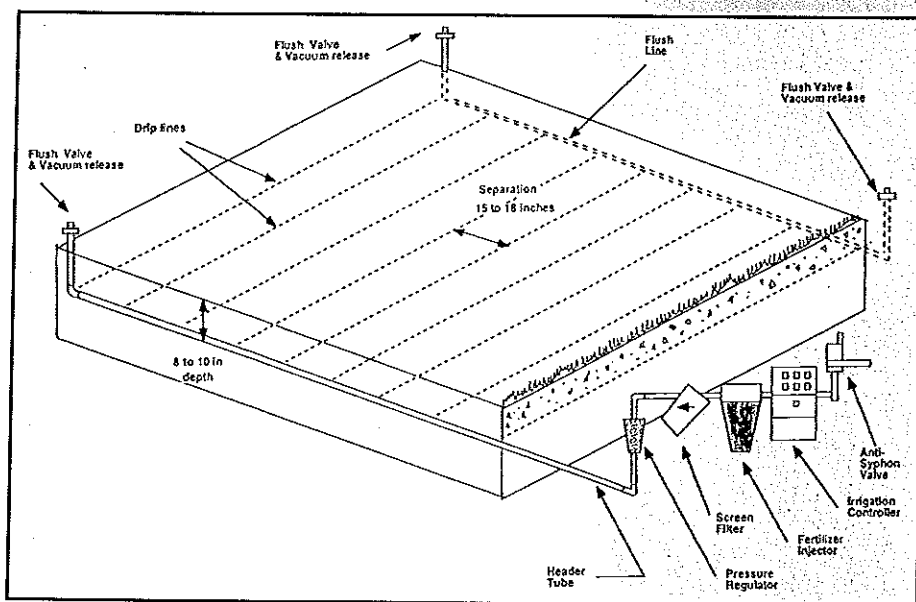

GEOFLOW Inc.'s **ROOT-GUARD** technology protects subsurface drip systems from root intrusion by slowly releasing a minute amount of herbicide into the system over a number of years. The rate of release of the herbicide is such that it can protect the emitter orifice from root intrusion for a selected number of years. The protection life is a function of the concentration of herbicide, the geometry of the emitter, the materials employed and the temperature. Mathematical models and empirical data are used to predict the protection life for a particular emitter. **GEOFLOW, Inc.**, San Francisco, California, (800) 828-3388.

Sludge and Organic Waste Spreader

Gehl Company's Heavy Duty Scavenger II Sludge and Organic Waste Spreader transports and spreads many types of organic waste from liquids to semi-solids. Truck-mounted and trailer-type units have capacities from 2,239 to 3,775 gallons. Designed for high-volume applications, they are well suited for municipalities and contract sludge haulers for their organic waste applications. For use in spreading anything from liquids to frozen materials, the Scavenger II breaks down and spreads waste material in a fine, uniform consistency acceptable for normal field coverage as well as for top dressing growing crops. The Scavenger II employs auger design and movement features to thoroughly break up and blend material, providing uniform delivery to the discharge expeller. **Gehl Company**, West Bend, Wisconsin, (414) 334-9461.

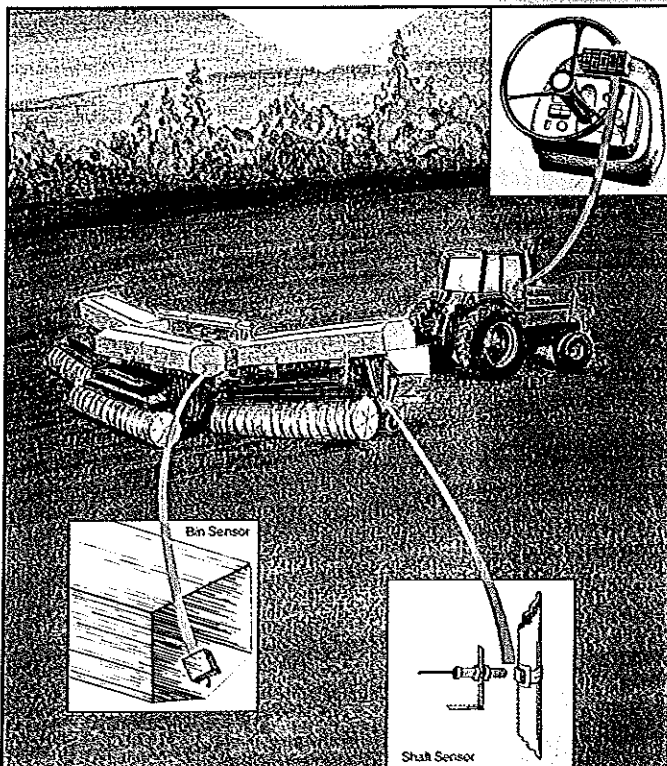
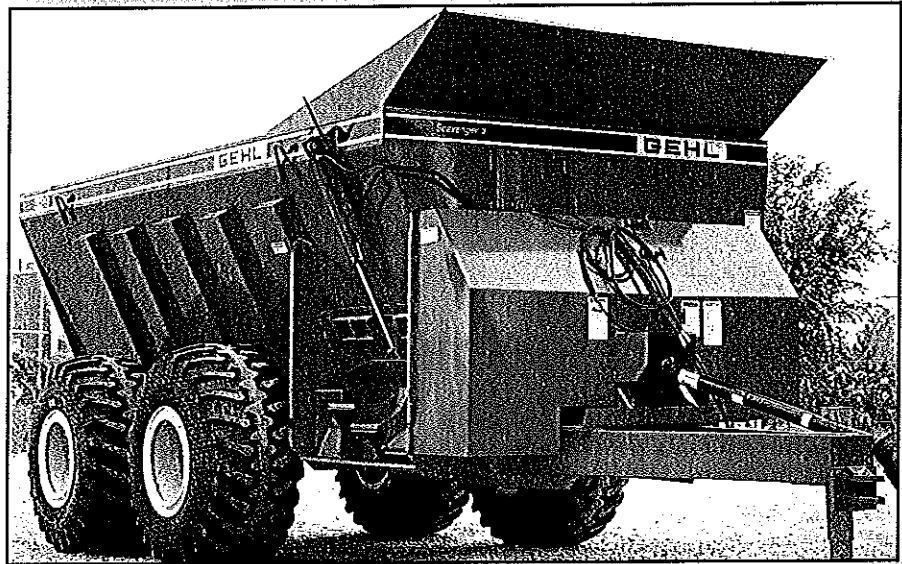

Shaft and Bin Monitor

Baker Electronic's MODALERT uses a series of interlocking monitors that are installed by the farmer or OEM manufacturer to monitor shafts and bins on farm equipment. The MODALERT system allows many types of shafts, bins or switches to be monitored from the tractor cab using affordable monitors so that the operator will be immediately warned when problems occur on the equipment. Circuit boards, case and sensors are all completely sealed. Components are firmly soldered to the circuit boards. The system, in which all the monitors interlock, can be one monitor or 100 monitors. MODALERT uses red and green lights for immediate information about equipment. Sensors are all two-conductor non-polar connections to simplify wiring. The system operates from 12VDC power for use on mobile machinery. A 110VAC to 12VDC adapter is available for stationary installations. **Baker Electronic Enterprises, Inc.**, Edmonton, Alberta, Canada, (403) 465-0107.

PTO Engagement Speed Interlock

Ford New Holland's Four-Wheel-Drive PTO Engagement Speed Interlock provides an interlock mechanism for use on an agricultural tractor to limit the engagement of the tractor PTO only when the tractor engine is running at or below a predetermined speed of operation. The interlock mechanism currently uses a mechanical lockout between the throttle control lever and the PTO engagement lever. An electronic interlock mechanism also can be used as well. Ford New Holland, Inc., New Holland, Pennsylvania, (717) 355-1121.

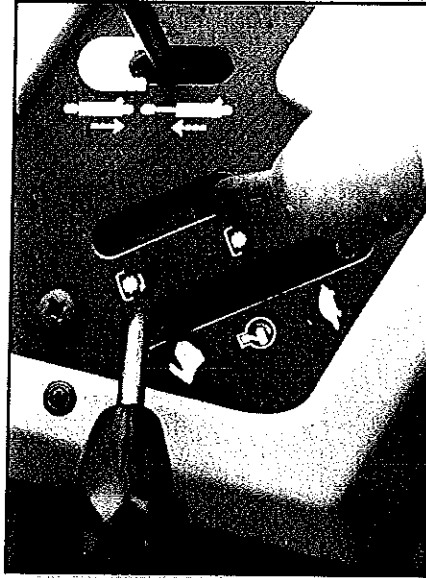

Engine Helps Maintain Speed During Harvesting

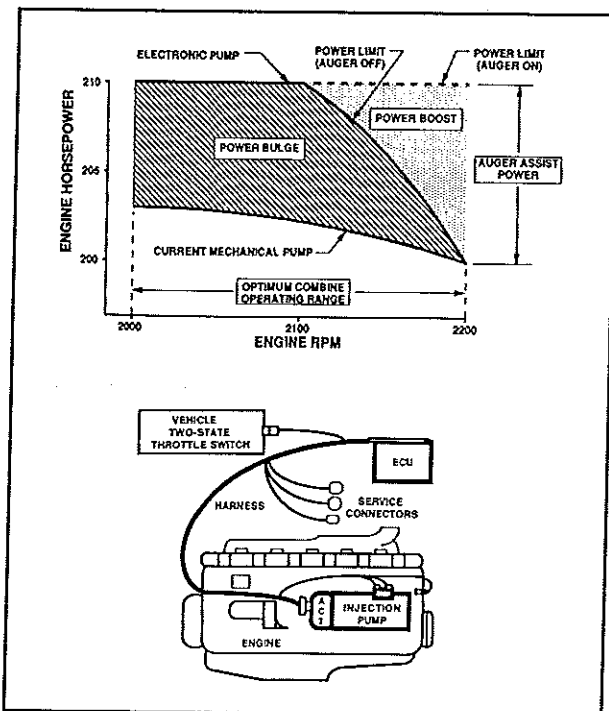

John Deere's Engine Power Bulge and Boost of the John Deere 9500 combine incorporates an electronically controlled fuel system. The system consists of an injection pump with special electronic actuator assembly, an electronic engine control unit, several special sensors, and an interconnecting wiring harness. Instantaneous and on-demand power is provided using the Deere 6076T turbocharged engine. The engine provides an additional 10 hp as it is lugged down from rated speed (2,200 rpm) to 100 rpm below rated. The extra 10 hp is available to power the auger while unloading on the go. The operator can continue to harvest without substantially reducing ground speed. John Deere Engine Group, Product Engineering Center, Waterloo, Iowa, (319) 292-8181.

Chemical Applicator Has Air-Bag Suspension

The Willmar Air Ride liquid applicator uses a four-wheel-drive independent air-bag suspension that is configured to provide self dampening. It incorporates a square tube rear frame along with a charcoal filtered and pressurized cab with curved glass to reduce noise and glare. Articulated steering — where rear wheels follow the front wheel tracks — allows for a tight turning radius. A hydraulically adjustable wheel track provides for various crop row spacings or reduces to legal width for tralling on public roads. Speeds range from 0-8 mph for poor field conditions to 0-16 mph for normal ones. Air Ride is equipped with electronic sprayer control with radar ground speed detector and indicator. In-cab features include a pressure transducer with digital readout to



monitor spray pressure, adjustable boom-height control, boom-tip control, and spray on and off control

from the driver's seat. Willmar Manufacturing, Willmar, Minnesota, (612) 235-0767.

Moisture and Weight Recording System Located on Combine

OMNIDATA International's HarvestMaster is an on-combine moisture-recording system for seed research recording of plot weight, test weight, and grain moisture on the combine. The system controls the actuators to open and close the doors of the holding hopper, weight bucket and test chamber. It sequences through the activities of grain flow control and measurement, including recording of data in memory, as well as on an auxiliary printer. Data recorded during work day can be transferred from HarvestMaster's hand-held computer to a host computer for statistical analysis. During non-harvest times, the hand-held computer can be used for taking field notes, or recording other data such as plot rating notes taken during the growing season. OMNIDATA International Inc., Logan, Utah, (801) 753-7760.



Rigid Frame Tractors Use Equal-Size Front and Rear Tires



The Case IH 9200 Series Rigid Frame Agricultural Tractors offer two models having either 235 or 300 hp. The Case IH Rigid Frame concept uses equal-size front and rear tires to maximize traction and flotation. Weight-carrying capacity allows use in heavy tillage applications. Improved wide-row crop performance, enhanced side-hill capability and improved driveability characteristics augment conventional four-wheel-drive technology. The steering functions on the units use large-capacity front and rear steering axles, and a fixed non-articulating frame. Steering modes include front steer only, rear axle steering opposite of front, rear wheels selectively steered via a rocker switch, and rear wheels only. The tractors also contain a skip shift feature to allow the driver to move through the gears at a faster rate. Case-IH, Fargo, North Dakota, (701) 293-4520.

Gestation System Provides Movable Dividers

Moorman's MoorComfort Gestation System accommodates individual sow management within typical confinement gestation facilities. The system provides the advantages of individual living spaces while permitting the sow much more freedom of movement within a minimal floor space. The sides of the containment area can be swung away by the sow to allow for a larger area for turning and moving. The new concept uses only one entrance/exit gate and a flared end on the turn-around crate. A standard farrowing crate measures 5x7 feet. The MoorComfort is 7 feet x 22 or 24 inches. With the flared end concept the unit becomes 7 feet x 44 or 48 inches at its widest. Moorman Manufacturing Company, Quincy, Illinois, (217) 222-7100.

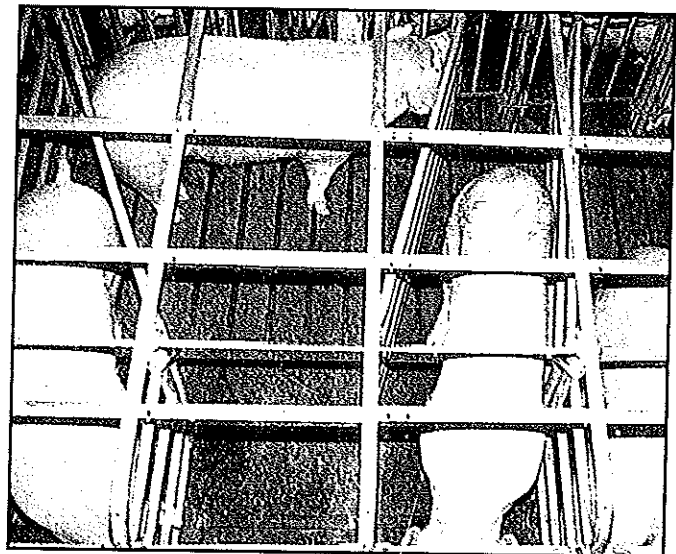

Mid-Size Combine Uses Self-Leveling Cleaning Shoe

Ford New Holland's Model TX30 Combine offers grain and maize harvesting to small- and medium-sized farmers whose land is flat or sloping. The harvester features a self-leveling cleaning system, which maintains the whole cleaning shoe in a horizontal position on either right-hand or left-hand slopes of up to 17 percent. A rotary separator, added to the threshing system, changes the speed and direction of the crop during the separation stage and provides an extra "rubbing" or separating area. The pre-cleaning and pre-blowing system consists of a controlled air blast directed at the crop as it falls

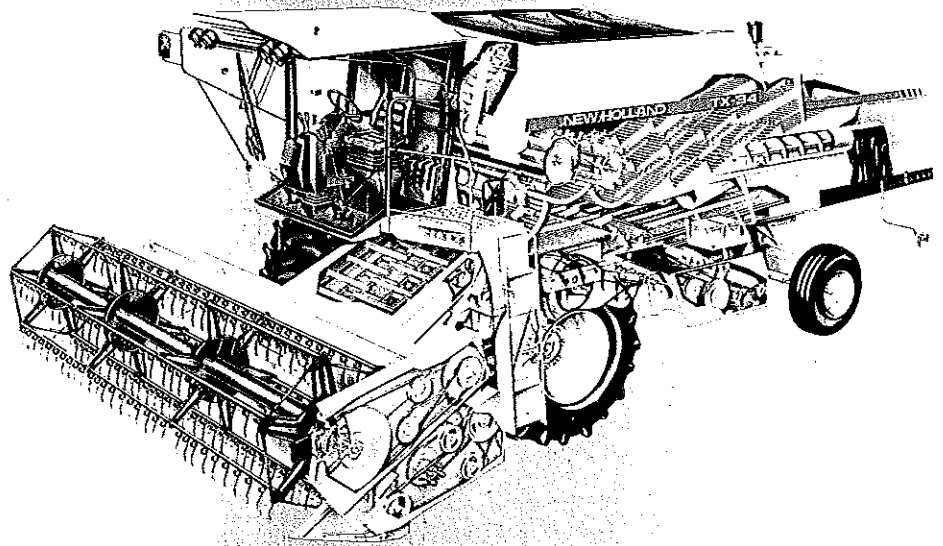

from the first to the second grain pan, plus a perforated section on the second grain pan to direct pre-cleaned grain to the bottom sieve. A "roto thresher" aggressively threshes and redistributes stubborn tailings. The

TX30 holds 136 bushels of grain and power is supplied by a 140 hp Ford 6-cylinder diesel engine. Ford New Holland, Inc., New Holland, Pennsylvania, (717) 355-1323.

Skid-Steer Loaders for Feeding, Material Handling Systems

Melroe's 50 Series Bobcat Skid-Steer Loaders handle material in both feeding and material handling systems. Equipped with the BOSS (Bobcat Operation Sensing System) on-board monitoring system, the 50 Series will shut down immediately if critical warnings are ignored by the operator. It is also helpful in maintaining the vehicle because it keeps a running record of what goes wrong on selected monitoring points. The system also aids diesel-powered loaders by monitoring the temperature and informing the operator when the engine is ready to be started. The engine can be single-side serviced because of the transversely mounted engine, made possible by a new cooling system. The two models of the series combine 1,300-pound

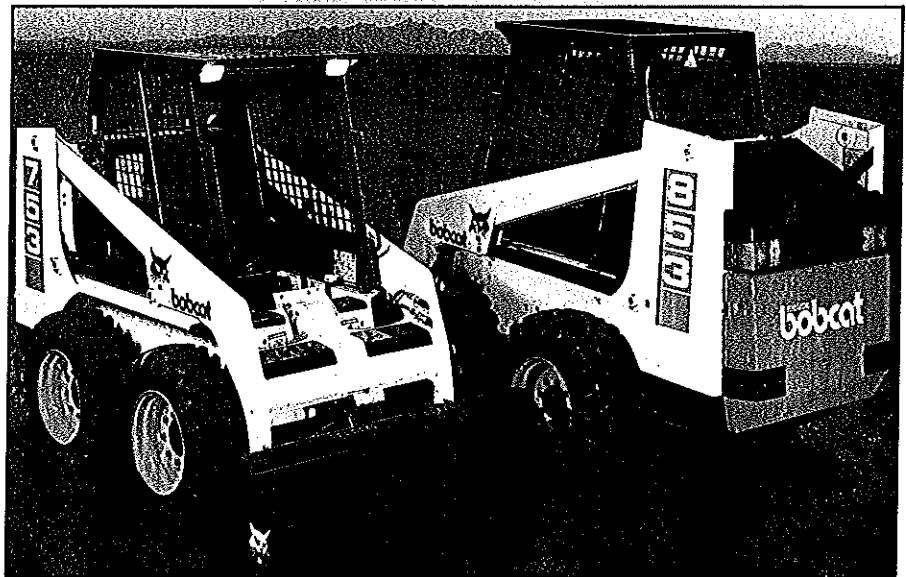

capacity with 40 hp and 1,700-pound capacity with 58 hp. Melroe

Company, Fargo, North Dakota, (701) 241-8700.

Row Crop Irrigator Provides Uniformity

Rain Bird's Rain Tape irrigates a variety of crops by metering a precise amount of water from emitters formed at various distances along a continuous thin-wall tube. The pressure-compensating tape provides emission uniformity and can be used on long irrigation runs. Rain Tape also allows for extension of its system into hilly terrain, and because of the emitter design and construction, it can be recovered and reused. A variable cross-sectional emitter path provides a "flushing" action every time the system is cycled. Rain Bird Sprinkler Manufacturing Corporation Glendora, California, (818) 963-9311.

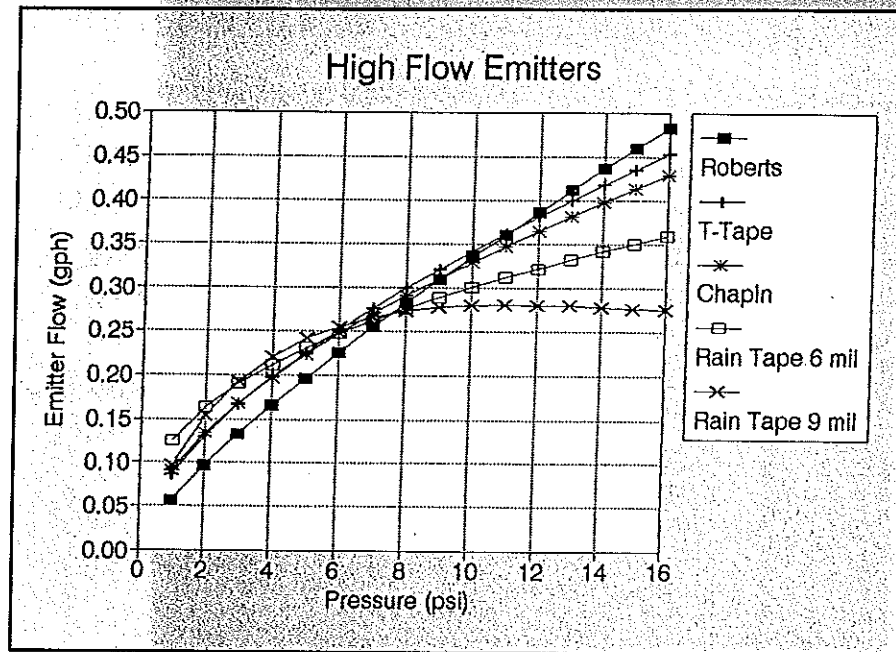

Universal Joint for Steering Systems

Weasler Engineering's Universal Joint consists of cone washers centered on a ball instead of a cross and bearing kit or a pin and block arrangement. The cone washers transmit the torque while the ball resists the axial forces. The cone washers and ball are completely sealed in a nylon housing filled with lubricant. The sealing action of the nylon housing provides lubrication for the life of the universal joint by retaining the lubricant and sealing out contamination. The compact size of the joint provides a small swing diameter to maximize clearance. Backlash or free play has been reduced to zero. Weasler Engineering, Inc., Ag Components Division, West Bend, Wisconsin, (414) 338-2161.

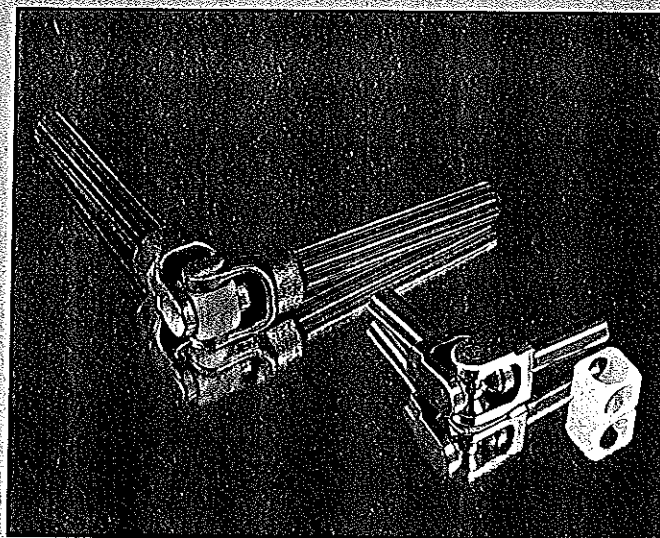

Threshing Concave Grid Insert Attaches Quickly

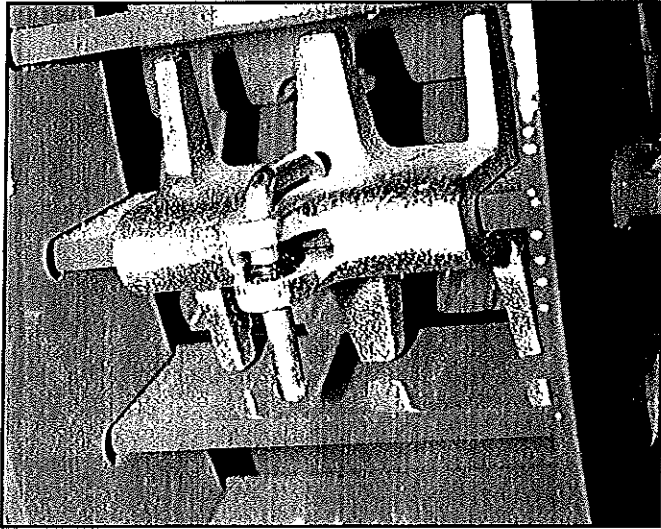

Deere and Company's **Threshing Concave Quick Attach Grid Insert** consists of a series of transversely oriented radial bars with rods passing below and through the bars in the direction of crop flow. The rods keep the crop material close to the active cylinder element so grain can be threshed, thus preventing undesirable amounts of material other than grain from falling through the gate. The inserts can be installed or removed in about 15 minutes. These inserts increase machine capacity especially in corn, since an obvious capacity increase is obtained with the inserts out. The inserts make it possible to have a courser simulated rod spacing in the rear of the concave as compared to the front of the concave, allowing better grain separation. **John Deere Harvester Works**, East Moline, Illinois, (309) 765-2200.

Panelized Cooling System Saves Space, Easy to Install

Aerotech, Inc.'s **Aerocool** 6-inch-thick cellulose panels, mounted entirely on the outside of a wall, allow for evaporative cooling with no loss of existing space, while "L"-shaped mounting flanges simplify installation. The PVC water distribution pipe is sized for the particular system to ensure even pad wetting. **Aerocool** is equipped with stainless steel bolts and wing nuts that let the operator remove the face panel on the header for inspection and easy, periodic cleaning. Using the natural cooling effect of evaporation, **Aerocool** pads can reduce inlet air temperatures by 10°F to 20°F on most days, and even more under ideal conditions. **Aerotech, Inc.** Lansing,

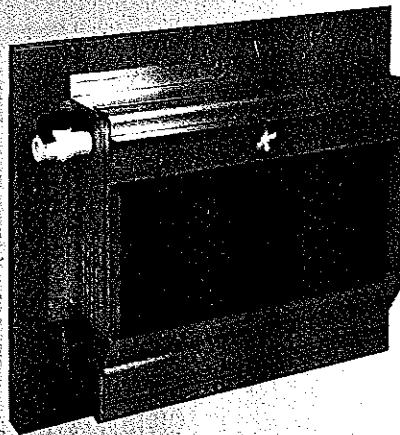

Michigan, (800)-227-AERO; in Michigan (517) 323-2930.

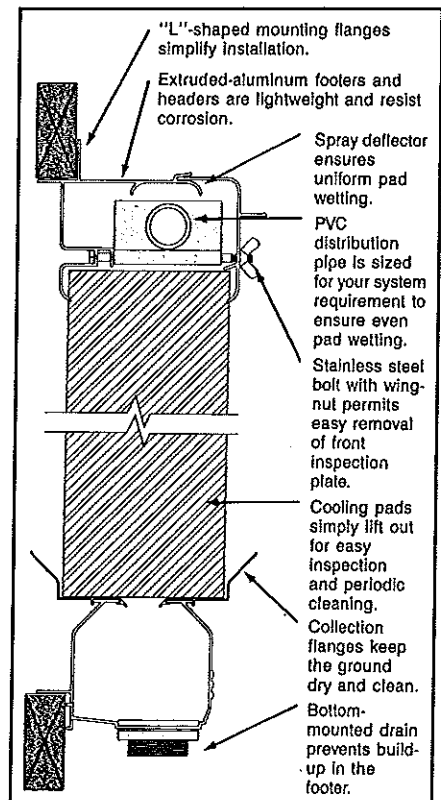

Stacker Bar with Flat-Fold Marker Enhances Safety

Orthman's 900 Series Stacker Bar with Flat-Fold Marker keeps planter row units in their normal upright position throughout the folding process, so seed, fertilizer and chemical boxes do not have to be emptied for folding or transport. This reduces the risk of chemical and seed spills. Transportability is enhanced by the 900 Series Stacker Bar. Because the row units do not hang out past the bar, the transport width is several feet narrower than a 90-degree folding bar. Using the Flat-Fold Marker with the stacker bar aids transport safety. The marker, when in the unfolded transport position is compact. Folding and unfolding takes place in three separate stages, enabling the marker to be stored, folded and unfolded inside of buildings. **Orthman Manufacturing, Inc.**, Lexington, Nebraska, (800) 658-3270; in Nebraska (308) 324-4654.

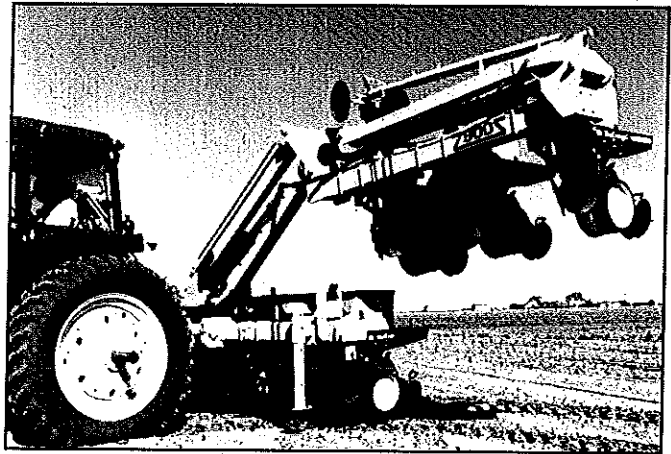

Cotton Express Pickers Designed for Minimal Daily Servicing

The J I Case 2-row 2022 and 4-row 2044 Cotton Express Pickers use completely gear-driven drums, an on-board lube system, new cotton-flow monitor, operator presence system (which stops the drums when the operator leaves the seat), and larger diameter doffers. A one-piece drum frame assembly reduces weight and provides strong support while an internal grease path allows lubing of picker bars without the flexible plastic lines on previous models. The operator presence system enhances operator safety, yet does not interfere with normal field operation or road transport. If the operator wishes to inspect the rotors as greasing occurs, the drums can be turned by operating a service bypass tether switch located in the top of one drum. **J I Case, Crop Harvesting**, Hinsdale, Illinois, (708) 887-3958.



Harvesting Head Delivers More Crop

Ford New Holland's 360N3 Three Row Forage Harvester Head for use with the model 900 forage harvester smoothly moves material away from the row units to the feed rolls via an auger regardless of the gathering chain speed. The harvester head can be used to harvest row crops with row spacing from 28 inches to 32 inches. The low-profile design with a single level of gathering chains reduces machine complexity and service. Gathering chains extend forward of the cutting discs to provide for less row sensitivity. The gathering chains deliver the crop to an auger, which then delivers the crop to the base unit. This allows the gathering chains to be run at any speed without affecting the feeding of crop into the base unit. As adjustable

bumpers pull the outside rows together, the auger has only to move the butt ends of the stalks into the feed rolls to achieve straight-line

feeding and uniform length of cut. Ford New Holland, Inc., New Holland, Pennsylvania, (717) 355-1323.

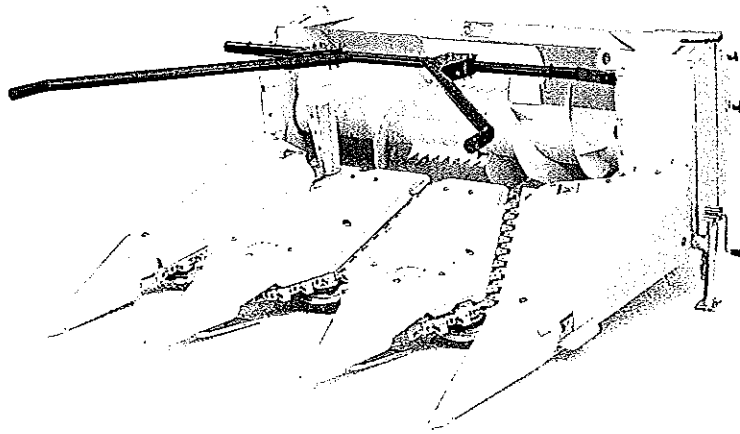

Sectional Combine Knife for Cutting Platforms

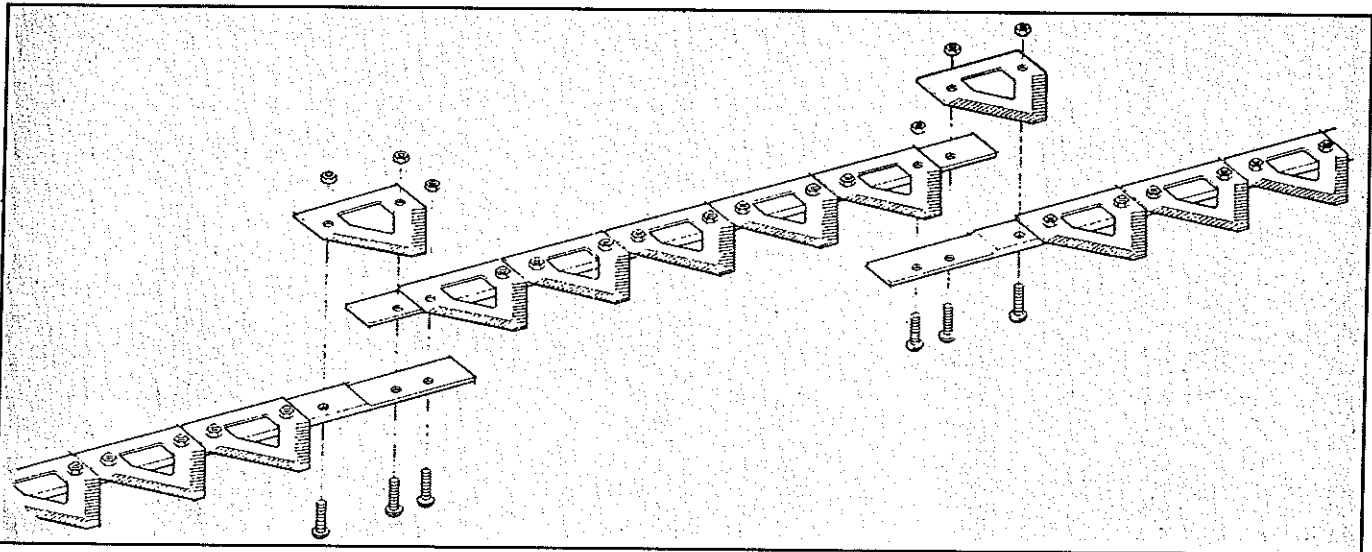

John Deere's Litening Bolt Sectional Combine Knife for 13- to 30-foot Flex and Rigid John Deere cutting platforms, eliminates the need to ship long knives by commercial haulers. It allows quick delivery of replacement knives via overnight delivery. The replacement knives can be easily transported to the work site. The sec-

tional knife also allows for replacement of only the portion that is damaged. A section can be replaced by removing only six bolts. The knives come in 10 possible lengths and have a lap joint for strong hold and fast assembly. John Deere Harvester Works, East Moline, Illinois, (309) 765-2060.

Tubular Heat Exchanger Preserves Particles

The HydroCoil from ASTEC is a special form of tubular heat exchanger where the product is in the tube and the heat transfer media (water) is on the outside of the tube. The tube may be from 0.25 inches to 4.50 inches outside diameter. Pressurized hot water is used for heating to as high as 300°F and tower or chilled water can be used for cooling to as low as 30°F to 40°F. Extremely high heat transfer rates because of internal turbulence allow the units to be used with fluid or viscous products containing particles without damage to the particles; or with extremely heat sensitive products that include milk, orange juice with or without pulp, and ice cream mix. Products successfully processed or tested with the heat exchanger include cheese sauce, puddings, chopped tomatoes in juice, yogurt fruits, toppings and apple sauce. ASTEC, Cedar Rapids, Iowa, (319) 395-7882.

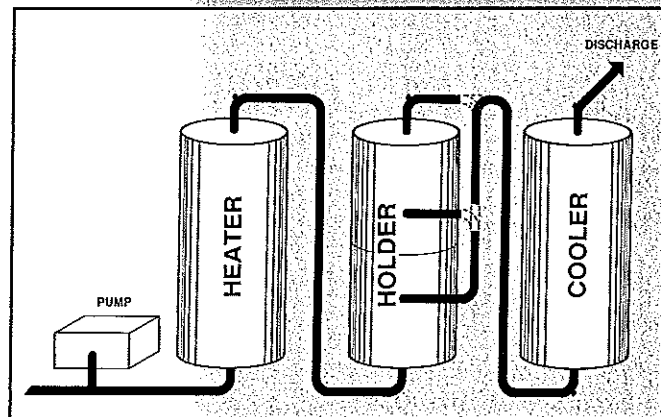

Min-Till Cultivator Provides Versatility

The Case International 184 Min-Till Cultivator, available in rigid and folding models, provides the versatility to operate in minimum tillage and can be adapted to form ridges for ridge till planting the following season. The row units are constructed heavier than conventional units for improved side stability that is necessary to handle the higher draft loads common with reduced tillage conditions. The row units also can handle large amounts of crop residues without plugging. Available from 4 row wide to 12 row narrow, the Min-Till Cultivator features heavy duty gauge wheels and an 18-inch coulters. Depth control is precise as the gauge wheel and coulters work independent of each other. J I Case, Hinsdale, Illinois, (708) 789-7146.

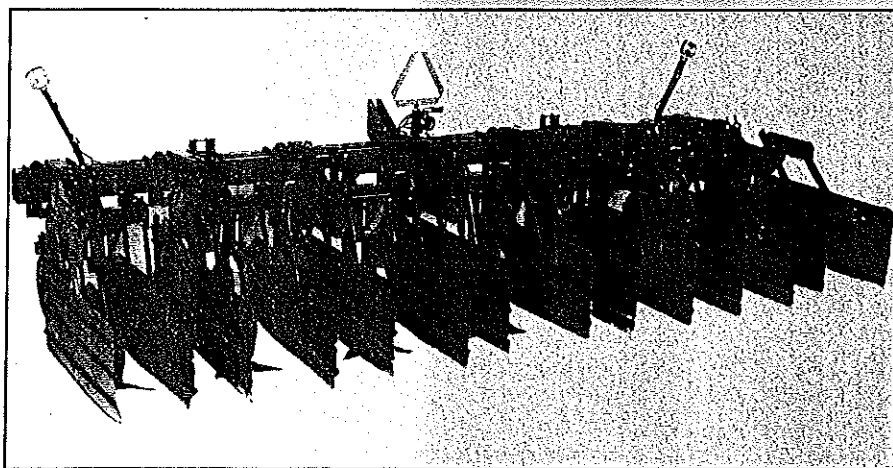

Poultry Feeder Takes Birds From Start to Finish

The Chore-Time Model C2 Feeder is designed to start day-old birds and take them to finish. Feed is delivered by a centerless core auger. With the pan lowered to the floor, the feed windows will allow feed to flow in the pan, eliminating the need for feeding by hand to start the birds. As the birds grow, the window can be locked open to allow the feeder to be raised at an earlier age. The design of the grill allows the birds to enter and exit the feed pan without being trapped. At about 10 days, the windows can be closed to allow the feed to flow out the lower feed gate for the remainder of the grow out. The C2 Feeder consists of four durable, precision-molded, rust-proof polyethylene parts. **Chore-Time Equipment**, Milford, Indiana, (219) 658-4101.

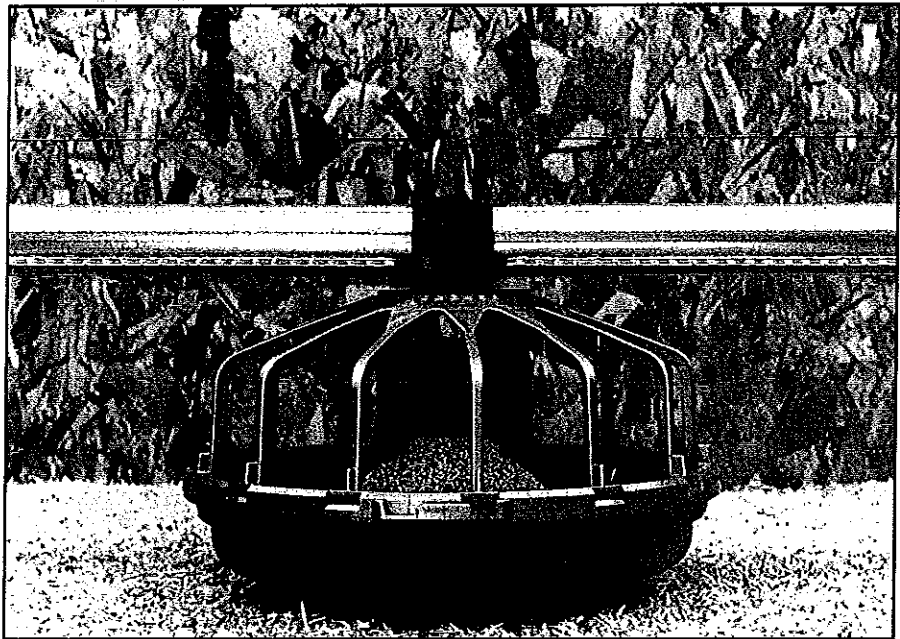

Continuous-Loop Feeding System Delivers Daily, Uniform Ration

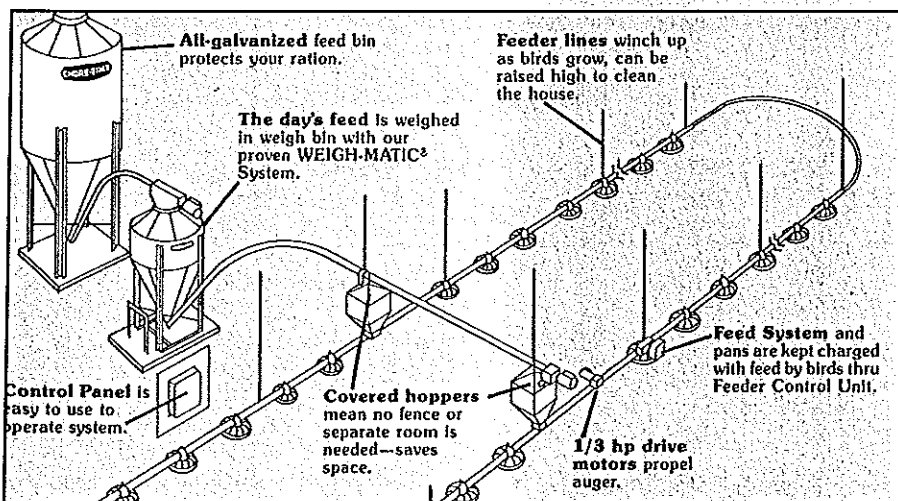

Chore-Time's UltraPan Continuous Loop Breeder Pullet Feeding System uses a closed-loop drag auger system. A uniform ration is delivered to all pans by use of the indexing of tubes and the high-speed delivery of the feed to each pan. The UltraPan provides the ability to feed every day instead of feeding every other day, eliminating undue stress to the birds on feeding day. The dragging motion of the auger does not rotate the feed as much, thus providing removal of a portion of the feed at each hole. The drive units move the auger at 100 feet per minute. A locking pan assembly ensures that feeders are not tipped up, blocking birds from eating. **Chore-Time Equipment**, Milford, Indiana, (219) 658-4101.

Wheel Attachment Provides Traction in All Soils

The DYNA-BITE System from Omitrac Corporation is a retractable wheel attachment that places steel lugs (or spades) over the drive tires to provide substantial traction in all soil conditions. Lugs are easily retractable and fold down inside the rim in a few minutes when the tractor needs to go on the road or when it is not pulling an implement. The DYNA-BITE System does not require additional weights on the drive tires to increase drawbar pull.

The effect of less weight and greater productivity produces better fuel efficiency. Even when the lugs are engaged in firm ground, the tires give the operator an air-cushioned smooth ride. Omitrac Corporation, North Chicago, Illinois, (708) 578-

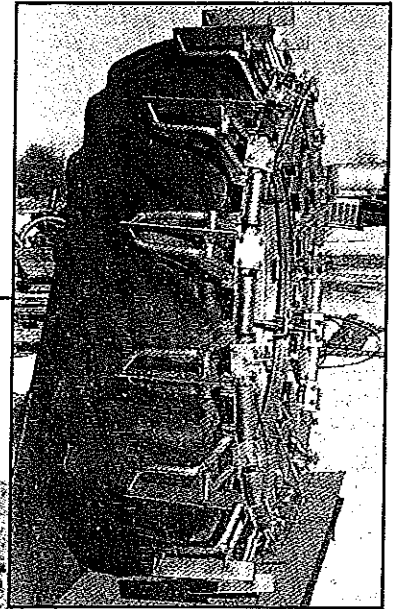

Multi-Purpose Tractor Has Turnabout Console



The Model 9030 Bidirectional Tractor from Ford New Holland is a multi-purpose utility agricultural tractor powered by a 100 PTO hp engine. It works in either direction and the Turnabout Console, which includes the seat, steering wheel and instrumentation, rotates 180 degrees in the cab to allow the operator to be always facing the direction of travel. The drive-train features hydrostatic drive coupled with a three-speed mechanical transmission to provide infinite speed selection. Power is transmitted to the ground with full four-wheel-drive and equal-size tires. The tractor can be equipped with implement hook-ups on both ends of the tractor, allowing for a wide variety of implements and attachments including doubling-up. Ford New Holland, Inc., New Holland, Pennsylvania, (717) 355-1121.

Color-Coded Spray Tips Help Eliminate Errors

The **Hardi Color Tips** are a one-piece combination of a 110-degree flat fan ceramic or synthetic nozzle locked into a color-coded snap-fit cap. They can be used on all sprayers and spraying equipment using the conventional caps and nozzles for the application of crop protection and yield enhancement chemicals. Because of their larger size, the operators have a better grip on the Color Tips when cleaning plugged nozzles, removing or handling, even when wearing protective gloves. The color code minimizes the risk of costly error in nozzle size selection and makes for ease of finding when dropped under crop canopy. **Hardi Inc.**, Davenport, Iowa, (319) 386-1730.

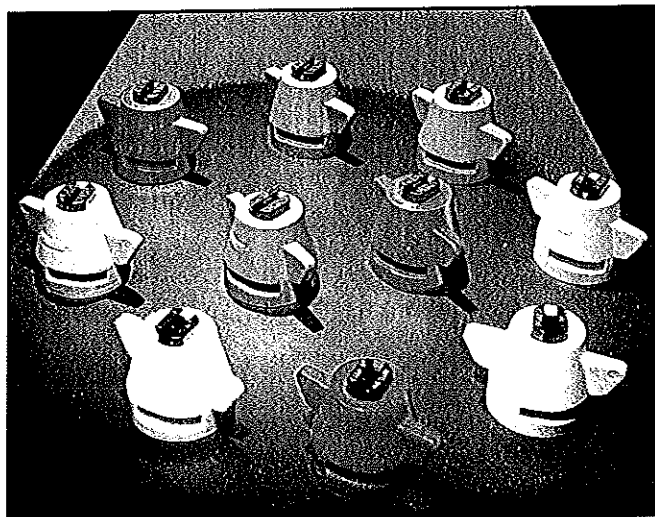

Pistachio Nut Shuttle Developed for Bulk Handling

Jackrabbit's **Pistachio Nut Shuttle** was developed specifically for bulk handling of pistachio nuts in the field. The shuttle has two operator stations, but only one operator is needed to operate it. The harvester's reservoir cart has a live floor that is driven by the harvester's hydraulic system during unloading. The shuttle is docked up to the rear of the harvester's reservoir cart, which automatically activates the live floor to load the shuttle. The load-leveling chain is activated and the indexing chain is used to facilitate loading and ease damage to the pistachio nuts. A safety feature of the two-operator station shuttle occurs when the shuttle clears a row. By using an electrical switch, the rear cab is made "live" and the forward cab "dead." Load

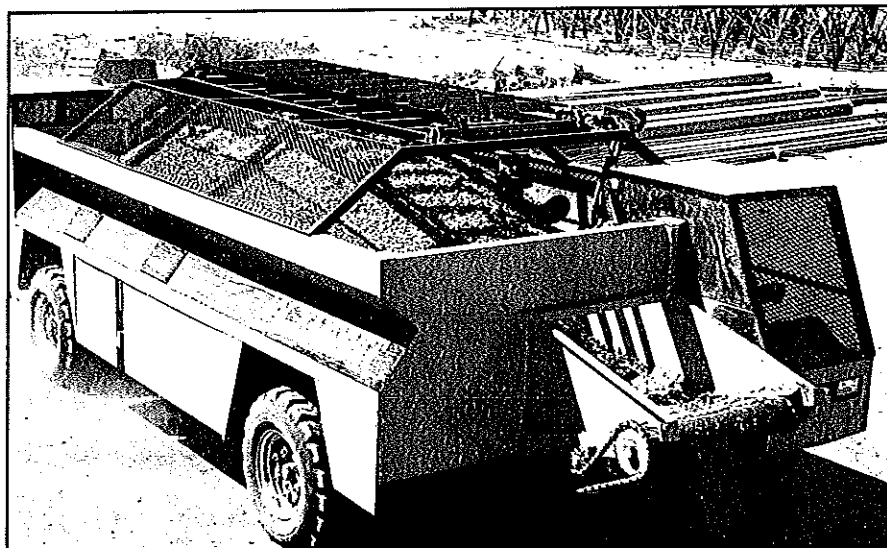

capacities of up to 10,000 pounds are carried at speeds up to 35 mph.

Jackrabbit Inc., Ripon, California, (209) 599-6118.

Precision Meter Has One Moving Part

The Kinze Brush-Type Seed Meter is designed for metering soybeans, milo/grain sorghum or cotton. The meter consists of a die-cast aluminum housing and a system of brushes that fills and retains individual seeds in a precision-molded seed disc with specially designed seed pockets. As the disc rotates vertically within the housing, seeds gravitate toward the perimeter of the seed disc. Individual seeds are then picked up by the molded seed pocket and retained by the special brush system until they reach a point immediately above the seed tube where they are released and allowed to drop into the seed trench. **Kinze Manufacturing, Inc.**, Williamsburg, Iowa, (319) 668-1300.

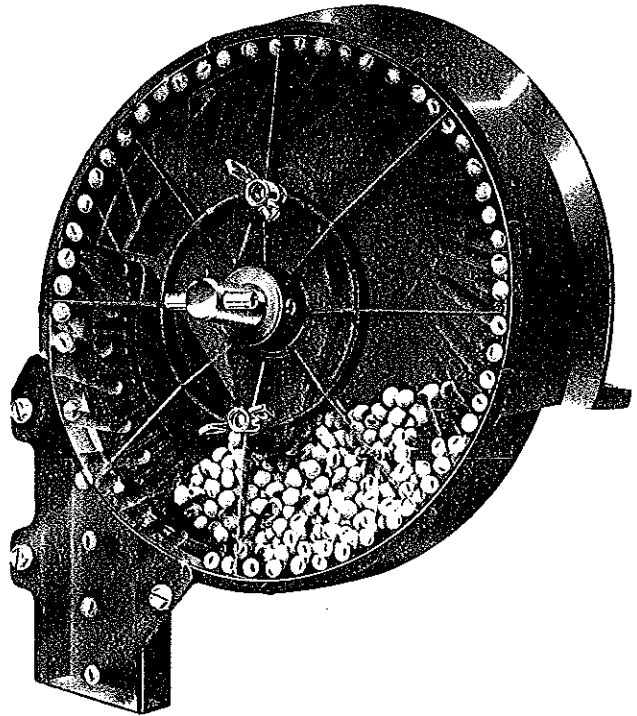

Motor Driven Injector Pump to Save Oil Supplies

The Oil-Rite Motor Driven PurgeX Meter will help preserve oil supplies and aid in preventing pollution. This metering system can be used with a wide range of liquids or chemicals that demand critical flow control. The meter can be minutely adjusted to specific output requirements. It is electrically driven from an appropriate switch timer or computer and requires no other external energy source and can be mounted in any position. Settings are so exact that it is possible to take 4 ounces of liquid and continuously meter it over several years. The meter is constructed of lightweight aluminum with brass and steel components for long life. Buna N and viton seals are used throughout for positive sealing, with other seal materials available. The small gear motors for driving the pump are available in various configurations, including servo motors. All common AC and DC voltages are available. **Oil-Rite Corporation**, Manitowoc, Wisconsin, (414) 682-6173.

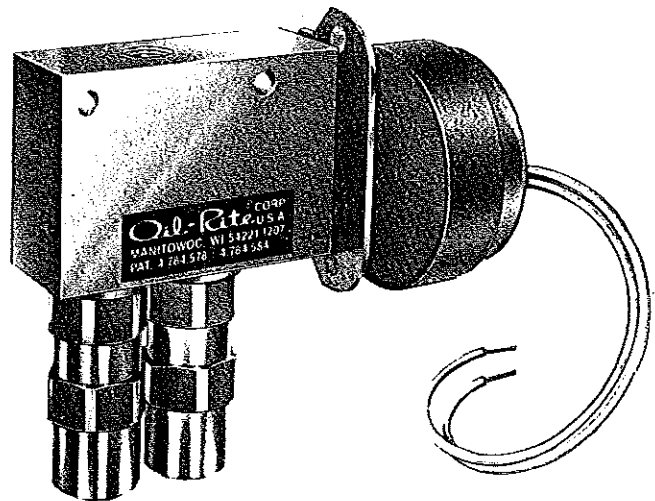

Bale Monitor for Large, Round Bales

The Vermeer Equal-Fill Bale Monitor is for use on large, round hay balers to indicate to the operator when to weave across the windrow of material such that a level or "square" bale is formed rather than barrel- or conical-shaped bales. The monitor has two integral parts: a timer adjustable from 5 to 25 seconds that resets itself after each countdown and signals to the operator which way to drive by means of both a light and buzzer, and a magnetic reed switch attached to the windguard that works in cooperation with the timer. As long as the windguard is in its lower position, the magnetic switch interrupts the timer countdown and puts it on hold. As hay enters the baler, the windrow lifts the windguard out of the magnetic switch and the timer either begins or continues its countdown. When the countdown is complete, a buzzer sounds and a light indicates to the operator which way to drive. The system regulates equal portions of material into each side of the baler. Vermeer Manufacturing Company, Pella, Iowa, (515) 628-3141.



Fiber Ideal for Coating, Binding and Thickening

Weyerhaeuser Company has developed Cellulon Fiber, a reticulated bacterial cellulose from corn syrup derived glucose that is able to behave uniquely as a functional ingredient in binding, thickening and coating applications. The fine fibers of Cellulon can hold water through enhanced hydrogen bonding, bind to other hydrophilic surfaces, thicken formulations, and provide enhanced strength at low levels of incorporation to films and composites. Cellulon fiber is a natural product with no added materials or compounds. The product fits well into industries such as foods, cosmetics and plastics production where natural products are being required. Weyerhaeuser Company, Tacoma, Washington, (206) 924-6547.

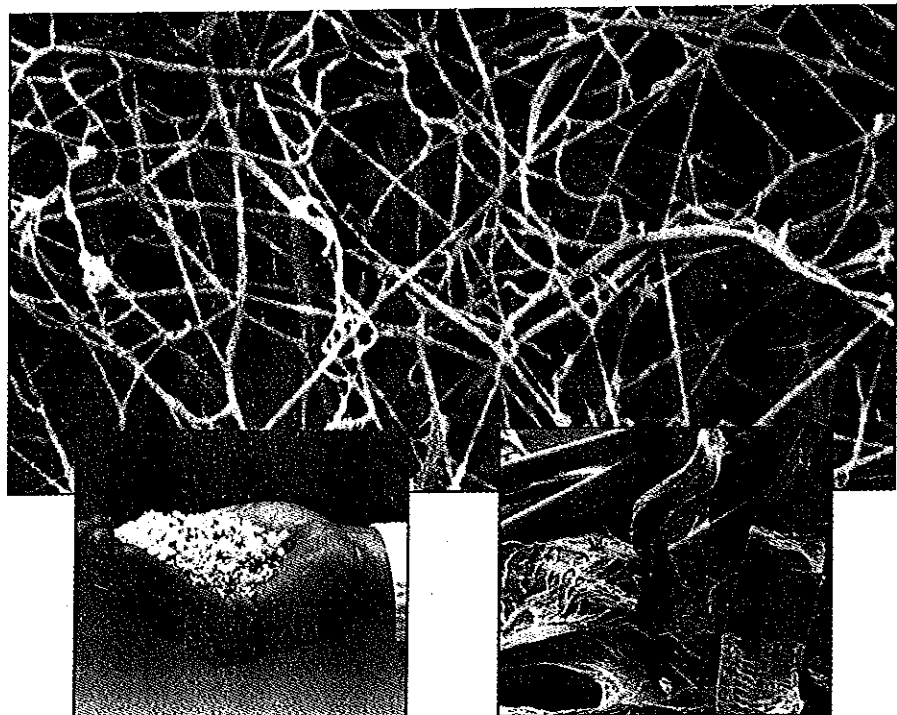

Stainless Steel Sprinkler Features Smooth Flow

Rain Bird's Ssteelhead Stainless Steel Impact Sprinkler features a laminar flow water passage for smooth, tubular water passage that creates less friction and turbulence; Quick Fit nozzles with easy quarter-turn removal for cleaning while sprinkler is operating; positive impact drive for maximum distance of throw and greater resistance to clogging; choice of straight bore or low pressure nozzles; "H" bearing of Delrin plastic that resists grit and provides longer bearing life; and choice of four body trajectory angles. Various applications for the Ssteelhead include irrigation in banana plantations and tree orchards, and frost protection in tree orchards. Rain Bird Sprinkler Manufacturing Corporation, Glendora, California, (818) 963-9311.

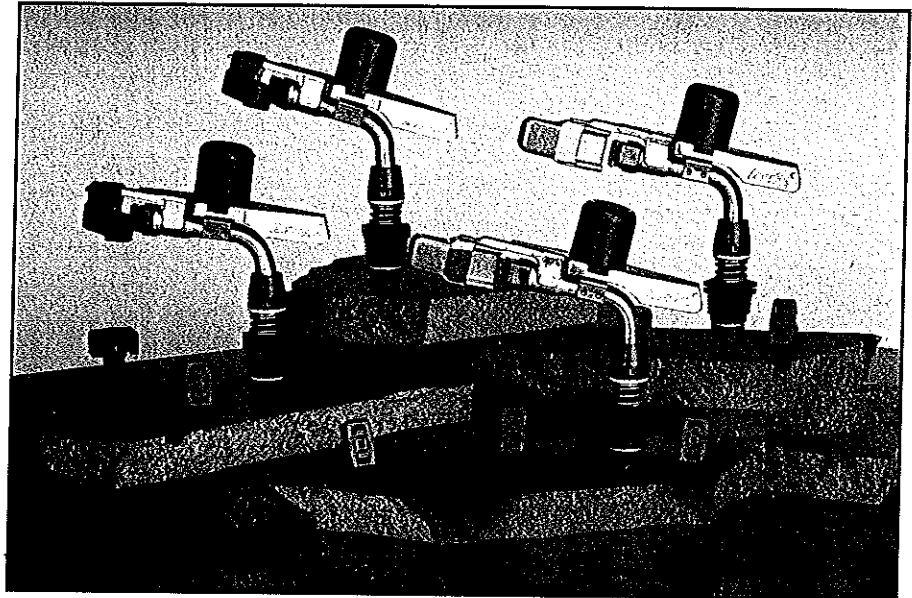

Closed-Handling System for Planter Applied Granular Pesticides Helps Ensure Operator Safety

The LOCK 'n LOAD closed-handling system for COUNTER systemic insecticide-nematicide is a system developed in a cooperative effort by Deere & Company and American Cyanamid Company. The system consists of a special COUNTER package with a built-in dispensing valve, and a special hopper lid and receiving valve assembly that fits John Deere Max-Emerge and MaxEmerge2 planters. When the two valves are coupled, they open automatically to provide a path through which the pesticide can flow from the package to the planter's hopper. When the valves are uncoupled, they close automatically. Because there are no open bags with the system, the chance of pesticide dust blowing onto field personnel or equipment is minimized. An over-center latch was adopted to fasten the rear of the closed handling lid to the pesticide hopper. This provides easier serviceability and end-of-season cleanout, because no tools are required to remove the lid. John Deere Harvester Works, East Moline, Illinois, (309) 765-2019, and American Cyanamid Company, Wayne, New Jersey, (800) 942-0500.

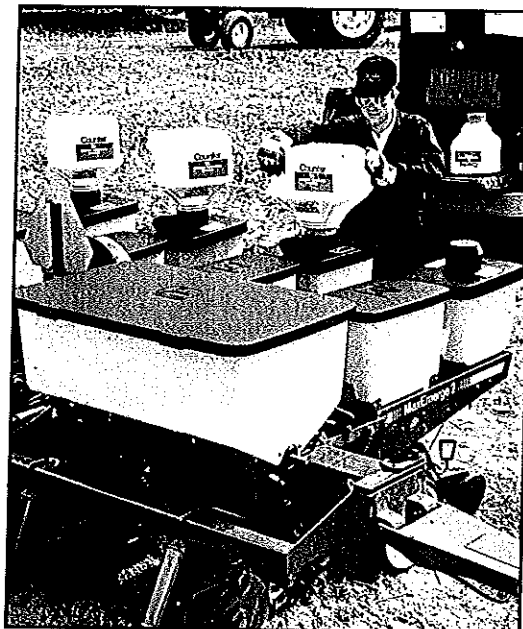

Aerotech, Inc.

Aerocool Extruded Aluminum Evaporative Cooling System
Page 17

AMADAS Industries

Magnum Fource Four- and Six-Row Peanut Combines
Page 6

American Cyanamid Company

LOCK 'n LOAD Closed Handling System for Planter Applied Granular Pesticides*
Page 26

ASTECC

ASTECC Pump — High Capacity Transfer System for Slurry Type Materials
Page 9

ASTECC

HydroCoil Tubular Heat Exchanger
Page 20

Baker Electronic Enterprises Inc.

MODALERT — Shaft and Bin Monitor
Page 11

Brock Manufacturing

ULTRA-DRY — Grain Drying System
Page 9

Case-IH

9200 Series Rigid Frame Agricultural Tractors
Page 14

J I Case

184 Min-Till Cultivator
Page 20

J I Case/Crop Harvesting

Cotton Express Pickers — Models 2022 and 2044
Page 18

Chore-Time Equipment

Model C2 Feeder
Page 21

Chore-Time Equipment

Turbo Environmental Layer House and Turbo Air Inlet
Page 8

Chore-Time Equipment

Ultrapan — Continuous Loop Breeder Pullet Feeding System
Page 21

David Manufacturing Company

Combine Calc-U-Dri — Automatic Moisture Controller
Page 5

John Deere Des Moines Works

9960 MVP Cotton Picker
Page 6

**John Deere Engine Group,
Product Engineering Center**

Engine Power Bulge and Boost Features on John Deere 9500 Combine
Page 12

John Deere Harvester Works

Litening Bolt Section Combine Knife
Page 19

John Deere Harvester Works

LOCK 'n LOAD Closed Handling System for Planter Applied Granular Pesticides*
Page 26

John Deere Harvester Works

Threshing Concave Quick Attach Grid Insert
Page 17

Easy Systems, Inc.

E-Z Weigh Batch Controller
Page 8

FMC Corporation,

Agricultural Machinery Division

Crop Care System — Computer Controlled Sprayer Control System
Page 4

Ford New Holland, Inc.

Four-Wheel-Drive Tractor PTO Engagement Speed Interlock
Page 12

Ford New Holland, Inc.

TX-30 Mid-Size Combine
Page 15

Ford New Holland, Inc.

360N3 Three-Row Forage Harvester Head
Page 19

Ford New Holland, Inc.

9030 Bidirectional Tractor
Page 22

Gehl Company

Heavy Duty Scavenger II Sludge and Organic Waste Spreader
Page 11

Geofflow, Inc.

ROOTGUARD Subsurface Drip Irrigation System
Page 10

Hardi Inc.

Color Tips — Nozzle and Snap-Fit Cap-In-One
Page 23

Hardi Inc.

TWIN SYSTEM Trailer Sprayer
Page 4

Jackrabbit Inc.

Pistachio Nut Shuttle
Page 23

Kinze Manufacturing, Inc.

Brush-Type Seed Meter
Page 24

Korvan Industries, Inc.

Vertrotor 9000 Vertical Shaking Device
Page 7

Melroe Company

50 Series Bobcat Skid-Steer Loaders
Page 15

**Moorman Manufacturing Company,
Livestock Equipment Division**

MoorComfort Gestation System
Page 14

Oil-Rite Corporation

Motor Driven PurgeX Metering System
Page 24

Omnidata International Inc.

HarvestMaster — On-Combine Weight and Moisture Recording System
Page 13

Omitrac Corporation

DYNA-BITE Retractable Wheel Attachment
Page 22

Orthman Manufacturing, Inc.

900 Series Stacker Bar with Flat-Fold Marker
Page 18

**Rain Bird Sprinkler Manufacturing
Corporation**

Rain Tape Row Crop Irrigator
Page 16

**Rain Bird Sprinkler Manufacturing
Corporation**

Ssteelhead Stainless Steel Impact Sprinkler
Page 26

Sukup Manufacturing Company

Bug Beater — Insect Vacuum
Page 5

Tebben Manufacturing Company Inc.

Invert-ALL — Inverter for Windrowed Crops
Page 7

Valmont Irrigation

C:A:M:S — Computer-Aided Management System for Mechanized Pivot or Corner Irrigation Sprinkler Systems
Page 10

**Vermeer Manufacturing Company,
Ag/Tree Division**

Equal-Fill Bale Monitor
Page 25

**Weasler Engineering, Inc.,
Ag Components Division**

Cone Washer Steering Joint
Page 16

Weyerhaeuser Company

Cellulose Fiber — Bacterial Cellulose Fiber
Page 25

Willmar Manufacturing

Air Ride — Air-Bag Suspension System
Page 13

*Joint development