

**Agricultural
Engineering®**

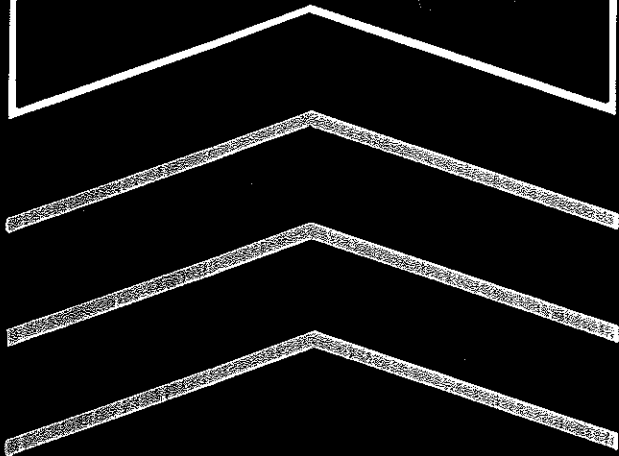

50

**OUTSTANDING
INNOVATIONS
1989**



Paying Tribute to the AE 50

It is most definitely an honor for a new or enhanced agricultural product to find acceptance in the marketplace. But for innovative products and systems to be named among the winners of the annual Agricultural Engineering 50 award is to be held in high esteem by one's peers — designers, developers, managers, and others actively involved in the field of agricultural engineering.

Showcased in this special section are "outstanding innovations in product or systems technology," developments introduced into the market in 1988. "Developments that embody the application of new technology or the innovative application of an older technology" were eligible for submission by any company supplying components, manufacturing products, or developing systems for food and agriculture.

A distinguished panel of judges — engineering experts from a number of well-known organizations — thoughtfully reviewed each of the entries for the purpose of identifying those with the greatest potential for making "worthwhile contributions to the advancement of engineering technology in food and agriculture."

Agricultural Engineering magazine is proud to play a pivotal role in bringing into the spotlight these very significant developments in the research, production, processing, packaging, storage, and transportation of agricultural products. They hold great promise for helping farmers, processors, researchers, and equipment manufacturers to reduce costs, improve quality, enhance nutritional values, strengthen their competitiveness, and boost profitability. To all of the firms — and especially to the individuals involved in the conception, design, and development of these 1989 AE 50 award-winning products and systems — we salute you.



Versatile Material Handling Attachment

The **QUAD-FLEX** grapple attachment is designed as an improved bulk material handling attachment for agricultural and industrial off-road vehicles. Various models may be front-mounted on skid steer loaders, tractors, all-terrain forklifts, and articulated wheel loaders. Currently used in applications such as bulk feed handling, agriculture by-products, general maintenance and clean-up, and waste handling, the attachment will also be employed in land management programs to perform tree and brush clean-up and to clear rocks from planting sites. It consists of four rigid steel-jaw weldments joined together at three separate pivot points. The opening and closing movements are powered by electric-actuated hydraulic cylinders which the operator controls with thumb switches. The **QUAD-FLEX** is versatile enough to move a variety of loads without changing from a bucket to a



conventional-type grapple. The flex-action see through the steel ribs of the jaw works much like the human hand to weldments for ease in loading and conform to sizes and shapes of different unloading. **Full Vision, Inc.**, Newton, KS materials. Its design allows the operator to (316) 382-3344.



Herbicide Handling System Reduces Human Exposure

Optional dripless nozzle eliminates leakage.



The **Farm-Pak CS** (chemical system) provides a closed herbicide handling system that eliminates the need for pouring 2.5-gal (9.5 L) jugs and reduces the risk of leaks and spills. It is a dedicated system for **Dual[®]** and **Bicep[®]**, which are available in refillable units that meet **MACA-75** (Midwestern Agricultural Chemical Association) standards for mini-bulk containers. The system consists of a tank, pump, hose, meter, ball valve, and nozzle. A **GPI** piston pump delivers 7 to 8 gal/min (26 to 30 L/min) of viscous pesticides, even at temperatures of 40°F (4°C). Recirculation occurs automatically when the pump is activated. The **GPI** electronic digital meter provides accurate metering for correct mix rates, and features a digital display that shows the gallons pumped to within $\pm 0.50\%$. A safe coupler system features self-locking, dripless couplers at critical connection points throughout the system, which prevent herbicide loss and contamination. The **Farm-Pak CS** eliminates improper disposal of rinsate and empty jugs, helping to keep ground-water supplies safe. **CIBA-GEIGY Agricultural Division**, Greensboro, NC (919) 292-7100.

Advanced Forage Harvester

Automatic knife sharpening and shearbar setting are part of a highly sophisticated **Accucut (Adjust-O-Matic** in the European market) system of self-propelled forage harvesters. Microprocessor and electrical controls allow for optimum shearbar-to-cutterhead knife clearance without the need for operator intervention. The system incorporates an automotive knock sensor to detect impact noise generated by shearbar-to-cutterhead knife contact. An auxiliary signal source injects impact noise periodically, providing a closed-loop, self-test of the knock sensor. Adaptive techniques provide the capability to detect impact noise in the presence of variable machine noise, resulting in increased cutting efficiency, low fuel consumption, and reduced machine wear. Functions that can be diagnosed include: sharpening RPM, sharpening motor, sharpening adjust stone, adjusting RPM, adjusting motor, adjusting knives, and adjusting sensor. **Ford New Holland, Inc.**, New Holland, PA (717) 355-1319.

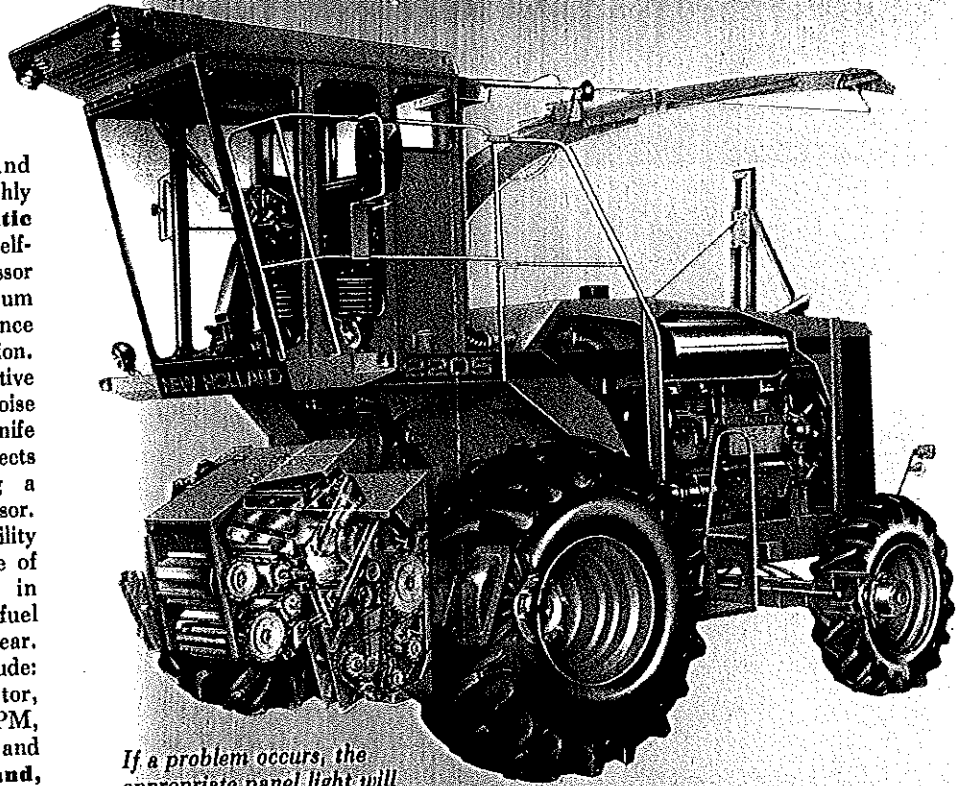

If a problem occurs, the appropriate panel light will illuminate and a warning buzzer will sound.



'Stress-Less' Feeder Increases Egg Production

The **Ultraflo** breeder feeder utilizes an auger driven by a hardened steel sprocket through an open trough to deliver feed to adult females quickly and with less stress. The centerless-core auger travels through the trough and elbows, making turns at the ends of the loop. It slowly turns, continuously remixing the feed. The trough uses a connector to join and lock the end of the trough together. A wire grill blocks males and maintains trough-eating space for females. Because the system fills troughs at an auger speed of 100 ft/min (30 m/min) and allows all birds to eat simultaneously, there is less competition and stress, better performance, and less picking over feed. The feeder uses as many as four 1/3-hp (0.25 kW) power units per loop for houses up to 600 ft (183 m), with a maximum of 2-2/3 hp (2 kW). The system promotes better and more uniform bird weight, resulting in a better lay and increased production of chicks. **Chore-Time Equipment**, Milford, IN (219) 658-4101.

Energy-Efficient Automated Roll Mill Grinder

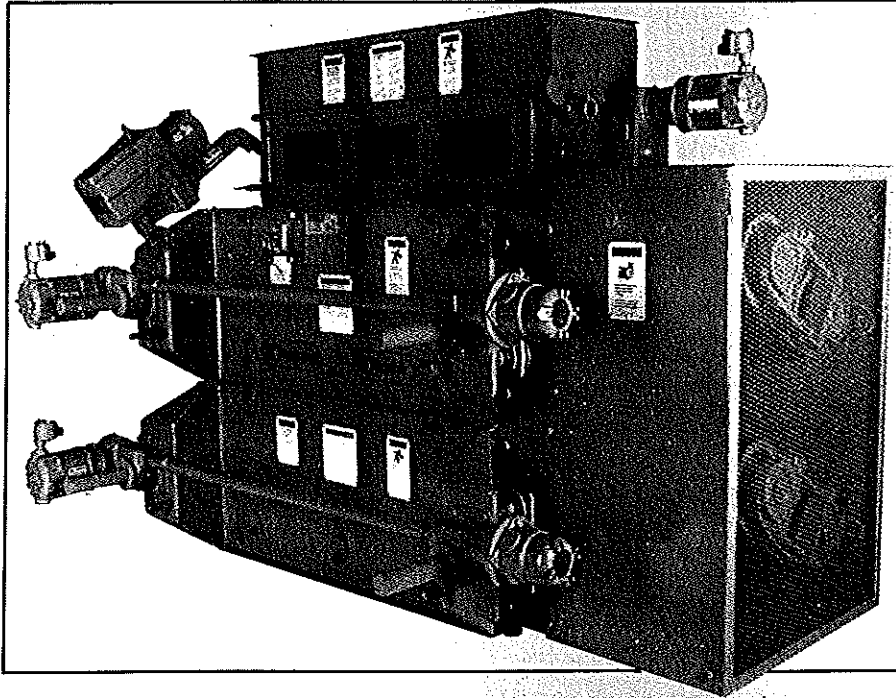

A unique bearing-block construction roller mill allows for automation and digital readout roll gap and assures tram control and parallelism of rolls. This modular **Model 1200 Roll Mill Grinder** handles up to 200 hp (140 kW) for enhanced production efficiency, and provides increased control of particle size with less shrinkage due to moisture and dust loss. Optical encoders track roll gap settings and straight line roll movement permits control to 0.001 in. (0.0254 mm). Machine jack screws are used for roll adjustment and provide accurate, repeatable gap adjustment. The linear actuator on the feed gate allows for remote/automatic feed rate control and motor load control. Shaft-mounted gearbox maintains positive roll speed differential up to 100 hp (75 kW) per pair. This roller mill promises energy savings of 30 to 50%, lower noise levels and less frequent maintenance than traditional equipment, and reduced risk of fires and/or explosion. **Roskamp Division, California Pellet Mill Co., Waterloo IA (319) 232-8444.**

Custom-Built Transmission Adds Design Efficiency

The **Series 40 M35 Hydrostatic Transmission** product line is a complete family of medium-duty, axial-piston, closed-circuit hydraulic units. It includes a variable displacement pump, variable displacement tandem pump, fixed displacement motor, and variable displacement motor, each of which can be applied separately or combined in a system to transfer and control power. When combined in such a system, these units provide an infinitely variable speed range between zero and maximum, in both forward and reverse modes of operation. The modular design of each unit makes it possible to create a wide range of model features using a basic parts list and changing only a few parts per model. This flexibility allows equipment manufacturers to inventory a base unit model and produce machine variations to order by simply performing an on-the-build-floor conversion using the appropriate M35 option modules. Base units feature a parallel axial piston/slipper design, 2.1 in.³ (35 cc) maximum displacement, 3600 rpm

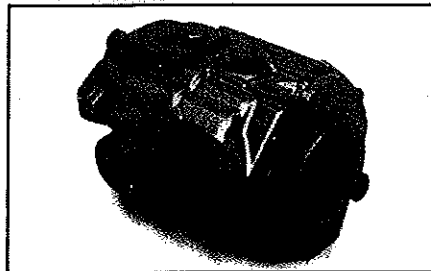

Variable Displacement Pump

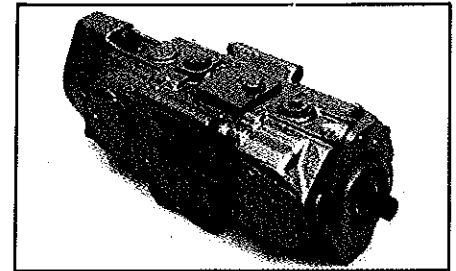

Variable Displacement Tandem Pump



Fixed Displacement Motor

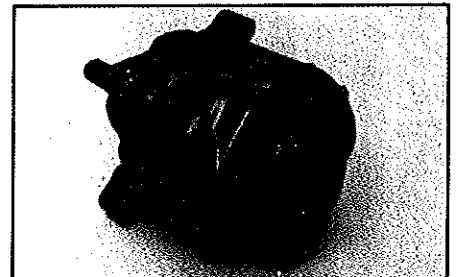

Variable Displacement Motor

continuous speed rating with intermittent speeds to 4500 rpm, 3000 psi (21 000 kPa) continuous pressure rating, 5000 psi (34 500 kPa) maximum pressure, and a 119 hp (89 kW) corner power rating. Current

applications include skid steer loaders, trenchers, sweepers, agricultural sprayers, vegetable harvesting equipment, and vibratory compactors. **Sundstrand-Sauer, Ames, IA (515) 239-6277.**

Tough-Toothed Belt Cuts Equipment Downtime

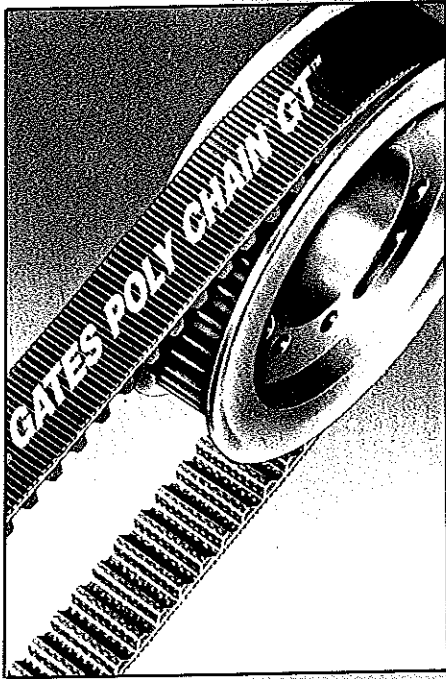

A polyurethane-molded, toothed, transmission synchronous belt, the **Poly Chain GT**, adds to the life of agricultural equipment drives. The belt is 98% energy efficient, can withstand severe shock loads, and lasts up to five times longer than chain. It is ideally suited for replacement and OE drives ranging from low-speed, fractional horsepower, to applications as high as 730 hp (544 kW) at 4000 rpm. Special modified curvilinear teeth, a ribbed back, and thin profile reduce friction, bending stress, and energy consumption by 5 to 10% when compared to V-shaped belts and roller chains. The belt is made from a special polyurethane compound which gives the molded teeth high shear strength during power surges and shock loads, and allows the body of the belt to resist abrasion, chemicals, and temperature extremes. It runs cleaner and quieter than most chain drives, and requires no lubrication and little retensioning. In contrast to rubber HTD and timing belts, the Poly Chain GT provides up to four times the horsepower ratings, and the entire drive package (belt and sprockets) weighs up to 33% less and uses up to 60% narrower sprockets. **Gates Rubber Co.**, Denver, CO (303) 644-5520.

High-Precision Outdoor Data Logging System

Designed for use in outdoor locations, the **HydroNET** logger measures and records soil moisture and temperature, air and water temperature, water level, and other environmental attributes. A three-wire interconnect serves as the communication channel within a network of data loggers. Precision laser-trimmed components provide higher accuracy over wide temperature and input voltage ranges. The switched capacitor and auto-zeroed circuitry

afford low-drift operation. The logger can store as many as 42,840 measurements using static Random Access Memory (RAM) devices. It also features low-power battery operation for remote applications. Once data is extracted from the analog logger using a lap-top computer, spreadsheet programs, statistical packages, or other computer programs can be used to analyze the data. **Design Analysis Associates, Inc.**, Logan, UT (801) 753-2212.

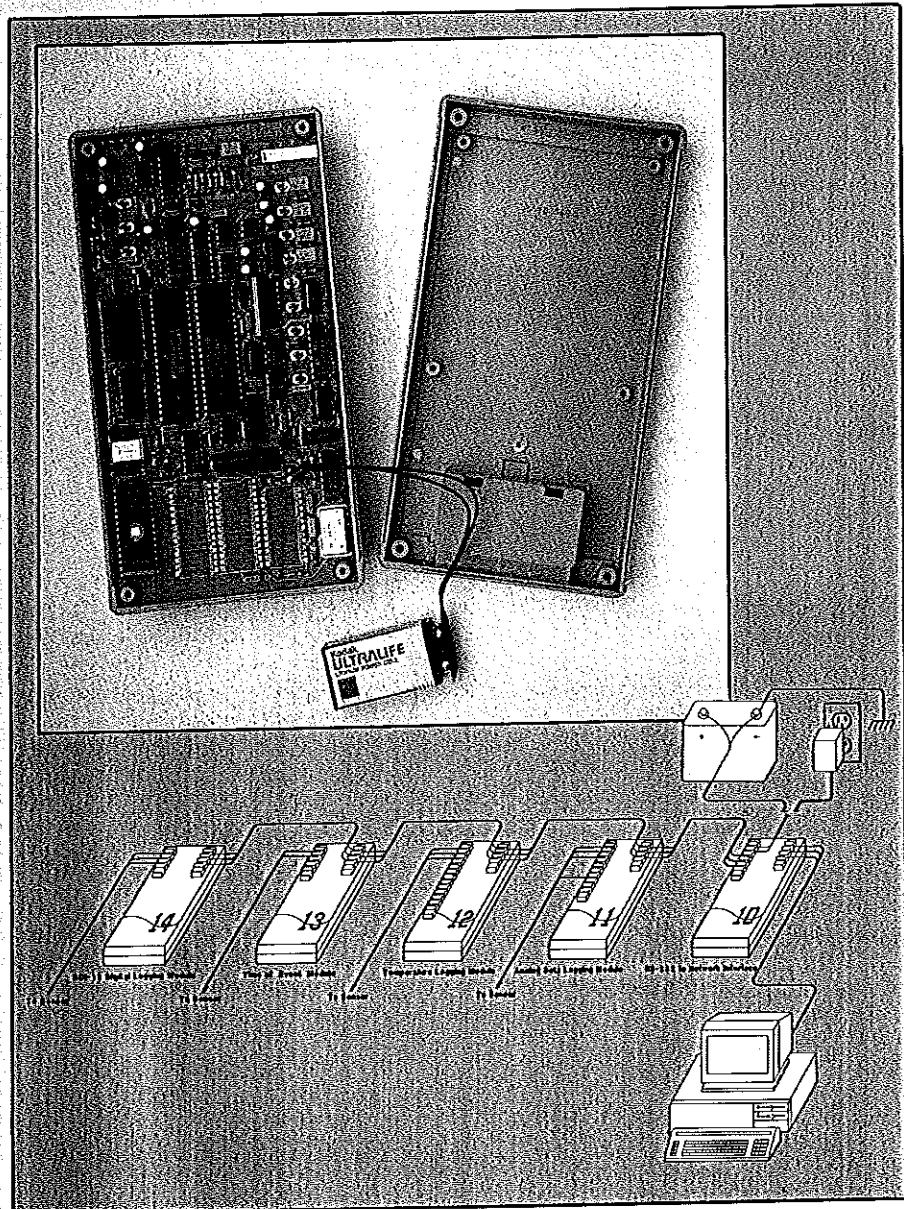

Drill Adds Versatility to Seeding Operations

The Model 750 No-Till Grain Drill offers added versatility in seeding small grains, forages, and legumes into seed beds of virtually any condition — no-till as well as varying degrees of conservational and conventional tillage. Effective in no-till farming and in double-crop regions, these 10- or 15-ft (3 or 4.6 m) machines are available with 7.5 or 10 in. (191 or 254 mm) row spacings and in a choice of either plain grain or combination grain/fertilizer models. Up to 450 lb (204 kg) of down pressure/opener can be obtained through machine weight, single-point hydraulic down pressure, and the addition of 10 tractor suitcase weights. Openers are mounted on two ranks, 48.5 in. (1232 mm) apart, with an underframe clearance of 24 in. (610 mm) for excellent residue flow characteristics. A single 18-in. (457 mm) flat disk blade runs at a 7-degree angle to slice residue and form the seed trench. A 4.5 x 16 in. (114 x 406 mm) gage wheel mounted beside the blade offers Max-Emerge™

depth gaging from 0.5 to 3.25 in. (13 to 83 mm) at the point of seed drop. A 1 x 12 in. (25 x 305 mm) press wheel runs in the seed trench, providing good seed-to-soil contact. It is followed by a 1 x 12 in. (25 x 305 mm) cast iron closing wheel that covers the seed with loose soil. Both wheels can be adjusted for down pressure in various soil conditions. Transport and meter drive wheels are located behind the machine to maintain equal operating and transport widths. **John Deere Des Moines Works, Des Moines, IA (515) 284-3058.**

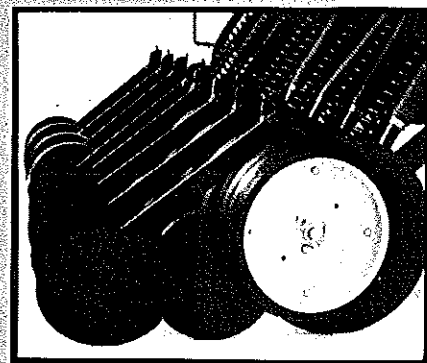
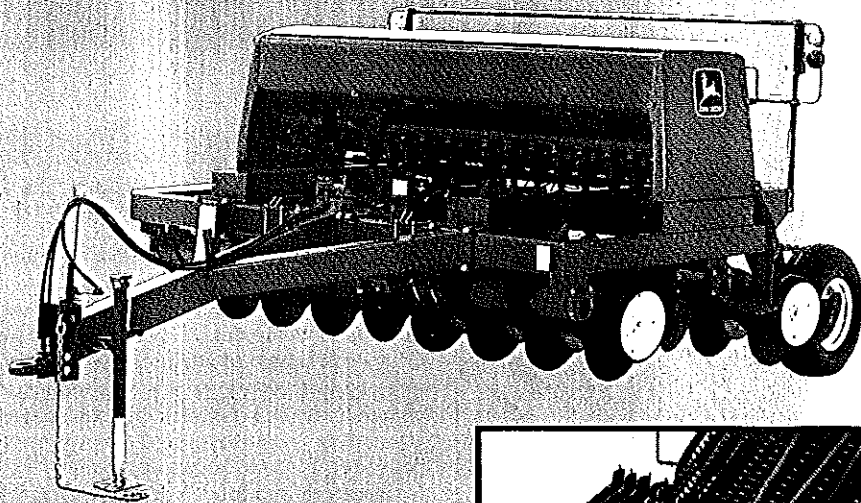

A single disk opener cuts through the toughest ground, including sod and heavy residue. The depth gage wheel ensures consistent seed depth, even in rolling fields.

Calculator for Accurate Chemical Application

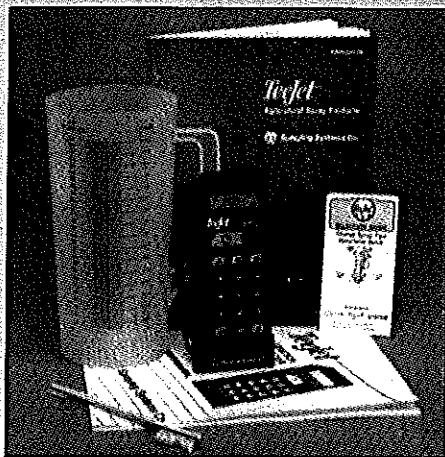
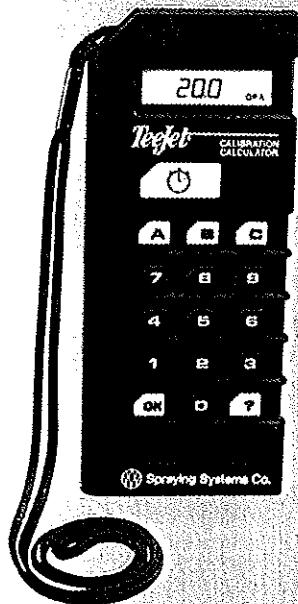

The Teejet Calibration Calculator Kit encourages sprayer calibration to optimize pest control and minimize risk to crops and the environment. It features a calculator with a built-in stopwatch to time sprayer speed and nozzle flow rate. Three programmed function keys "step" through the procedure to calibrate a field sprayer:

Accurate sprayer calibration helps to optimize pest control, minimize crop injury, and maximize return on pesticide investment.

determining sprayer speed; calculating necessary speed, nozzle spacing, and application or flow rate when three of the four variables are known; and checking nozzle flow rate. Agricultural sprayer calibration formulas have been preprogrammed into the calculator, which features low-power CMOS circuitry and automatic power-down for long battery life. The single-chip microcomputer offers direct LCD drive for minimum component count and data retention of variables. The display is shock-mounted for durability and the stopwatch timer is crystal-controlled for accuracy. The complete kit includes a graduated calibration container, a brush for nozzle maintenance, an instruction manual, a nozzle selection guide, and a spray products catalog. **Agricultural Division, Spraying Systems Co., Wheaton, IL (312) 665-5000.**



Hay Baler Features Electronic Controls

The **Model 8469** hay baler is designed to efficiently produce large, round bales — 5 ft (1.5 m) wide, up to 6 ft (1.8 m) in diameter, and weighing as much as 2200 lb (998 kg) — from the maximum amount of hay, in packages that can be handled by a standard farm tractor and loader. The system produces bales of consistently high density, which hold their round shape and offer improved weatherability when stored outdoors. Solid-state, electronic controls automatically actuate electrohydraulic valves to tie the bale, clutch the baler, open the tailgate, push the bale out of the path of the tailgate, close the tailgate, and reengage the clutch to start the baler. This reduces operator workload and fatigue, improves monitoring of baler functions, and enhances speed and productivity. A standard PTO-powered hydraulic pump supplies power for density and control functions. Only 70 hp (52.20 kW) is required to operate the baler. This self-contained hydraulic system provides a constant oil flow that maintains the operator-selected density. **Case IH**, Racine, WI (414) 636-6573.

Cut-Out Clutch Offers Overload Protection

The **Model K64** cam-type cut-out clutch is a mechanical overload protection device for agricultural implements. Upon creation of an overload condition, the clutch "cuts out", drawing only minimal torque until speed is reduced and the clutch reengages. An opposing-cam design permits only limited reengagement until speed is reduced. Because it draws near-zero load while in the overload mode, slip clutch "burn up" is eliminated. At speeds below 200 rpm, the clutch delivers a pulsating load. The locking cams engage into two grooves of the housing. Because this housing is provided with a total of four grooves, four engaging positions per rotation are possible. The clutch operates only in the intended direction of rotation — either clockwise or counter-clockwise. A fully automatic reset enhances safety, and eliminates the need for the operator to come in contact with the drivetrain. The clutch greatly reduces heat generation and eliminates the need to change the shear pin. It is completely sealed against outside

contaminants and is designed with no protrusions on the outer diameter. This clutch can be offered either integrally with a universal joint driveline, or as an "in-built"

clutch mounted directly to the sheaves, sprockets, or other drivetrain components. **Walterscheid, Inc.**, Burr Ridge, IL (312) 887-7022.

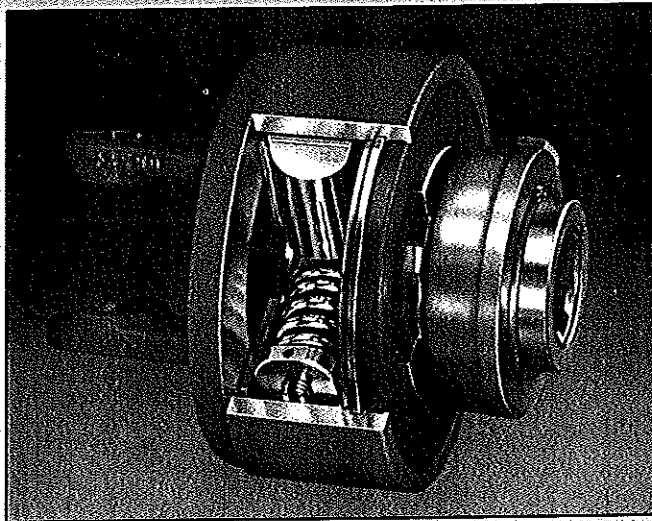

The opposing-cam design reduces aggressive attempts by the clutch to reengage itself, thereby reducing pulsating load.

High-Capacity Rectangular Hay Balers

This family of 14 x 18 in. (356 x 457 mm) rectangular balers offers improved bale shape and product value at higher capacities. Designed on CAD, these 1.65-m (65 in.) metric balers were developed for worldwide use. Standard features include a strong bale chamber with six hay dogs to hold charges in place; a belt-driven pickup that acts as a slip clutch to prevent overloads; a pickup gage wheel that compensates for uneven field conditions as it protects the curved pickup teeth; fast plunger-head speed and 30-in. (762 mm) stroke; a 22-in. (559 mm) flywheel that allows for smooth power transfer; and a choice of either gear-driven knotters or twisters. Speed is set to maximize baler capacity — from 79 to 93 strokes per minute (spm). The **Model 565** — which is equipped with the Flo-Action[®] feeder (79 spm) — and the **Model 570** each include a packing fork and two or three sets of rotating fingers. Designed to handle a broad range of crops and conditions with nine position adjustments that require no tools, the **Model 570** and **Model 575** offer 93 spm and feature the new rotary feeders with

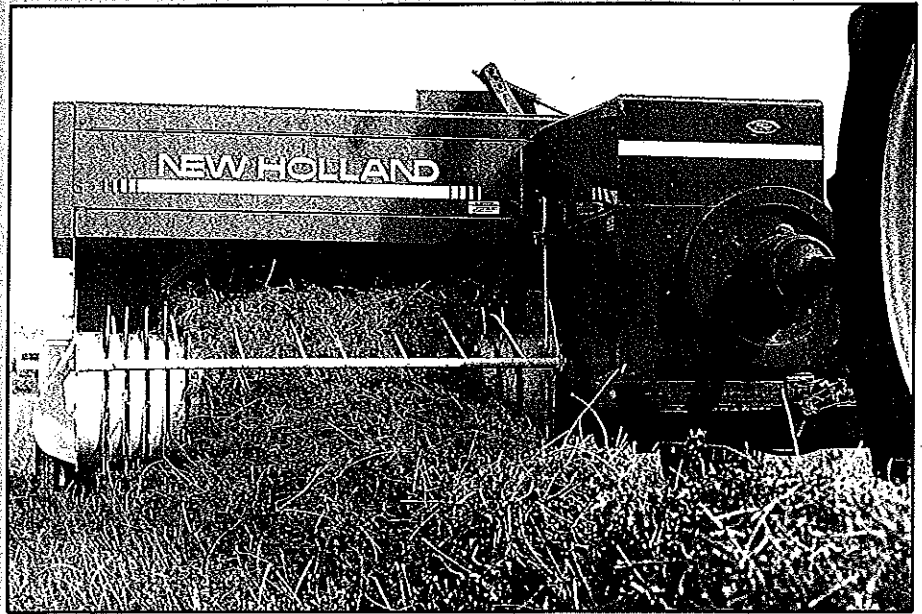

adjustable feeder forks. Both the Flo-Action[®] and rotary systems are adjustable to work in varying crops — from alfalfa to slippery grasses. Along with over-running drives, a three-disk clutch on the 575 and two-disk clutch on the 565 and 570 afford gentle load engagement, long life, and greater load capacity. Flotation tires are

standard on the 570 and 575, and optional on the 565. The exclusive power-pivot PTO is also standard on the 570 and 575, and on the 565 with three-joint PTO. Attachments for all models feature hydraulic pickup lift, hydraulic tongue swing, and bale throwers. **Ford New Holland, Inc.**, New Holland, PA (717) 355-1311.

High-Volume Automatic Food Sorting System



Employing an innovative optomechanical arrangement that permits it to simultaneously view in two visible colors, the **ColorSort™** system performs

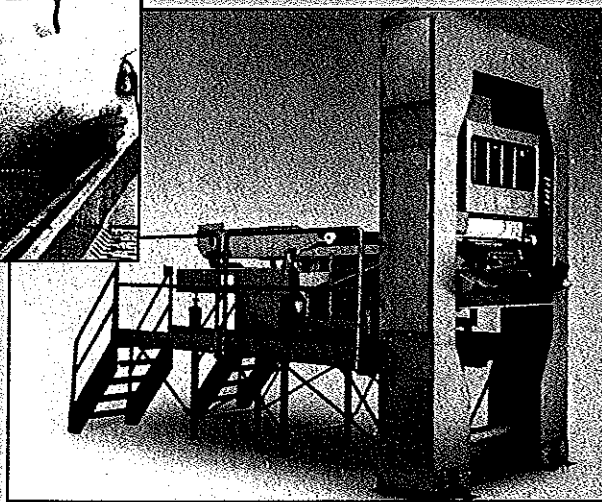

in-line optical inspection and subsequent removal of defects in fruits, vegetables, and other food products. It consists of material handling, vision, computer, human interface, and defect-removal components which allow viewing of a moving product stream from several angles with multiple spectral response. A dichromatic line-scan camera, featuring internal preprocessing and dedicated electronics, eliminates transition picture elements. Solid-state cameras, equipped with a number of filtered sensors, are controlled by a special VME bus-based computer system. They utilize programmable logic devices (PLDs) for expanded flexibility in adopting to specific products being processed. Human interface is achieved through an industrial PC/AT computer using simple, menu-driven commands. The system reduces dependence on manual labor, increases processor flexibility, and enhances end-product quality. **Key Technology, Inc.**, Walla Walla, WA (509) 529-2161.

Hand-Held Computer Records High-Speed Analog Data

The 700 Series Polycorder[®] is a hand-held data acquisition computer designed to measure and record high-speed analog data in rugged and highly mobile environments. When appropriate sensors are connected, it displays and stores measurements of temperature, pressure,

displacement, strain, vibration, and other critical physical parameters associated with the industrial and environmental aspects of agricultural engineering. Suitable for mounting almost anywhere on agricultural or food processing machinery, it also monitors duty cycles, atmospheric turbulence, soil penetration and erosion, and irrigation system performance. Capable of providing analog scanning at rates up to 76.8 kc/s (76.8 KHz), this 2.4-lb (1 kg) computer measures only 8 x 4 x 2.1 in. (203.2 x 101.6 x 53.3 mm) and is available with up to 448K bytes of RAM. An auxiliary digital signal processing board, with an instructional cycle time of 200 nano-seconds, draws power when not being used. The unit also features a programmable anti-alias filter, the highly integrated, low-power X64180 microprocessor chip, a customized logic array, and more than 300 (primarily surface-mount) components. **Omnidata International, Inc.**, Logan, UT (801) 753-7760.

The 700 Series Polycorder effectively performs a number of data acquisition tasks in agronomy studies and agricultural machinery performance.



Poultry Feeding System Uses Centerless-Core Auger

The "H2 Feeder" system utilizes a centerless-core auger and roll-formed tube to deliver feed to individual feeder pans. The plastic feeder pan assembly has no grill and uses a window feature to flood the pans. (A windowless model is also available.) A center cone serves as the feed control device and support for the 13-in. (330 mm) round-bottom feed pan. The unit's three support legs can be adjusted to vary the distance between the pan and cone. The inner and outer diameters dictate the size of the feed area. The center cone assembly features feed flow windows which allow feed to flow out over the cone and into the pan. This feed flow is controlled by two feed chutes. The small, ring-type chute allows for a higher feed level, and is used to start day-old birds. The long feed chute allows less feed to enter the pan, making it appropriate for use in the turkey market or in other applications in which control is important. All parts are made of polypropylene with UV stabilizer. **Chore-Time Equipment**, Milford, IN (219) 658-4101.

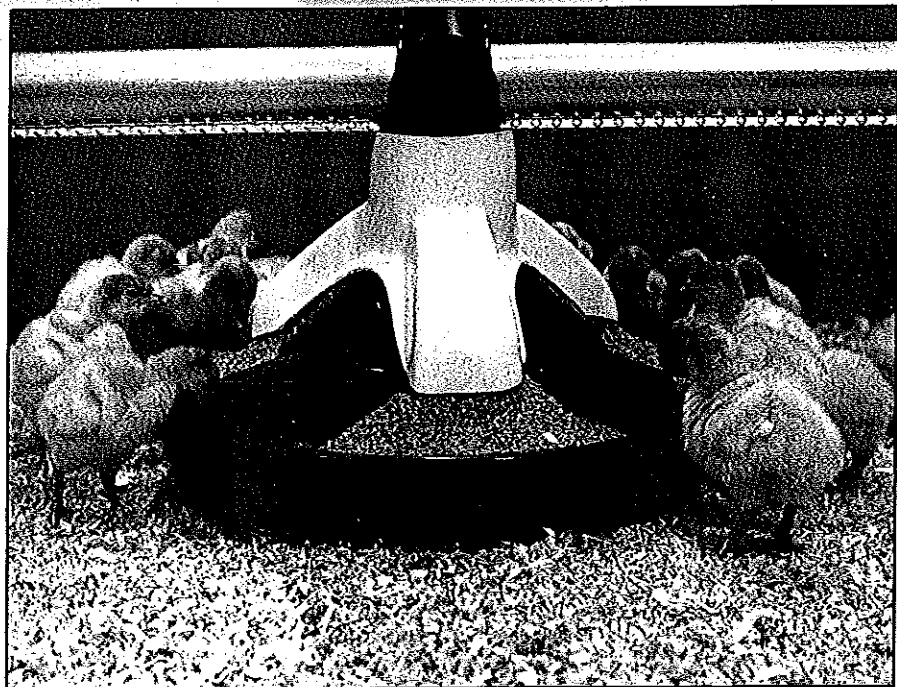

Lightweight, High-Speed Ground Sprayer

The **Model 230 Spra-Coupe** — a self-propelled, high-speed, low-volume liquid chemical applicator — has a 50-ft (15 m) three-section boom. Each of its four wheels features individual spring suspension and can be adjusted to tread widths of 78 to 108 in. (1981 to 2743 mm). High ground clearance and wheel shields permit spraying of the tallest crop at speeds of up to 18 mph (29 km/h). The sprayer is equipped with a 210-gal (795 L) polyethylene tank and features a fully enclosed ventilated cab with air conditioning. Microprocessor technology is used to maintain a constant application rate regardless of variations in speed, thereby preventing over- or under-application of the chemical. The use of electric pressure gages, flow control valves, and flow meters allows remote control of on/off/flow functions without exposing the



operator to chemicals in the event of a fluid-line rupture. On-the-go control of the boom position and boom spray selection permits the operator to better control the drift of chemical outside the desired target area. The lightweight machine minimizes crop

damage and can be successfully operated in wet soil conditions. The two-wheel drive engine/transaxle is rear-mounted. A tow hitch allows for transportation of the system between job sites. **Melroe Co.**, Bismarck, ND (701) 222-5744.

Locknut Promises Zero Leakage at Threaded Joints

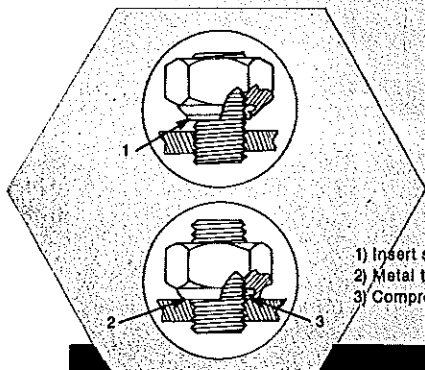

- 1) Insert slips outward against bearing surface.
- 2) Metal to metal contact/insert fully encapsulated.
- 3) Compression from installation produces a 360° sealing/locking ring.

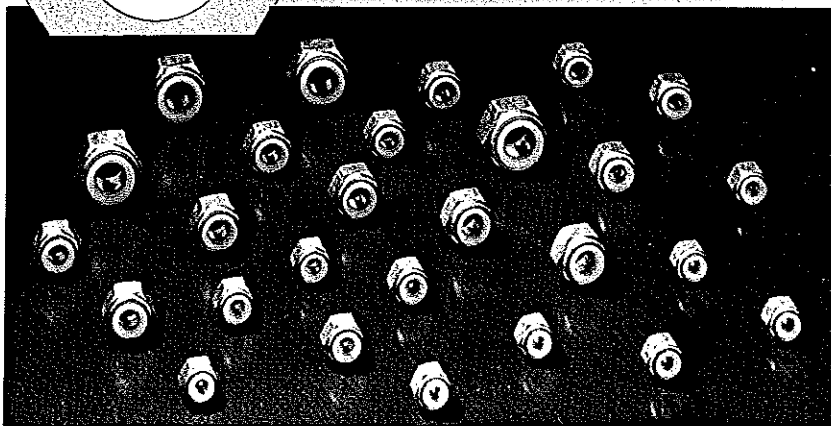

The **Hydra-Lok** one-piece sealing locknut eliminates the need for washers, surface preparation, costly construction measures, packings, and additional parts in the vibration-proof sealing of bolt and nut joints. Made of tough Zytel[®] nylon, its sealing/locking insert is

effective under pressure and possesses enduring elastic properties. The permanent, reusable gasket is mechanically encapsulated within the working sealing face. It eliminates leakage of contained fluids at threaded joints and/or threaded plumbed areas. During installation, the insert protrusion outwardly slips against the bearing surface. A partial fold or "turtleneck" effect compresses the insert to seal and lock as metal-to-metal contact is achieved. Insert compression produces a 360-degree sealing "pressure ring" about the bolt threads and bearing surface, simultaneously damping vibration. Metal-to-metal contact maintains preload while insert compression seals and prevents movement. The sealing/locking insert is unexposed to external damage. When loosened for calibration or removal, the insert's "memory" works to help it regain its original shape. Reinstallation recompresses the turtleneck effect to seal and lock the fastener. The locknut can be manufactured in special configurations from any commercial metal and in all finishes. Special and metric threads are also available. **Abbott Interfast Corp.**, Wheeling, IL (312) 459-6200.

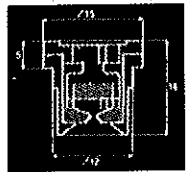
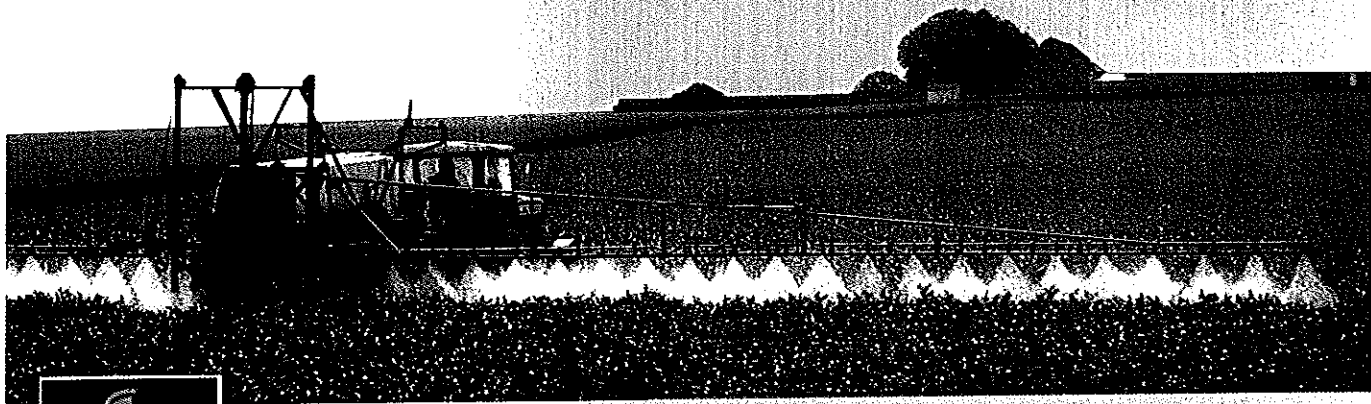

High-Precision Ceramic Spray Tips

High-precision **Albuz[®]** ceramic spray tips are designed for use in the spraying of pesticides, fungicides, liquid fertilizers, and herbicides. Made of a ceramic insert, they are fitted into a plastic body (which is impervious to acids) for added protection. The ceramic material is wear-resistant and carries a hardness rating

of 2300 vickers — near that of a diamond. In addition, its life span is two to three times longer than that of conventional spray tips. These injection-molded spray tips can be used to replace any standard spray tip. Each one is color-coded to represent a different flow rate. The spray pattern of the flat-fan spray tip offers a variation coefficient of less than 10. Production is robot-controlled in a flow rate at $\pm 5\%$. The sprayer can be easily calibrated, allowing for better control of expensive chemicals. **Carbone USA Corp.**, Boonton, NJ (800) 526-0877.

Chisel Plows for Conservation Tillage

Because of their accurate fore, aft, and lateral depth control, both the **Model 5600** (regular clearance) and **Model 5700** (high clearance) flat-fold chisel plows are designed for use in primary or secondary conservation tillage and are ideally suited to chemical incorporation. Designed on a CAD system, they have a working width of 17 to 27 ft (5 to 8 m) and are comprised of a center section and two wings. Each wing folds 180 degree on top of the center section (a flat fold), for a narrow 14-ft (4 m) transport width. On 17 to 21-ft (5 to 6 m) models, the wings are rigid in the working position. On the larger models, the wings are free-floating to follow ground contour. The depth-control system consists of a mechanical crank adjustment at each set of depth wheels — one turn corresponds to 0.5 in. (13 mm) variation of actual depth. This eliminates uneven depth from the center section to the wings, which traditionally results due to internal leakage from depth-control hydraulic cylinders. The actual

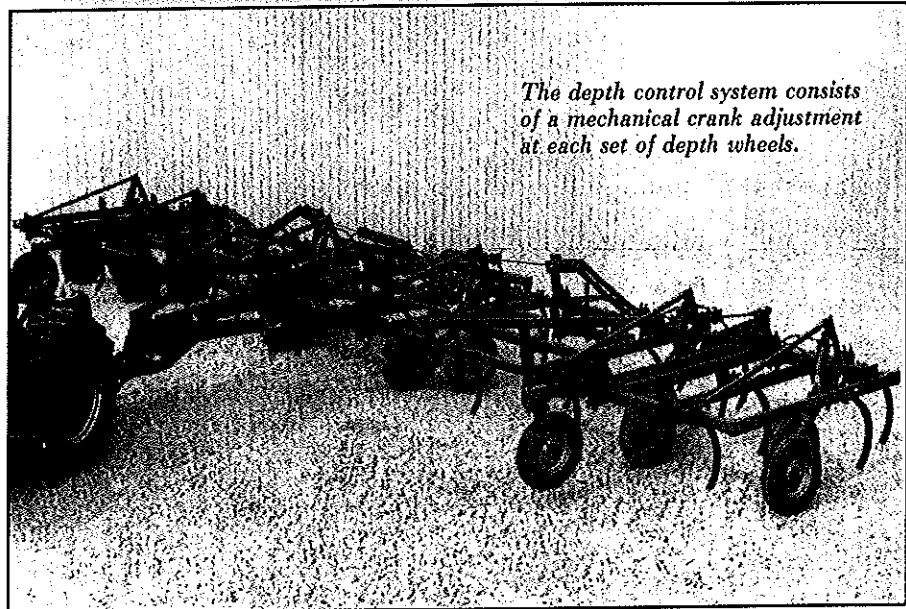

The depth control system consists of a mechanical crank adjustment at each set of depth wheels.

depth can be preset and then continually monitored by the depth indicator. The unique level-lift hitch automatically maintains a level condition for all depth settings. Each compact plow is easy to adjust, operate, and transport down narrow roads and through narrow gates. **J I Case**, Hinsdale, IL (312) 789-7149.

Gerotor Motor Brake Adds Design Versatility

The high-efficiency gerotor motor with multiple disk brake features machine parts held in place with spring-loaded, pressure-released disks rather than hydraulic motors. The **HB/Motor Brake** couples high initial efficiencies with high flow efficiencies. Motor high-pressure seals are pressure-compensated face seals that compensate for pressure as well as wear. The brake is a nested-coil, spring-engaged, pilot pressure release with service brake actuation and long-life piston seals. The torque is rated at 6000 in.lb (678 N·m), and the brake contains 136 in.² (877 cm²) of high-energy metallic lining. This motor and wet disk brake combination eliminates one housing and one shaft, and saves on pump sizing, component costs, space, and fuel. It

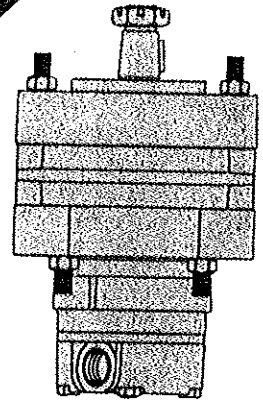
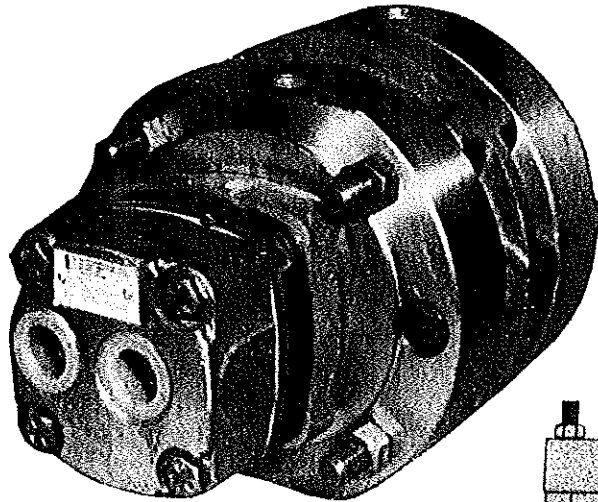

offers the equipment designer greater flexibility in component selection and promises minimum leakage potential. Assembly of the motor, brake, and cartridge valve components is compact and economical, affording maximum utilization of space. **White Hydraulics Inc.**, Hopkinsville, KY (502) 885-1110.

Thermal Processing Retains Natural Product Qualities

This steam/air horizontal-batch retort provides an efficient means of transferring heat units to food products while preserving their natural qualities. The **Steristar Retort Line** provides for shortened retort cycle times, minimized heat and water loss, and precision control. It utilizes the steam/air principle with air overpressure which permits the processing of all containers, including those that are highly pressure-sensitive. This commercial sterilization system — composed entirely of U.S. built components — permits temperature control to within less than 1°F (-17°C) and pressure of less than 1 psi (7 kPa) during routine batch processing. Due to the specially designed, preheated air system, excellent ramping characteristics and superior uniformity of temperature and pressure curves can be achieved. The retort is automatically controlled by an Allen Bradley/Micristar key programmable Process Control system, which controls all cycles of the sterilization process. All vessels are built in accordance with ASME standards, and all controls are NEMA-4 rated (water hose-down protected). **Container Machinery Corp.**, a Truxton™ Company, Hudson, NY (518) 828-5770.

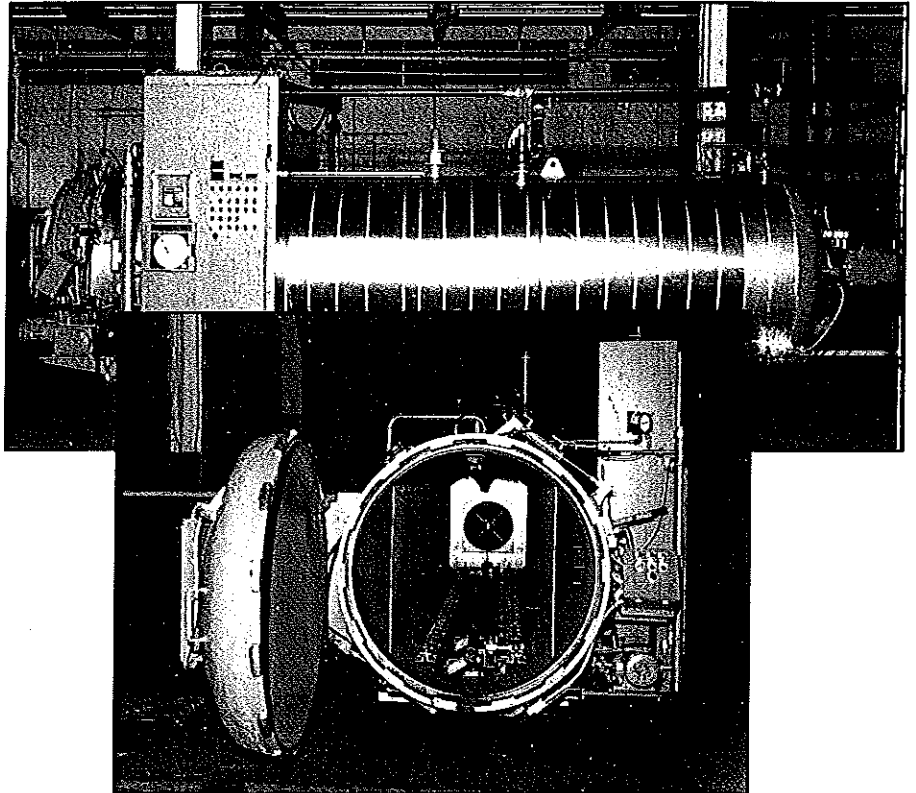

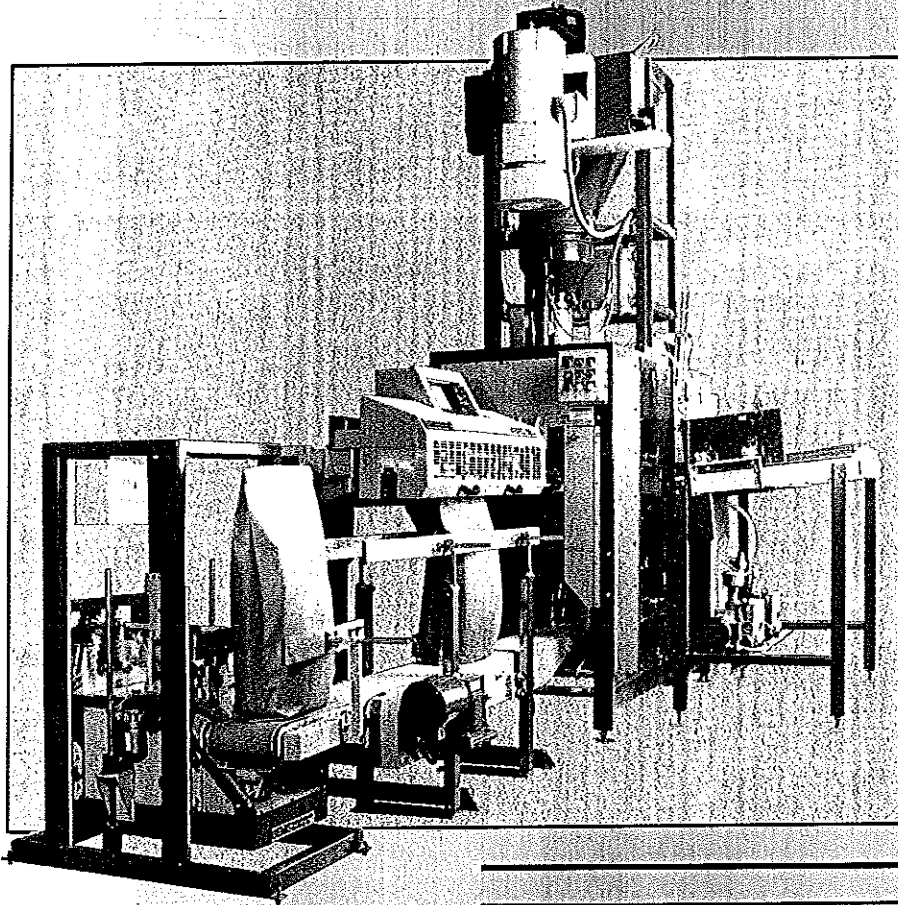

Powder-Product Packaging System Automates Task

Fine powder-type products (primarily flour) can be automatically packaged in 25 lb to 100 lb (11.5 kg to 45 kg) bags at speeds of up to 14 bags per minute. The **Packer-Aid II** utilizes the Bemiscan Data Center module for overall system control and allows the operator to monitor all vital data for the system during its operation. Weight information for each filled and sealed bag is sent to the Data Center via the Checkweigher module. Through use of the unique auger fill-tube principle and dust collection, dust generated by the filling process is kept to a minimum. The latest in electric linear actuator technology is utilized in control of the auger fill-tube, the operation of which is programmable to tailor its function to the type of product being run. The bag-placing module operates with either pinch-bottom, open-mouth (P.B.O.M.) or sewn open-mouth (S.O.M.) style bags. **Bemis Packaging Service Machinery Co.**, Minneapolis, MN (612) 782-1200.

Electronics Enhance Operator Safety

By incorporating an electronic system for proper sequencing and delays in the hydraulic interlock and starting interlock systems, the **Operator Restraint System** enhances operator safety on skid steer loaders. It features a seat switch, seat belt switch, hydraulic lockouts, and control module. The seat switch and seat belt switch must operate in sequence before the start circuit and hydraulic system become operable. Resequencing occurs each time the operator leaves the seat. A seat belt retractor and logic-controlled "fasten seat belt" light make the system more convenient for the operator. Diagnostic lights aid in locating a system failure. **Ford New Holland, Inc.**, New Holland, PA (717)355-1323.

The operator restraint system is designed to foil any attempts to bypass its use.

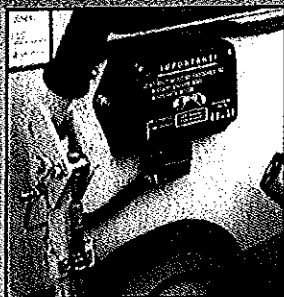
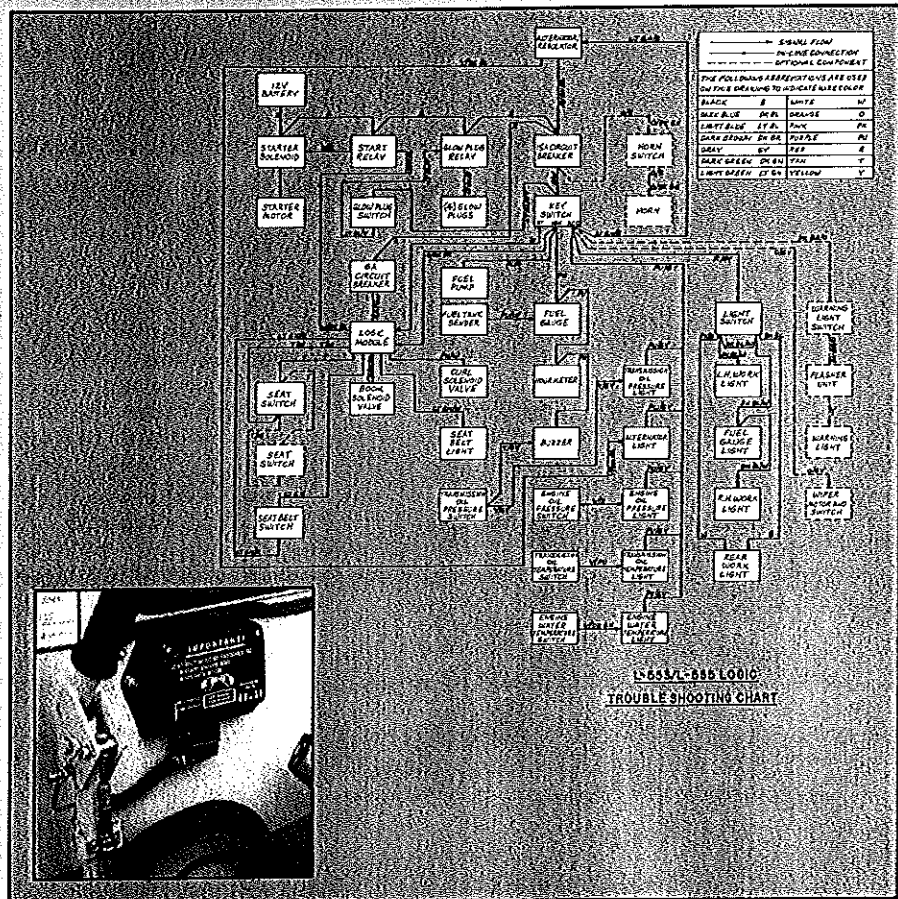

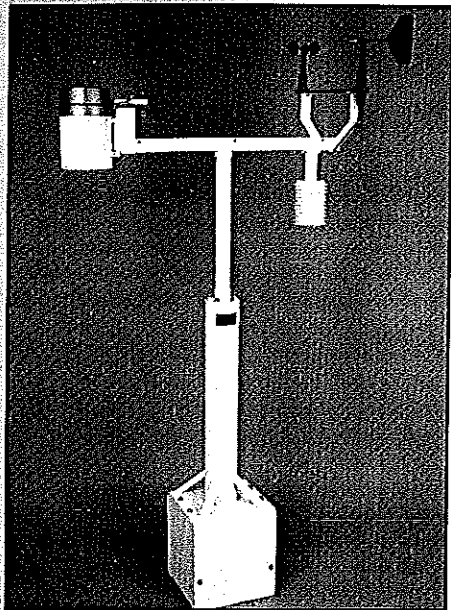

Weather Station Aids in Crop Management

The fully automated **Model 012** weather station provides reliable measurement and timely reporting of climatological conditions for use in crop management decisions, irrigation scheduling, integrated pest management, and other agricultural processes requiring real-time climatic information. Raw or processed weather data is retrieved on demand via telecommunications options. Data is generally downloaded automatically from the weather station to a computer at a remote location. The self-contained station is bolted to a concrete pad for increased

stability. A sealed internal canister reduces effects of humidity on internal electronics. The prewired sensors are connected to the preprogrammed datalogger via various two-pin and four-pin connectors. Terminals and housings for the connection of a communications peripheral and station power supply are protected within the base of the station. Internally routed sensor cables reduce harmful effects of weathering, abrasion, and rodent damage. **Campbell Scientific, Inc.**, Logan, UT (801) 753-2342.

Gauge Measures Sap Flow in Crops

A system based on the energy-balance within a heated stem segment, the portable **Dynagage** stem-flow gage directly measures the mass of flowing sap by the amount of heat carried up the stems of plants, crops, and trees. It utilizes nonintrusive methods and requires no calibration. The Dynagage can determine the amount of water a crop is presently using and how much ground water must be

replaced. The electronic stem-flow and trunk-flow gauges attach to a microvoltmeter or data logger to supply accurate measurements of sap flow in gm/hour, power flux and temperature gradients, accumulated water consumption, and 30-minute dynamic response. Heat-flux sensors read directly into a four-channel data log recorder. With the supplied program (for 21X, CR7), sap flow is

computed and accumulated and users can see the effects of radiation, wind, and moisture almost instantly. In this unique construction, Iconel heaters are etched onto a Katpon substrate and laminated with Mylar to produce heaters that provide a constant heating source. This constant heat energy-balance method has a proven 1% margin of error. **Dynamax, Inc.**, Houston, TX (713) 771-4224.

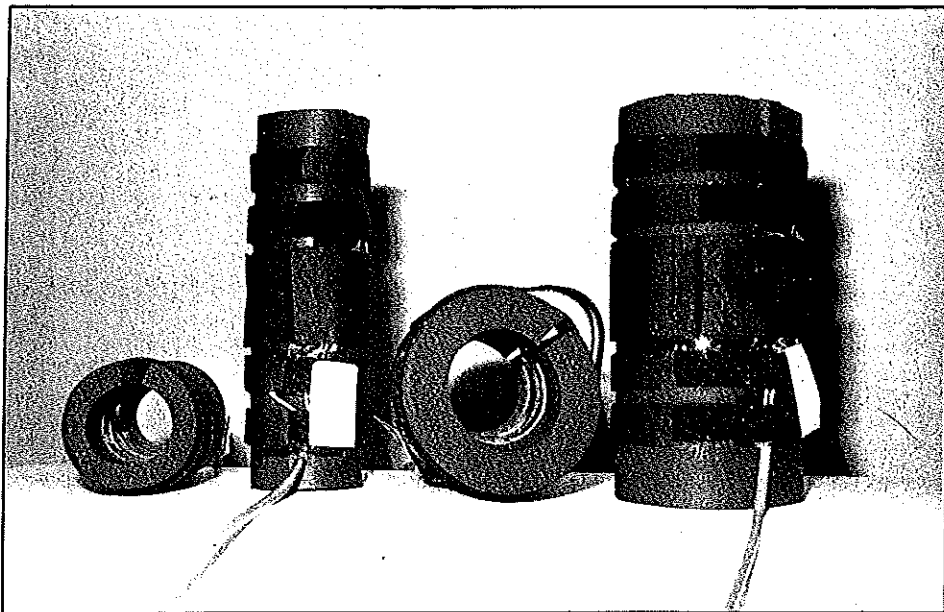

Electrostatic Sprayer Increases Chemical Coverage

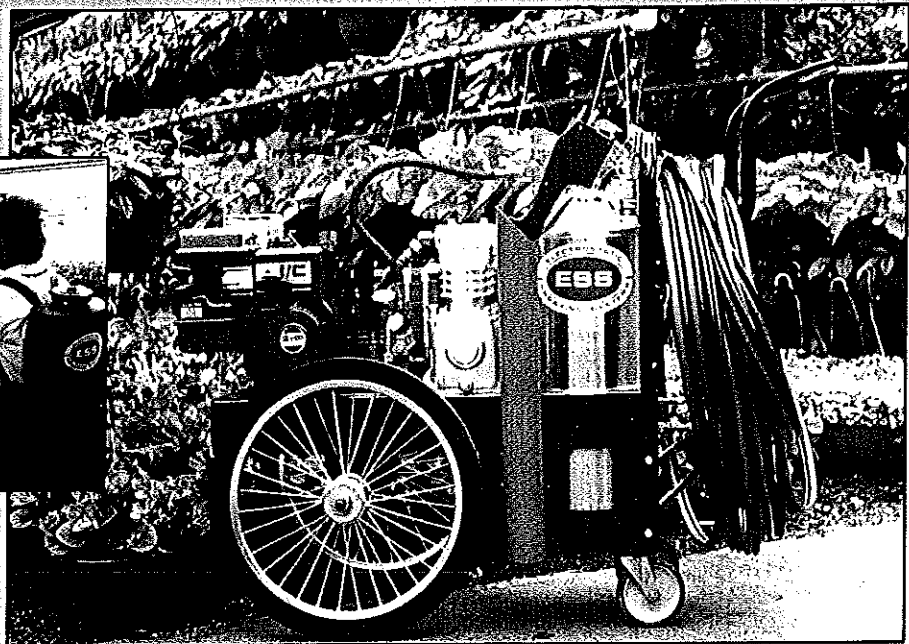

An electrostatic handgun coupled with an air and liquid delivery system contains all components (including the power sources) necessary for growers to spray electrostatically charged chemicals quickly, safely, and more efficiently than with standard hydraulic sprayers. In both the **Model GPS-5** self-contained pull-style sprayer and the **Model BP-4** backpack spraying system, liquid is supplied to the handgun without the aid of pumps. The unique dual-nozzle design is in a 2 in. (51 mm) diameter package so that each nozzle port maintains its optimum rate and trajectory compatible with hand-held delivery in a greenhouse or nursery environment. The spray pattern is a solid cone with a trajectory of 20 ft (6 m) and a

cloud diameter of 3 ft (1 m). Specially formulated, chemical-resistant epoxy resins and fiberglass were molded to produce a handgun body that is attractive and lightweight, and which functions within the required parameters of strength, ductility, and impact and abrasion resistance. An air switch in the handgun allows charging of the nozzle only when air flows, eliminating the

possibility of shock. A simple, sensitive feedback loop detects ground current in the liquid stream and signals the operator that the nozzle is correctly charging with spray droplets. These sprayers provide an efficient, safe, and environmentally compatible chemical delivery system. **Electrostatic Spraying Systems, Inc.**, Athens, GA (404) 353-0695.

Benefits include more uniform coverage, increased deposition, and excellent penetration into hidden target areas.

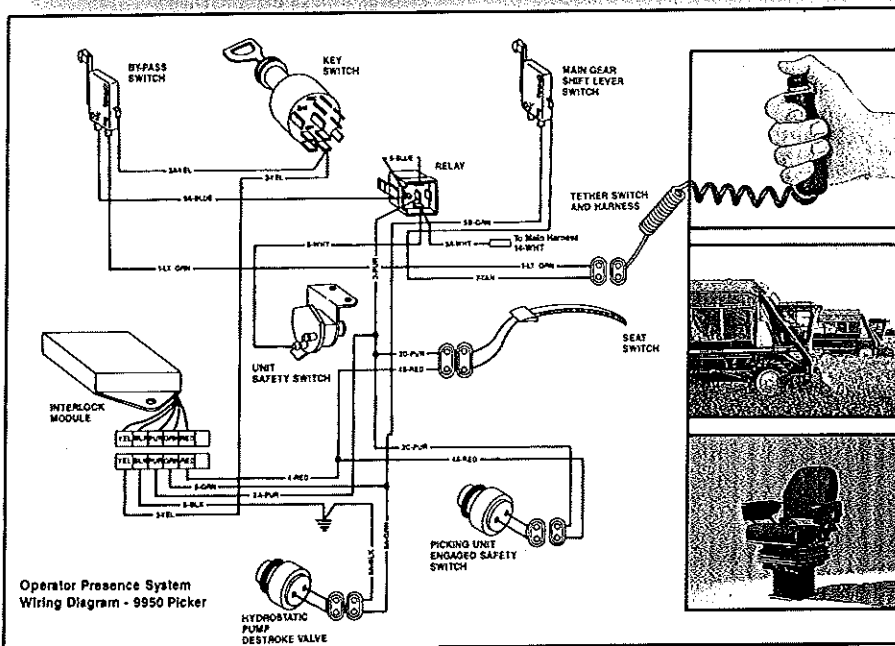

Picking Unit System Increases Operator Safety

Designed to reduce the risk of operator entanglements in mechanical cotton-pickers, the two-part **Operator Presence System** consists of a seat-activated interlock with the picking unit drive. If the operator leaves the seat for more than five seconds, the picking unit will immediately halt rotation and ground travel. In addition, the system features a service bypass switch that allows the operator to inspect or clean the row units while they are slowly rotated. Mounted on an expandable tether, this switch facilitates ground-level operation while lessening the possibility of entanglement. A new rear screen design eliminates trash build-up and provides a permanent SMV mounting location. **John Deere Des Moines Works**, Des Moines, IA (515) 289-3058.

Water / Air System Keeps Canned Products 'Cool'

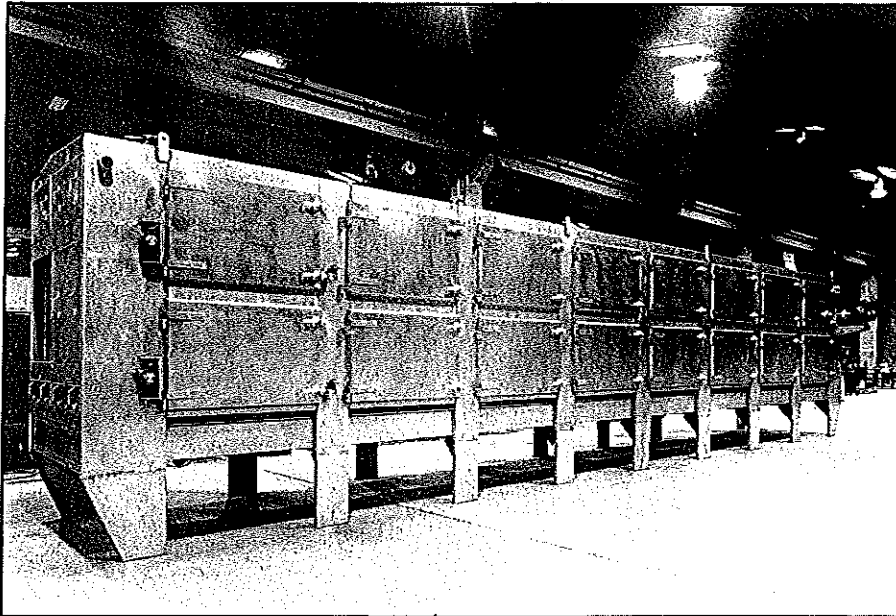

This cooler for canned products features evaporative, multistage cooling with minimum water and space requirements, and results in superior ingredient distribution, fat cap reduction, and general quality improvement.

By means of recirculating water, moving air, and a sophisticated track system, the **PacRite Spin Cooler** provides maximum cooling for canned products in a minimum of floor space. In its multilevel, multilaned track system, a can may travel 1200 ft (366 m) or more in a floor space no larger than 6 x 40 ft (2 x 12 m). Cans enter the cooler through a twist assembly and feeder, which provides sequencing between moving pusher bars. These bars afford positive propulsion of cans through the tracking system. Containers are conveyed horizontally through vertical curves, and are shifted laterally with complete capture and control of orientation, rotation speed, and synchronization at entry. The cans' rolling action causes the product to mix while cooling, thereby dispersing the hot core and reducing cooling time. Water spray falls on two or more cooling zones in a programmed counterflow system. Cooling is further enhanced by air drawn through the spray, providing convective and evaporative cooling and reducing water usage and required retention time. **Aeroglide Corp.**, Raleigh, NC (919) 851-2000.

Compact Heater Keeps Tractors On the Job

The 15,000-Btu (15 826 kJ) **Tuck-Away** heater is particularly applicable in compact diesel tractors that have limited interior cab space. Because it is actually incorporated into the structure of the cab and does not infringe on the operator, the heater enhances operator safety. The front lower mount is indented and serves a dual purpose — supporting both the windshield and heater. Use of this heater affords increased utilization of tractors in all weather conditions, resulting in heightened productivity. **Curtis Tractor Cab, Inc.**, Worcester, MA (508) 752-4086.

This 15,000 BTU heater is actually incorporated into the structure of the cab.



Crop Monitoring System Uses Infrared Telemetry

A total crop stress monitoring system, **CropLink™** is the first weather station to make infrared thermometers a standard component. It consists of a hardware and custom software package that collects, interprets, and transmits data to any farm office PC. Compatible with virtually any irrigation control system, the self-contained field station continuously monitors air temperature, relative humidity, wind conditions, and plant water stress. Data is interpreted by the station's on-board computer and transferred by infrared telemetry to the central control station. This on-going profile of true plant conditions allows the crop manager to base watering decisions on actual crop needs, reduce irrigation costs while maintaining maximum yields, and detect crop stress before it is visible to the eye. The system operates on a wireless, infrared data link which is considered to be lightning-safe and unaffected by radio interference. It requires little maintenance. Stations can be daisy-chained throughout the user's fields at up to 1-mi (1.6 km) increments. **Carborundum, Instrument Technologies Group, Solon, OH (216) 349-6887.**

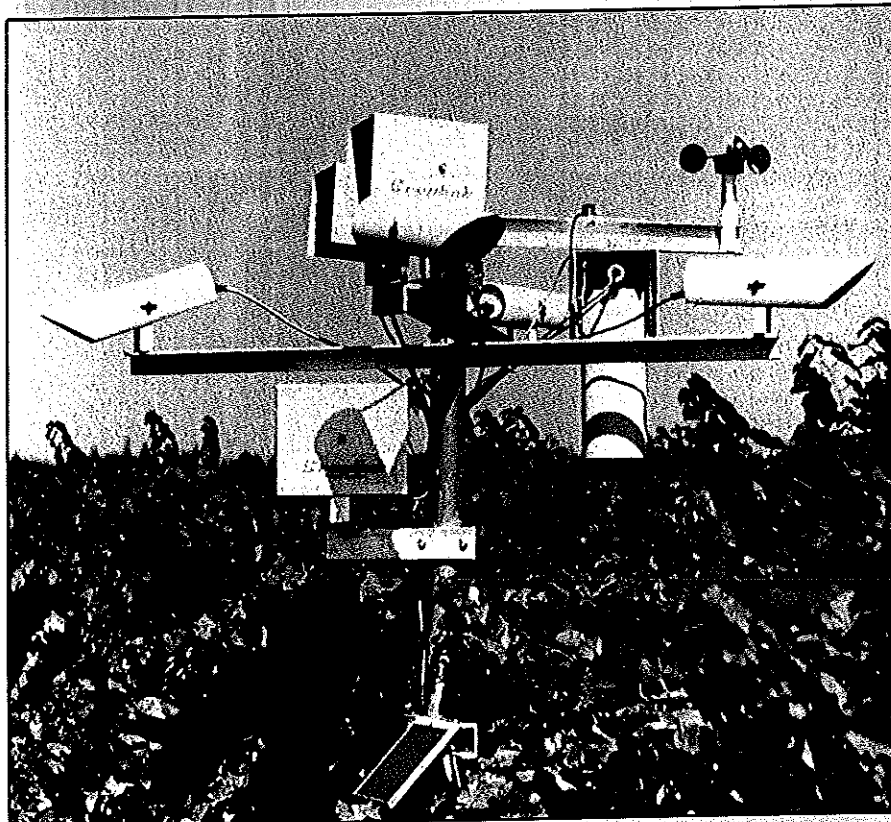

Actual plant conditions can be monitored to help determine watering needs, irrigation for maximum yields, and crop stress identification.

'Bug Counter' Aids in Pest Management

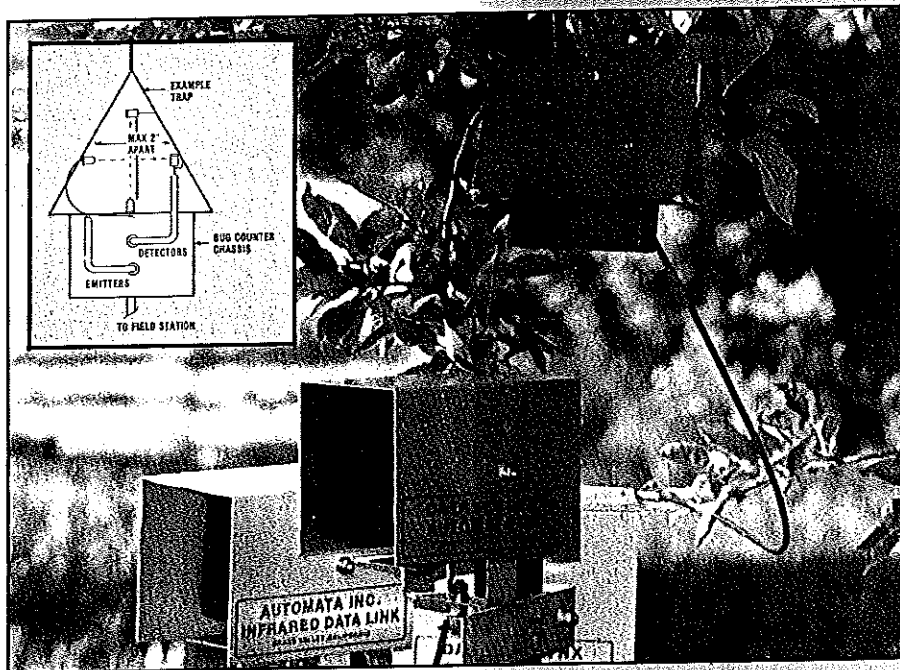

Designed for use in production, research, and (potentially) storage of agricultural products, the **Bug Counter** enhances pest management techniques. As an insect — attracted by the pheromone in the specially designed trap — enters, an infrared beam is broken and a count is registered. Information on insect counts and peak insect activity times can be transmitted from remote fields and/or greenhouses to a central computer. There, the data and time are logged with the count and the count is accumulated. The result is a real-time insect count on which to base insect control decisions. The computer can be programmed to automatically sound an alarm when a threshold number of a particular insect is reached, thereby alerting personnel that it may be time to implement pest control measures. The Bug Counter, compatible with Automata's DATA = LYNX telemetry system, improves planning for timely and efficacious pest control. **Automata, Inc., Grass Valley, CA (916) 273-0380.**

Spreader Promises Uniform Fertilizer Application

Particularly efficient with lightweight, granular fertilizer materials, the **New Leader Model L-1000** air spreader can also be used for the uniform application of material blends of varying particle sizes. Because directional changes in its straight-line air flow system are minimal, velocity loss is reduced and operational energy requirements are minimized. The spreader's material divider uses a multiple-compartment hopper to divide the fertilizer

stream into 16 smaller streams. These streams are, in turn, channeled into narrow venturi tubes that are arranged alternately for left and right discharge. Two hydraulically driven blowers provide a high-velocity air stream that is subdivided into these tubes. As the air passes the venturi restriction, it conveys the granular particles through the tubes, along the boom, and out through the nozzles. Sixteen nozzles, spaced

at 37.5-in. (95.3 mm) intervals, provide a spread width of 50 ft (15 m). Air velocities of 6500 to 7000 ft/min (1981 to 2134 m/min) assure consistent transport and distribution. This self-contained system includes a retrofit package that affords its conversion to a spinner-type spreader. Booms, which fold for transport, are equipped with a positive lock to prevent accidental deployment. **Highway Equipment Co.**, Cedar Rapids, IA (319) 363-8281.

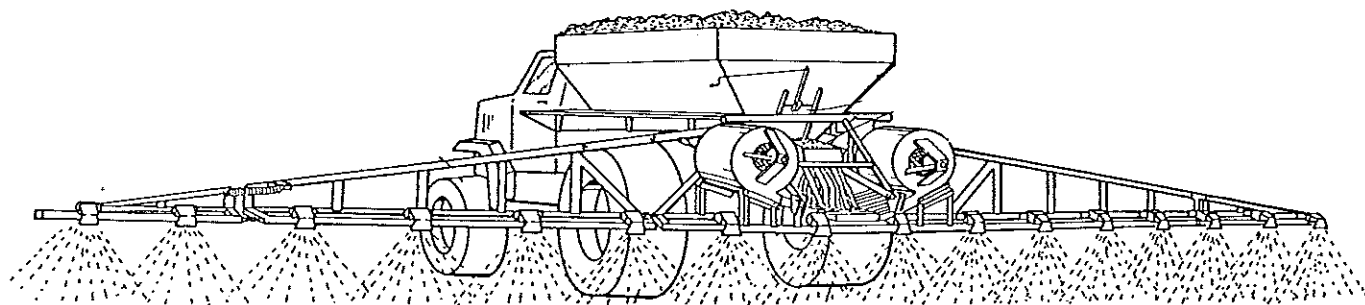

Microcomputer-Based Infrared Temperature Transducer

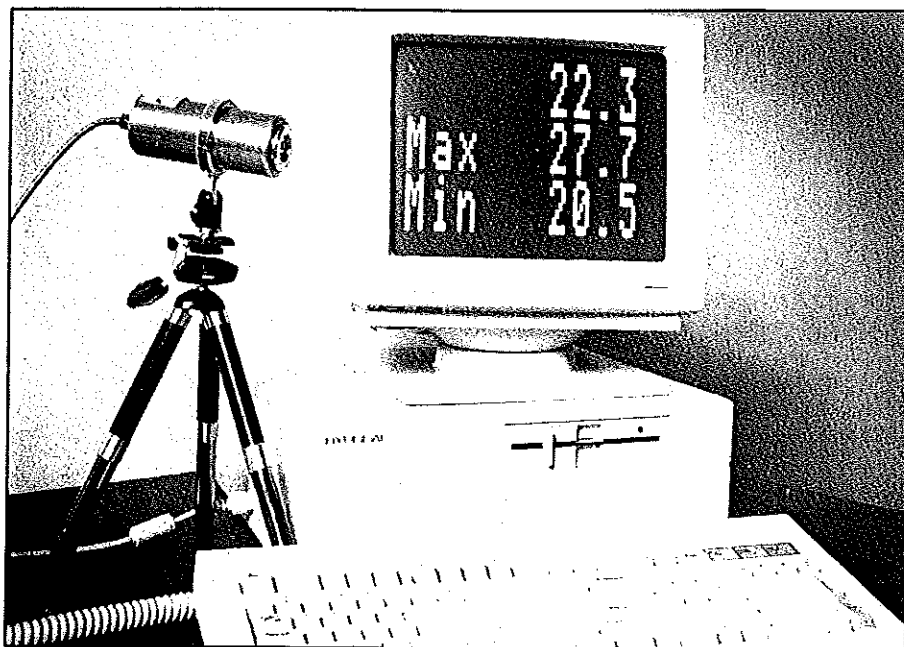

This "smart" temperature transducer provides total linearity correction over the complete temperature range.

The **Model 4000A** microcomputer-based infrared temperature transducer provides for continuous monitoring of several sensors to derive the condition information needed to optimize irrigation scheduling, improve plant or crop production and turf quality, and preserve water supplies. The transducer provides complete linearity correction over the entire temperature range, is optically chopper stabilized, and offers continuous variable temperature compensation. An on-board computer controls all functions. It can be programmed to talk to the host computer either when a reading is out of the "normal" range or at certain predetermined intervals. Standard data transmission is through an RS-232C port, through which a three-digit Emissivity Correction can be remotely controlled. Standard features include peak and valley reading, ten-second moving integral averaging, ambient temperature data, and eight set points with alarms. The patented Lasite Intra-Optical Light Sighting is optional. **Everest Interscience, Inc.**, Fullerton, CA (800) 422-4342.

Flex-Frame Planter is Exceptionally Versatile

The **Model 385** flexible-frame, large-row, crop seed planter is designed to effectively operate in flat, rolling, or contour fields. It can also be used to apply dry or liquid fertilizer, insecticide, and herbicide in tillage conditions ranging from conventional to "no-tillage". The 12-row, 80-in. (2032 mm) frame, which features a pull-type, two-

bar design, hitches to a tractor with the lower links of the three-point hitch. Right-hand and left-hand subframe assemblies are pivotally connected at the frame midpoint by a transverse cross-axle assembly. This assembly, which supports the frame in a road transport position and serves as a pivotal joint for the subframes in field

position, is activated by a hydraulic cylinder anchored on the right-hand subframe. In road transport position, the cross axle is supported by transport wheels and allows for endwise transport of the planter. Because the cross axle — in field position — is the pivotal connection between the right- and left-hand subframes, each subframe follows ground contours. When the cross axle is rotated from its endwise transport position to its field storage position, an automatic latch mechanism fastens the hitch in field position. A truss rod with removable spacer allows the planter beams to flex in field position, and rigidly supports the left-hand subframe in road transport position. Because subframes are offset front-to-rear, overall width in endwise transport is minimized, the tractor is more centrally located in road transport position, and the load is distributed on the cross-axle assembly. The hydraulic system uses two tractor remote circuits — one which raises and lowers the field transport wheels and row markers, and one that activates the hitch, swing cylinder, or cross-axle cylinder. **Deutz-Allis Corp.**, Milwaukee, WI (414) 475-4750).

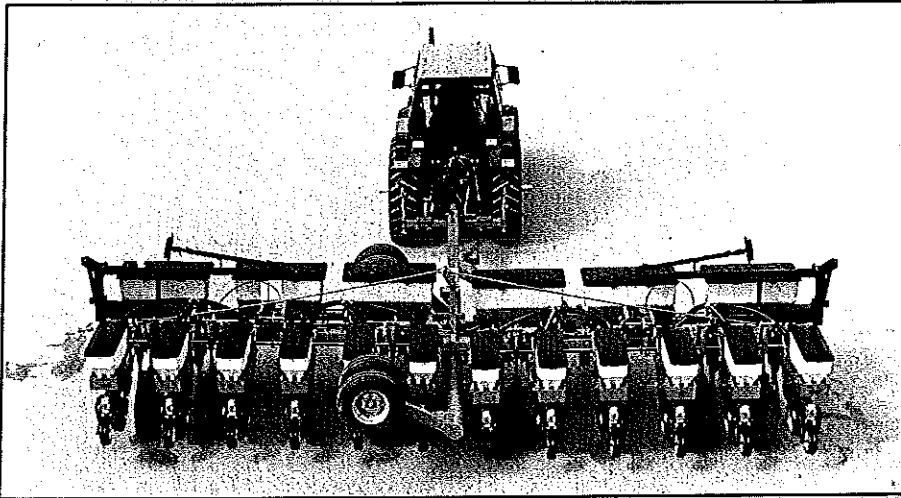

'Super Sweep' Pickup Attachment for Round Balers

The **Wide Converging Pickup Attachment** enables operators of round balers to form exceptionally well-shaped bales with greater end density, resulting in improved storage and handling. It lifts windrows of forage (as large as 68 in. [1727 mm] in width), converges the material, and transfers the narrowed windrow into a baler which has an inside chamber width of 48 in. (1219 mm) or more. Featuring closely spaced teeth, the low-profile, open-ended pickup carries out its sweeping action smoothly and without the material loss that is common with conventional pickups. It is equipped with two 8-in. (203 mm) converging augers, a contoured windguard, and an undershot-balanced, epicyclic, finger-feed packer assembly for material transfer. A factory-installed option on Model 848 and 853 balers, this attachment eliminates the need for add-on "tucker wheel" assemblies that traditionally offer only marginally wider pickup capabilities. **Ford New Holland, Inc.**, New Holland, PA (717) 355-1323.

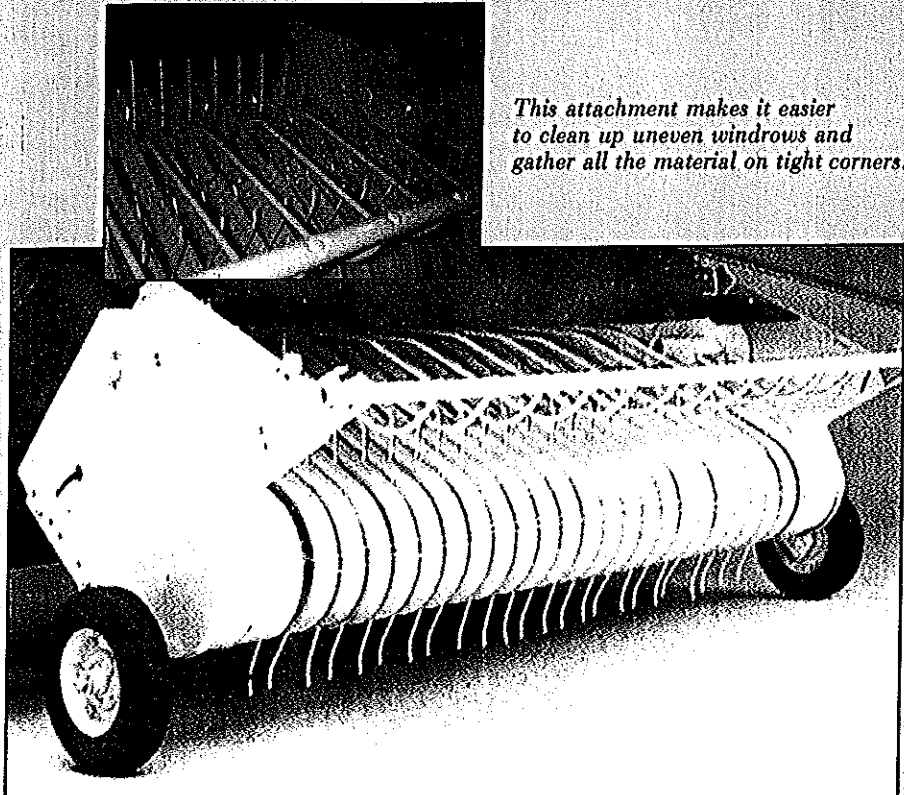

This attachment makes it easier to clean up uneven windrows and gather all the material on tight corners.

Ceramic Spray Tip Resists Corrosion

The TeeJet ceramic (VK) spray tip is designed to provide extended wear in agricultural applications involving the spraying of abrasive and/or corrosive chemicals. It incorporates the VisiFlo design, whereby a ceramic orifice insert is placed in a polypropylene spray-tip body. Molded from an extremely hard mineral-based ceramic material called Korundum, this insert is carefully machined to produce a standard flat fan pattern, which delivers accurate and uniform coverage in broadcast spraying. In comparison with more traditional metallic or polymer structures such as brass or plastic, the TeeJet shows superior resistance to heat and chemical attack. Typical applications include the spraying of pre-emerge surface-applied herbicides at a minimum spray pressure of 30 psi (207 kPa) and post-emerge contact herbicides at typical pressures of 40 psi (276 kPa) and higher. **Agricultural Div., Spraying Systems Co., Wheaton, IL (312) 665-5000.**

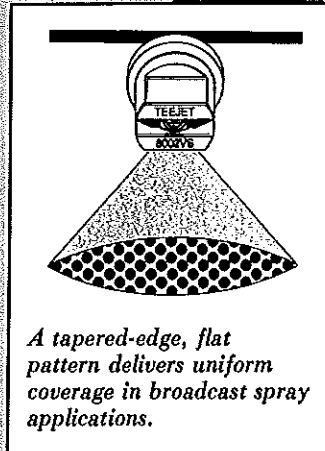

A tapered-edge, flat pattern delivers uniform coverage in broadcast spray applications.

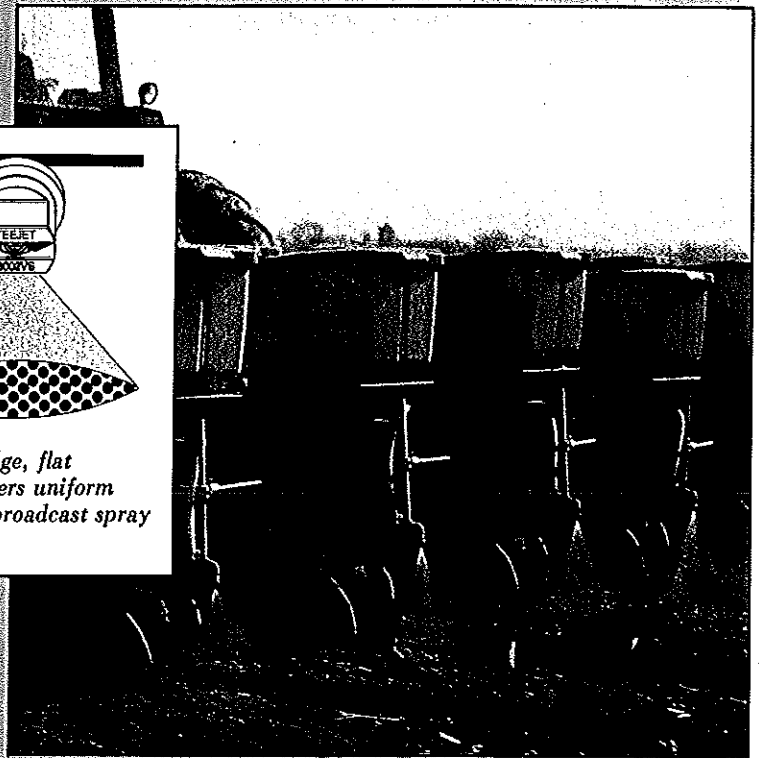

Field Electrical Connector Beats the Elements

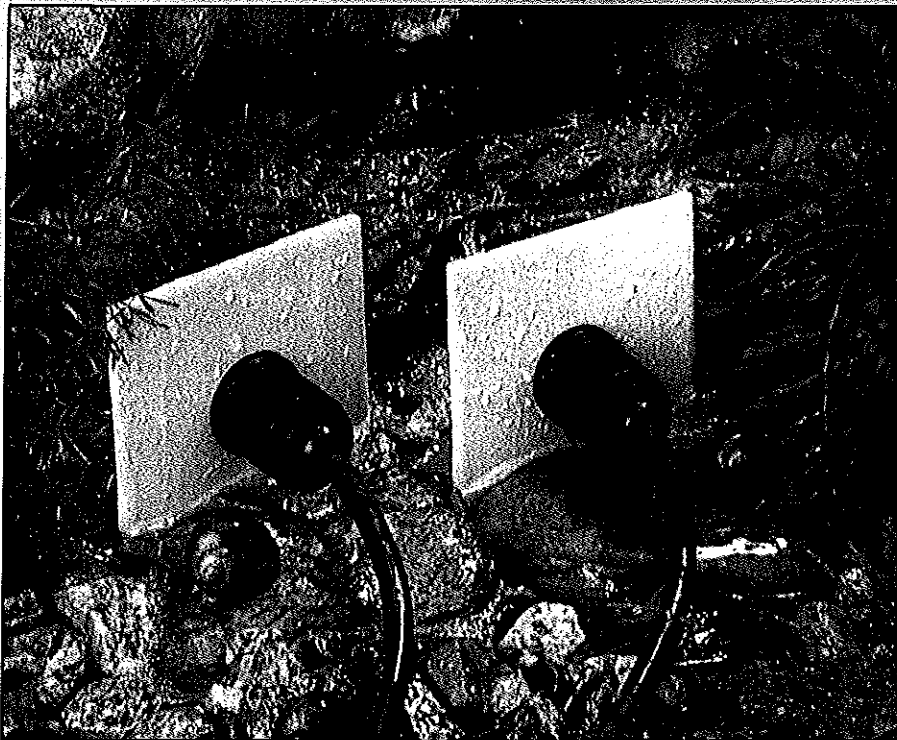

A reliable, multi-featured electrical connection for field electronics and agricultural equipment, the **800 Series Environmental Connector** protects electrical connections and adjacent circuitry from harsh outdoor elements. Its corrosion-resistant, fully submersible, plastic housing — produced through a special insert molding process — encapsulates internal contacts and wiring to protect them from the degrading effects of moisture, ultraviolet rays, chemicals, shock, and vibration. (All exposed components are nonferrous.) The connector is available with one to seven circuits, and can be used in low-level signal, high-current, and high-voltage applications. When fully mated, connector halves lock together, unaffected by shock and vibration. Coupled with the strain-relieved wire exit, the end results are drastically reduced equipment and field-service down times and an interconnect that will outlast the equipment to which it is attached. Its lightweight, economical design provides an alternative to existing military-grade feedthroughs and hermetically sealed connectors. **Andalar Corp., Woonsocket, RI (401) 766-0340.**

Replacement Belt for Failed V-Belt Drives

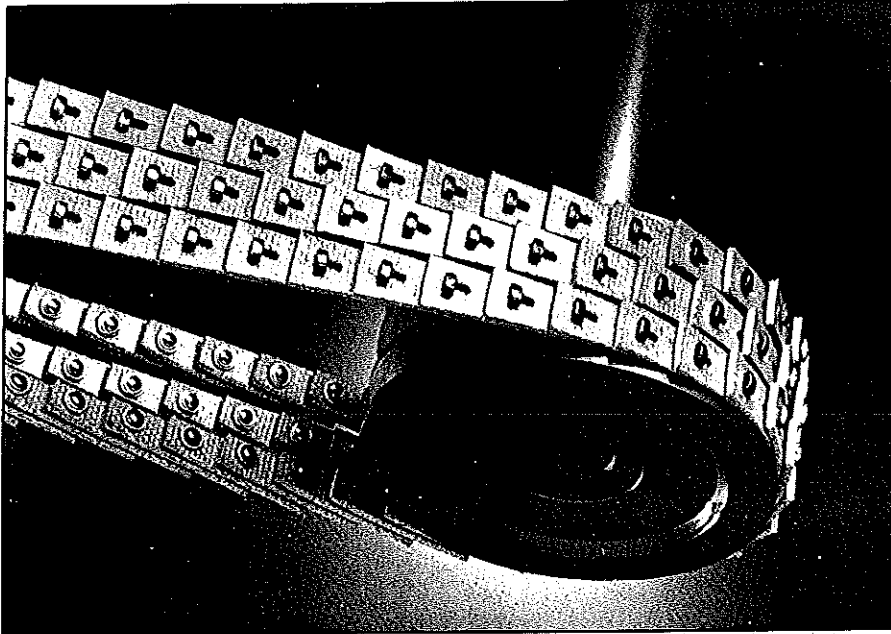

The Nu-T-Link power transmission belt is designed to serve as a replacement belt for failed V-belt drives on agricultural equipment. This belt consists of urethane/polyester composite links fastened with T-shaped studs and offers high resistance to abrasion and shock loading. Links may be added or removed to obtain correct belt length and coupling is accomplished by reversing the procedure. Unaffected by oil, water, steam, and common agricultural chemicals, it will effectively operate in a -40 to 212°F (-40 to 100°C) ambient temperature range. In emergency situations or where access to the drive is limited, the Nu-T-Link can be quickly assembled and installed without dismantling the drive. Available in all fractional and classical belt sections (3L, 4L, 5L, A, B, C, D, and E), this linked-type belt fits all standard V-belt sheaves, and is supplied in 50-ft (15 m) boxed reels for easy storage. **Gates Rubber Co.**, Denver, CO (303) 744-5520.

The belt, the horsepower ratings of which are comparable to classical cross-section V-belts, can be fitted to backside idler drives.

Clog-Free Subsurface Irrigation System

The **Water Spyder** is a multiple-outlet drip irrigation manifold that employs individual and separate ball check valves to meter specific volumes of irrigation water, from 0.5 to 4 gal/h (1.9 to 15 L/h). Water is delivered directly to the plant root structure via subsurface, small-diameter, polyethylene transmission tubing. This subsurface system is less subject to stress cracking and damage by humans, equipment, and environmental elements. It also eliminates both spray damage to structures and injuries traditionally caused by above-ground spitters. The system increases crop yield and quality; conserves water, energy, labor, and chemicals; and reduces percolation of chemicals into the subsoil. Stainless steel 316 nonmagnetic ball valves are coupled with a Celcon-engineered resin casing to eliminate mineral build-up. Pressure-compensating, nonclogging emitters purge themselves each time the system activates. **Rainmate Div., Resource Water Technology**, Somis, CA (805) 482-1720.

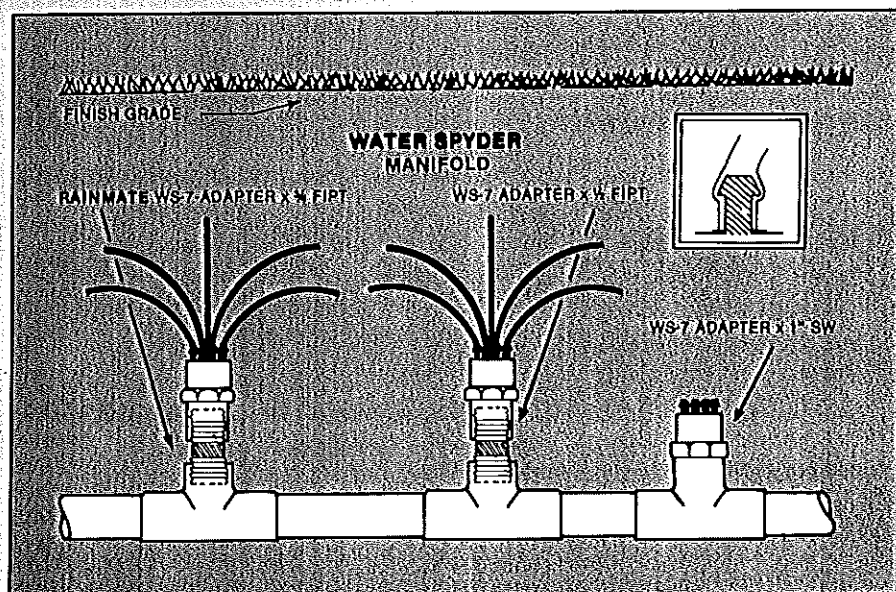

Multiple-outlet, nonclogging, subsurface *Water Spyder* manifolds reduce percolation of chemicals into the subsoil.

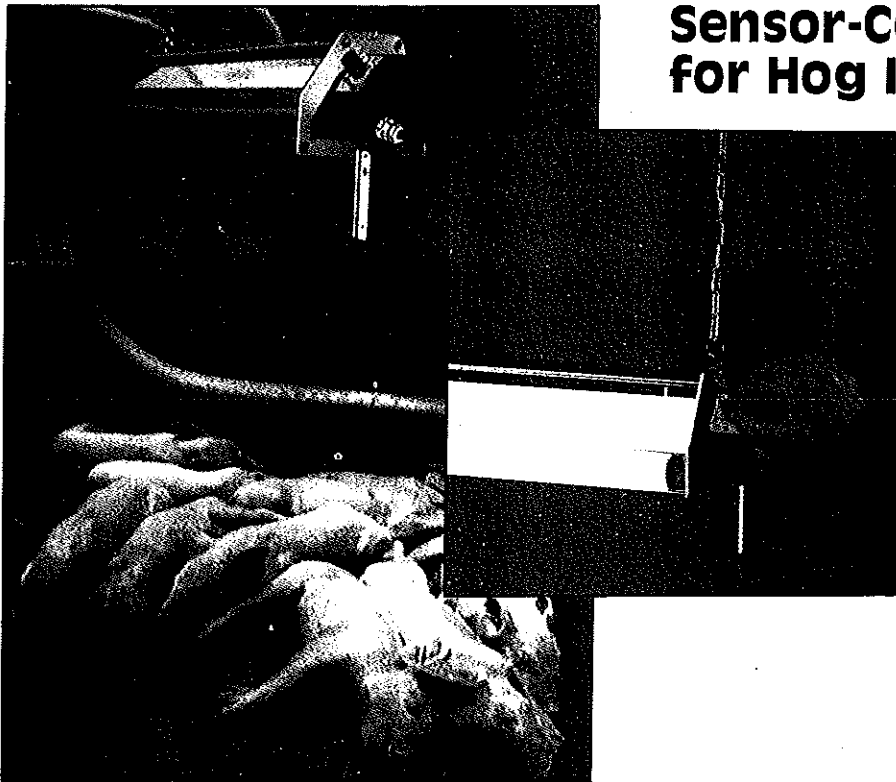

Sensor-Controlled Heaters for Hog Industry

The ceramic infrared heater is a complete closed-loop system with a built-in microprocessor-based control, electronic twist-sensor, and ceramic infrared emitter. The **CTI Heater**, available in 400, 800, and 1200-watt models, was designed specifically for hog farrowing and nursery buildings. Both **Oscar** (gas) and **Marguerite** (propane) versions allow for the setting of different temperatures for different crates or pens, depending on the pigs' age. Temperature can be adjusted to within 0.1°F in each enclosure. True zone heating can be achieved without mechanical means such as Hoover boxes. The electronic twist-sensor measures the temperature actually felt by the pigs. It can be calibrated using preset positions. The ceramic emitter offers 90 to 94% emission efficiency and superior thermal inertia (no sudden temperature fluctuations). The relatively long wave-length (4 microns) of emitted rays creates a soft heat that is acceptable to pigs. **SBM Infrared Heating Inc.**, Fredericksburg, VA (703) 898-1780.

Fertilizer Injector Uses Water-Driven Compressor

This automatic proportioning fluid injector utilizes existing water pressure to operate and inject fertilizer. The water pressure compresses the air in the dual bottom tanks, and forces it into the third (top) tank. The additive (fertilizer) in the tank is then displaced by the air and is forced back into the main irrigation line. A throttling valve enables the user to determine exactly how many parts per million (ppm) to inject. Designed to operate on a single irrigation line with only one control valve, the **PRO-jector** requires no outside power source and has a minimal pressure loss of 2 psi (14 kPa). It has only one moving part, and can be used with drip or conventional sprinkler irrigation systems. **TFS Systems**, Santee, CA (619) 449-6408.

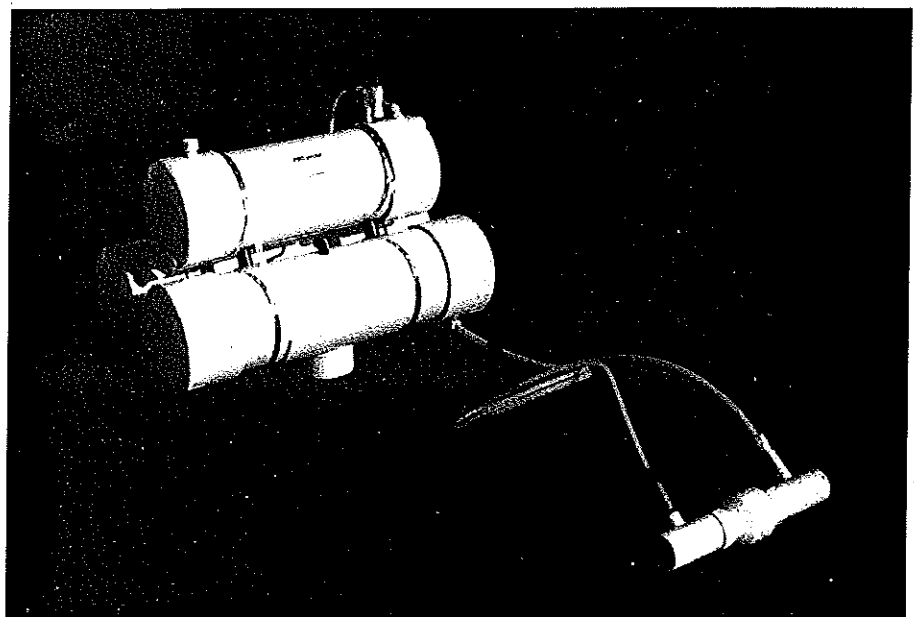

Computerized Respirometer Detects Bacterial Growth

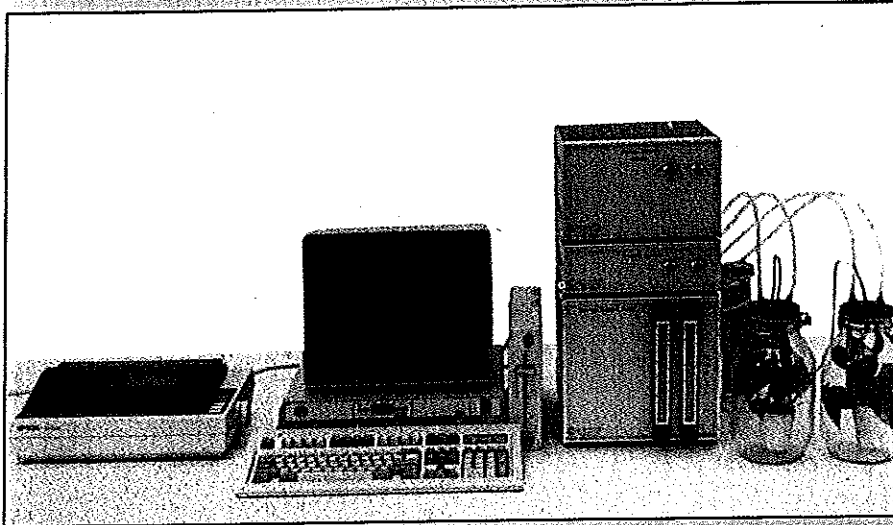

The **Micro-Oxymax** is a multichannel computer that measures oxygen consumption and carbon dioxide production simultaneously in ten chambers. It can be used to detect bacterial infections, insect infestations, and molds in products; to measure agricultural plant and animal metabolism; and to study and measure the aging process of a variety of foods. The computer is relatively immune to temperature fluctuations and provides frequent readings. The automatic respirometer is able to detect changes of 0.2 mL/h. Measurement intervals can be specified between five minutes and 24 hours. The system is controlled by an IBM-PC or compatible computer, and operation is fully automatic with periodic printing and data storage. **Columbus Instruments International Corp.**, Columbus, OH (614) 488-6176.

The system can be expanded to operate with up to ten chambers.

Inverter Shortens Hay Drying Cycle

The combined use of a windrow pickup, angled belt conveyor and inversion chute — to provide inversion on dry ground — results in improved fluffiness and less leaf loss of forage crops. The spring-loaded **Model 144 Windrow Inverter** system also assists the operator when lifting the unit into transport position. Lateral transposition of windrow to dry ground aids in drying. A V-belt section under the conveyor keeps the belt centered on the rollers with minimum adjustment, and a ratchet and pawl tensioning system adjusts the conveyor belt tension. The pickup is protected by a spring-loaded flotation system that allows the pickup to "float" under constant tension over uneven ground. Total drying time is reduced for higher quality and less rained-on hay. **Ford New Holland, Inc.**, New Holland, PA (717) 355-1323.

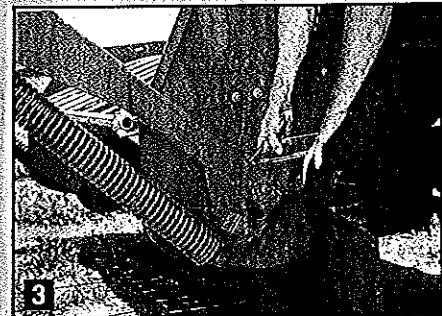
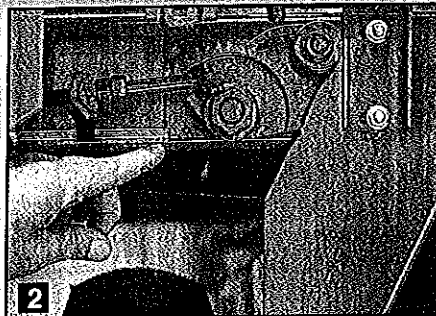
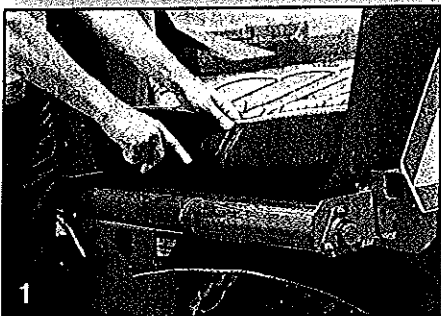
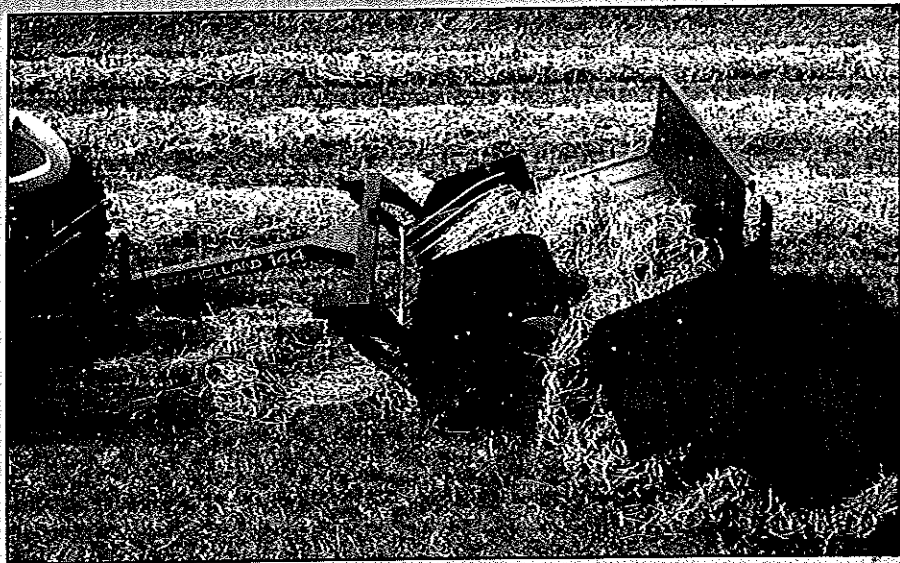



Abbott Interfast Corp.
HYDRA-LOK
Locknut Promises Zero Leakage at Threaded Joints
Page 12

Aeroglide Corp.
PACRITE SPIN COOLER
Water/Air System Keeps Canned Products 'Cool'
Page 18

Andalar Corp.
800 SERIES ENVIRONMENTAL CONNECTOR
Field Electrical Connector Beats the Elements
Page 22

Automata, Inc.
BUG COUNTER
'Bug Counter' Aids in Pest Management
Page 19

Bemis Packaging Service Machinery Co.
PACKER-AID II
Powder/Product Packaging System Automates Task
Page 15

California Pellet Mill Co., Roskamp Division
MODEL 1200 ROLL MILL GRINDER
Energy-Efficient Automated Roll Mill Grinder
Page 6

Campbell Scientific, Inc.
MODEL 012 WEATHER STATION
Weather Station Aids in Crop Management
Page 16

Carbone USA Corp.
ALBUZ CERAMIC SPRAY TIPS
High-Precision Ceramic Spray Tips
Page 13

Carborundum Instrument Technologies Group
CROPLINK
Crop Monitoring System Uses Infrared Telemetry
Page 19

Case IH
MODEL 8469 HAY BALER
Hay Baler Features Electronic Controls
Page 9

J. I. Case
MODEL 5600 & 5700 CHISEL PLOWS
Chisel Plows for Conservation Tillage
Page 13

Chore-Time Equipment
ULTRAFLO FEEDER
'Stress-Less' Feeder Increases Egg Production
Page 5

Chore-Time Equipment
H2 FEEDER
Poultry Feeding System Uses Centerless-Core Auger
Page 11

Ciba-Geigy, Agricultural Division
FARM-PAK CS
Herbicide Handling System Reduces Human Exposure
Page 4

Columbus Instruments International Corp.
MICRO-OXYMAX
Computerized Respirometer Detects Bacterial Growth
Page 25

Container Machinery Corp.
STERISTAR RETORT LINE
Thermal Processing Retains Natural Product Qualities
Page 14

Curtis Tractor Cab, Inc.
TUCK-AWAY HEATER
Compact Heater Keeps Tractors on the Job
Page 18

John Deere Des Moines Works
MODEL 750 NO-TILL GRAIN DRILL
Drill Adds Versatility to Seeding Operations
Page 8

John Deere Des Moines Works
OPERATOR PRESENCE SYSTEM
Picking Unit System Increases Operator Safety
Page 17

Design Analysis Associates, Inc.
HYDRONET
High-Precision Outdoor Data Logging System
Page 7

Deutz-Allis Corp.
MODEL 385 SEED PLANTER
Flex-Frame Planter is Exceptionally Versatile
Page 21

Dynamax, Inc.
DYNAGAGE
Gauge Measures Sap Flow in Crops
Page 16

Electrostatic Spraying Systems, Inc.
ELECTROSTATIC SPRAYER
Electrostatic Sprayer Increases Chemical Coverage
Page 17

Everest Interscience, Inc.
MODEL 4000A TEMPERATURE TRANSDUCER
Microcomputer-Based Infrared Temperature Transducer
Page 20

Ford New Holland, Inc.
ACCUCUT
Advanced Forage Harvester
Page 5

Ford New Holland, Inc.
RECTANGULAR HAY BALERS
High-Capacity Rectangular Hay Balers
Page 10

Ford New Holland, Inc.
OPERATOR RESTRAINT SYSTEM
Electronics Enhance Operator Safety
Page 15

Ford New Holland, Inc.
WIDE CONVERGING PICKUP ATTACHMENT
'Super Sweep' Pickup Attachment for Round Balers
Page 21

Ford New Holland, Inc.
MODEL 144 WINDROW INVERTER
Inverter Shortens Hay Drying Cycle
Page 25

Full Vision, Inc.
QUAD-FLEX
Versatile Material Handling Attachment
Page 4

Gates Rubber Co.
POLY CHAIN GT
Tough-Toothed Belt Cuts Equipment Downtime
Page 7

Gates Rubber Co.
NU-T-LINK
Replacement Belt for Failed V-Belt Drives
Page 23

Highway Equipment Co.
NEW LEADER MODEL L-1000
Spreader Promises Uniform Fertilizer Application
Page 00

Key Technology, Inc.
COLORSORT
High-Volume Automatic Food Sorting System
Page 10

Melroe Co.
MODEL 230 SPRA-COUPÉ
Lightweight, High-Speed Ground Sprayer
Page 12

Omnidata International, Inc.
700 SERIES POLYCORDER
Hand-Held Computer Records High-Speed Analog Data
Page 11

Resource Water Technology, Rainmate Division
WATER SPYDER
Clog-Free Subsurface Irrigation System
Page 23

SBM Infrared Heating Inc.
CTI HEATER
Sensor-Controlled Heaters for Hog Industry
Page 24

Spraying Systems Co., Agricultural Division
TEEJET CALIBRATION CALCULATOR KIT
Calculator for Accurate Chemical Application
Page 8

Spraying Systems Co., Agricultural Division
TEEJET CERAMIC SPRAY TIP
Ceramic Spray Tip Resists Corrosion
Page 22

Sundstrand-Sauer
SERIES 40 M35 HYDROSTATIC TRANSMISSION
Custom-Built Transmission Adds Design Efficiency
Page 6

TFS Systems
PRO-JECTOR
Fertilizer Injector Uses Water-Driven Compressor
Page 24

Walterscheid, Inc.
MODEL K64 CUT-OUT CLUTCH
Cur-Out Clutch Offers Overload Protection
Page 9

White Hydraulics Inc.
HB/MOTOR BRAKE
Geotor Motor Brake Adds Design Versatility
Page 14