



The Agricultural Engineering

50

Outstanding innovations
in product or systems
technology during 1985-86

Saluting the AE 50

Acceptance in the marketplace is the highest accolade any new agricultural product can ever receive. But for innovative developments introduced in the last 12 months, a singular honor is to be named one of the Agricultural Engineering 50 outstanding innovations in product or systems technology.

Showcased over the next 31 pages are 50 top engineering developments in agriculture introduced since mid-1985. Virtually all companies making products for food and agriculture were eligible to submit for consideration "developments that embody the application of new technology or the innovative application of an older technology."

Hundreds of "product nominations" vied for coveted spots among AE's Top 50. A distinguished panel of engineering experts from three well-known organizations reviewed entries to select those considered most likely to make "worthwhile contributions to the advancement of engineering in agriculture."

Agricultural Engineering magazine is proud to play an important part in making known these significant developments in the production, processing, research, storage, packaging, and transportation of agricultural products. To all firms — and especially to you winners — here is our AE 50 Salute for 1985-1986.

ADJA Industries Ltd.

Gas-charged foam markers for wide sprayers

Aerovent Fan & Equip. Inc.

3-part environment control for structures

Agwatronics Inc.

Porous ceramic senses soil-water tension

Air-Way Mfg. Co.

Flared hydraulic fitting with O-ring seal

Paul Beckman Company Inc.

Noninvasive radical device senses fluid flow

Case IH (Tenneco Co.)

Airflow conveyor & cotton picker dump basket

Case IH (Tenneco Co.)

Tractor/implement link measures true acreage

Caterpillar Tractor Co.

Track-type ag tractor for drawbar loading

Cat Pumps Corp.

Stainless steel plunger pumps for food plants

Curtis Instruments Inc.

Low-power chip-based dc unipolar integrator

Custom Products

Litchfield Inc.

Auger-mounted grain cleaner with blower

Drossbach Agro-Drip Inc.

Internally spiralled channels in dripper tubing

Dutton-Lainson Co.

Truck-bed winch system for big round bales

Eaton Corp.

Controls Div.

Electronic travel speed and acreage monitor

Everest Interscience Inc.

Infrared thermometric device detects crop stress

Flowtech Inc.

Multitrotor vane-type pump with variable ports

Fulton Thermal Corp.

Coil-type heat exchanger with isotropic fluid

Gandy Co.

Speed-compensated meter for air-blown granules

Gillis Ag Systems Inc.

Remote-sensor control of variable-speed fans

Hancor Inc.

Bacteria growth-resisting drainage tubing

High Lifter Water Systems

Pressure-intensifier pump for irrigation systems

H. D. Hudson Mfg. Co.

Knapsack sprayer with 360 deg valve

Hutchinson Div.

Lear Siegler Inc.

Full-loop filler/unloader for grain bins

Irrigation Systems Co.

of Western Colorado

Horizontal butterfly-actuated irrigation valve

Irrigation Technology Corp.

Low-pressure diaphragm-type irrig regulator

Johnson Div.

Signal Environ. Sys.

Large-slot cylindrical screens for irrigation wells

Kornylak Corp.

Ag. Systems Div.

Rough-terrain fork truck straddles fruit bins

Nacom Industries Inc.

Machined plastic drain valves for chemicals

North American Green Inc.

Biodegradable erosion-control blankets

Numonics Corp.

Software-driven plotter for eng drawings

Oliver Mfg. Company Inc.

Gravity separator with fiberglass suspension

Omron Electronics Inc.

Photoelectric sensors for monitoring robots

PT Components Inc.

Noncontacting speed sensor for elec motors

Performance Products Inc.

Venturi device injects chemicals in sprinkler

Quadrastat Corp.

Joystick-actuated cable control for hyd valves

Rhino Robots Inc.

Robotic workcell aids teaching, R&D tests

SBM Infrared Heating Inc.

Microprocessor-controlled heaters for piglets

SPOT Image Corp.

Digital & photographic output from satellite

Saf-T-Cab Inc.

Fold-over frame for roll-over protective structure

Solar Tracking

Systems Pty. Ltd.

Parabolic sun-tracking collectors heat water

Sprayrite Mfg. Co.

Propeller-assisted delivery of sprayed pesticides

Sun Star Systems AB

Roof-top solar collector connects to grain dryers

Tico Industries Inc.

Flow-adjusting emitter for trickle irrigation sys.

Trickle Soak Systems

Pressure differential-actuated fertilizer injector

Tye Company

Double-gang drill tightens row spacings

Vaisala Inc.

Thin-film polymer sensor & humidity transmitter

Valcor Scientific

Div. of Valcor Eng.

Solenoid-actuated pump has isolated diaphragm

Vermeer Manufacturing Co.

Self-steering control system for big-round balers

Weasler Engineering Inc.

Spring-loaded locking collar for pto drivelines

Year-A-Round Cab Corp.

Deep-working chisels for moldboard plows

Two-Part Tube Senses Fluid State

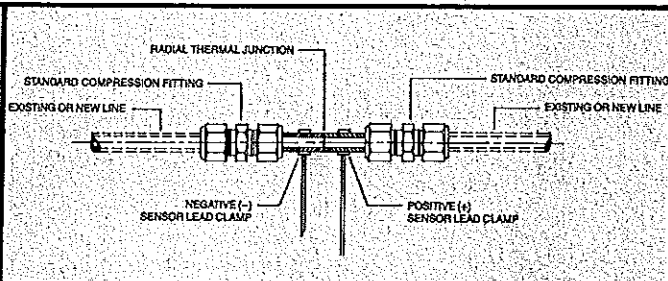
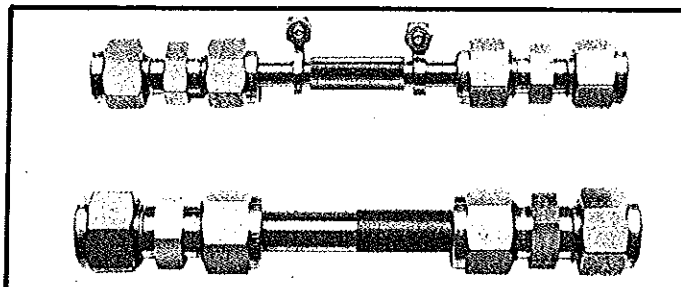
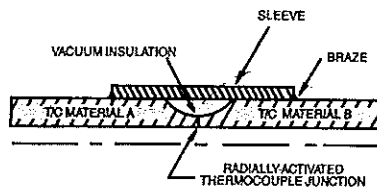

Temperatures and flow rates inside piping systems are sensed by a non-invasive device developed by Paul Beckman Co. Inc., Elkins Park, PA. Consisting of two fusion-welded tubes of standard thermocouple materials, the device forms a radially activated junction that serves both as a pressure vessel and as a temperature sensor. An extremely fast response rate to temperature changes is attributed to the device's radial nature and its intimate fluid contact. Also, the in-line device preserves a sealed, aseptic, and sterilized environment for piped fluids.

Flow-Tapping Injector Adds Plant Food

Pressure differential between main and auxiliary pipes is tapped to operate a device for injecting wet or dry fertilizer into drip-type and conventional irrigation systems. The secondary flow is created by diverting part of the main flow and mixing it with fertilizer. This mixture is controlled with throttling valves as it is fed back into a system's main stream. A 1-gal PVC tank holds the fertilizer in injectors built by Triple Soak Systems.

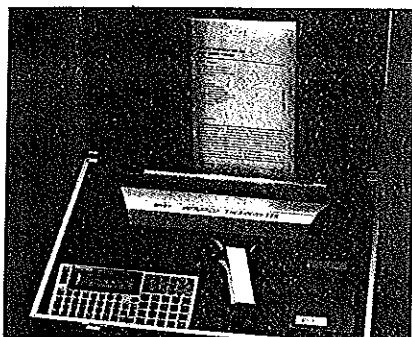
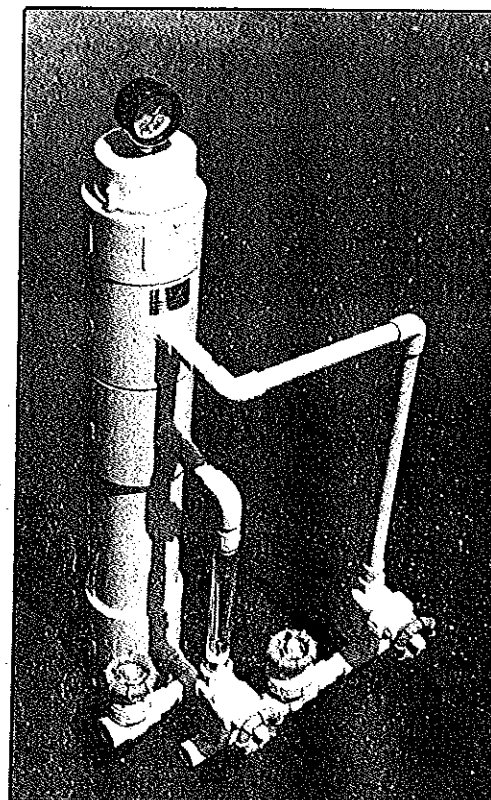

New Crop Water Stress Indicator Kit, Infrared thermometry based system, helps to optimize irrigation scheduling and improve crop yields enabling fast, real-time measurements of crop water stress in the field.

The kit consists of a "chopper stabilized" Agri-Therm Infrared Thermometer, a humidity sensor and probe and a computer with serial interface adaptable to RS-232C.

Relative humidity, dry bulb and crop canopy temperatures are measured by the humidity sensor and the Agri-Therm, respectively. The computer is programmed to compute CWSI in the field.



1120 S. Raymond Ave., Fullerton, California 92631
(714) 992-4461 or (714) 730-0747
Telex No.: 295368

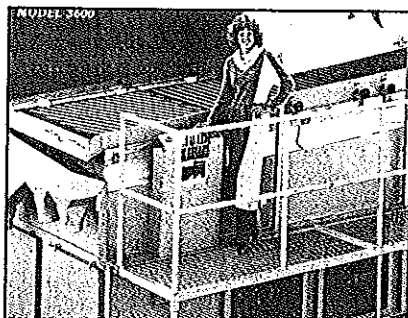

Oliver Maxi-Cap Gravity Separator possess several new unique design features. An improved rectangular deck assures product separation at greater capacities than any other gravity separator. Computer designed multiple fans generate a controlled volume of air allowing for accurate density grading. Conveniently mounted easy-to-use hydraulic controls, an Oliver exclusive, give the operator the flexibility required to guarantee profits. Send us a sample of your product, and take advantage of our free lab service, and computer analysis of the results.



Oliver Manufacturing Company, Inc.
P.O. Box 512
Rocky Ford, Colorado
81067 U.S.A.
Telephone (303) 254-7813

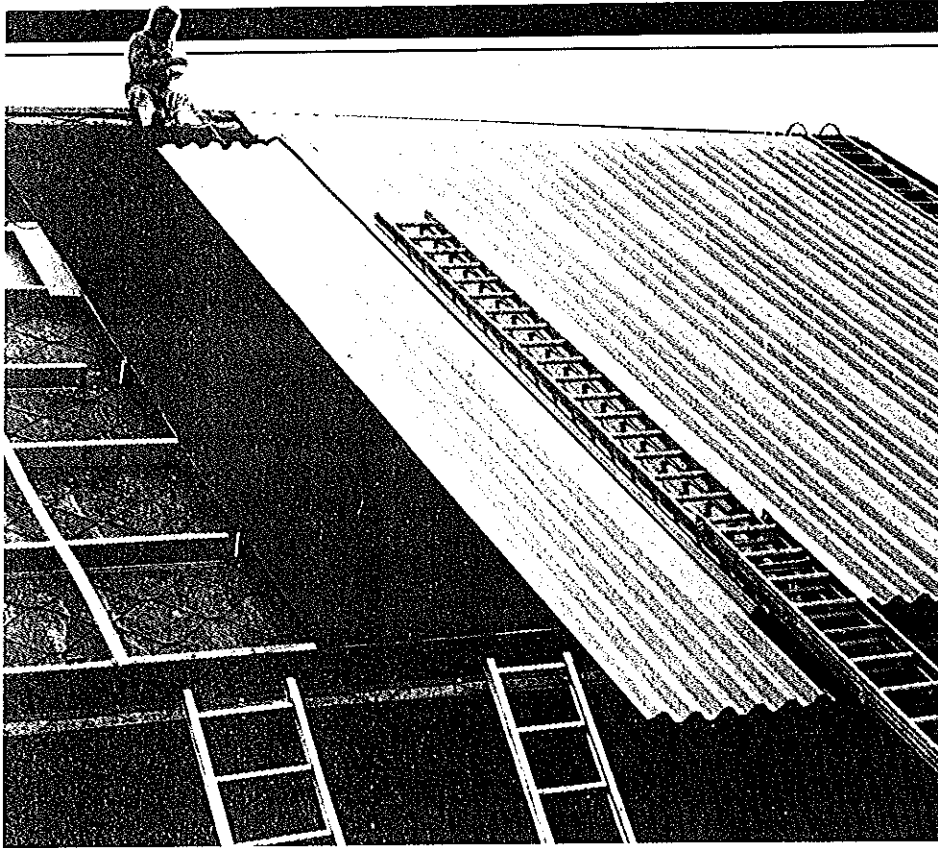

Low-Cost Collector Aids Grain Drying

Roof-top solar collector heats passing air for routing to internal (or nearby) structures that contain grain, hay, and commercial products. Developed in Sweden and used in other Nordic countries before its U.S. introduction, the roof-top design consists of blackened panels made from recycled textile fibers. An energy-absorbing mat can be mounted on any existing roof structure, including leaky barn, shed, or warehouse roofs in need of repair. Trapped air spaces are then covered with a corrugated plastic sheeting, reports Mark Stimson, Sun Star Systems AB, Stockholm, Sweden. A U.S. marketing arm of the same name is located in Davis, CA.

Flared Fitting Gives Three-Point Sealing

Hydraulic fitting machined with a 37-deg flare prevents leakage through three-point contact of an enclosed elastomeric O-ring seal within a triangular space, claims Air-Way Mfg. Co., Olivet, MI.

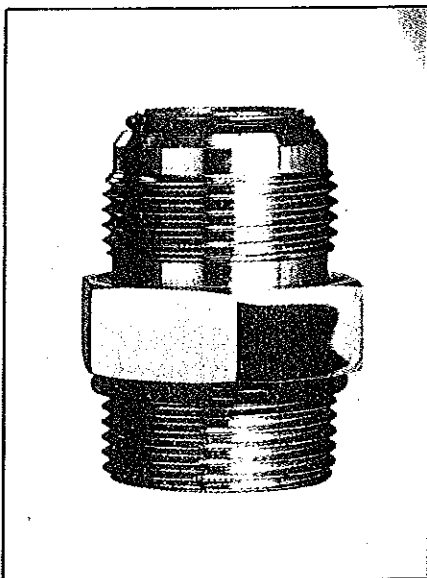

Precision Pumps Handle Harsh Chemicals

Stainless steel components and fluoroelastomer seals are combined in plunger-type pumps built to maintain sanitary conditions in food-process plants as well as withstand harsh corrosive chemicals in other applications (such as 2,000 psi fertilizer injection). All wet-end parts are made of No. 316 stainless steel, reports Cat Pumps Corp., Minneapolis, MN. Pump drive ends boast a forged nitrited chrome-moly crankshaft, stainless steel plunger rods, Zamak crossheads and connecting rods, and tapered roller bearings.

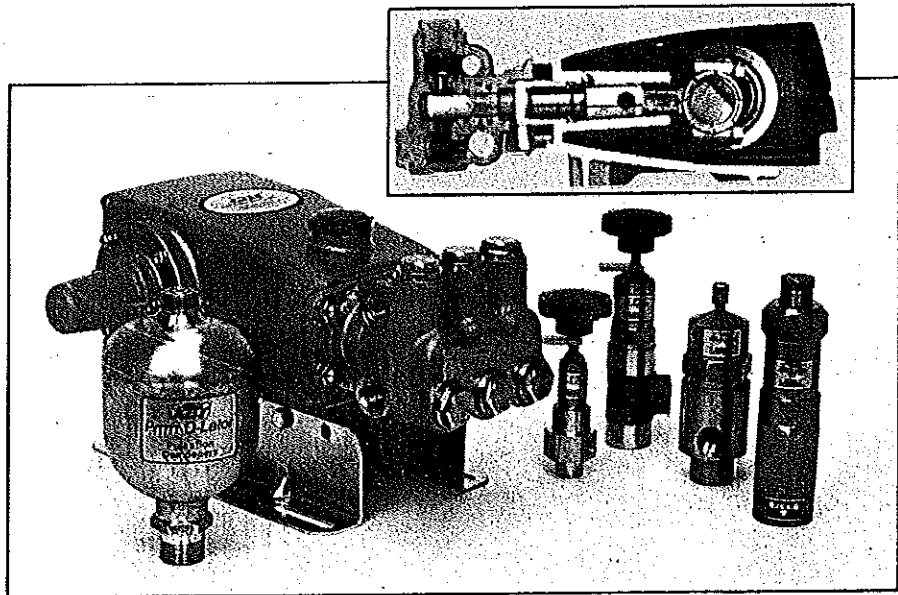

Bondioli & Pavesi Advances PTO Technology.

As a technology driven corporation, Bondioli & Pavesi uses careful research and design, backed by state of the art production techniques, to produce PTO drive shafts and torque limiting devices of exceptional quality. And we have

the largest range available.

So no matter what your design problem, you can count on Bondioli & Pavesi for the solutions that combine outstanding engineering, durability and innovation. The technology that puts your equipment a cut above the competition.

We're ready to turn your design problem into a PTO advance that improves the performance and value of your equipment.

A UNIQUE DRIVE SHAFT CONFIGURATION. Inspired rounded-triangle design allows an easy, precise fit, transmits torque over a greater contact area, resulting in reduced vibration and thrust loads.



HEAVY-DUTY CONSTANT VELOCITY JOINT. Opens up new design possibilities for machines operating at extreme angles and protects against equipment damage vibrations.

BONDIOLI & PAVESI

Bondioli & Pavesi, Inc.
104 Sycamore Drive, Ashland, Virginia 23005
(804) 798-1565 • Telex 827-303

Revamped Tractor Design Meets Tillage Requirements

A track-type tractor built specifically for heavy drawbar loads in agriculture is now available from Caterpillar Inc. (formerly Caterpillar Tractor Co.), Peoria, IL. The new AG 6 is configured to accommodate the dynamic (front-to-rear) weight transfer that occurs with primary tillage tools, and to give much greater ground-contact area than previous track-type tractors. The combined result of various design improvements is increased tractive effort, higher travel speeds, greater vehicle stability, and reduced soil compaction. In fact, Caterpillar cites pressure isobar plots that now favor track over wheel "foot prints" — even when compared with today's big four-wheel drive units having dual tires. These improvements are said to derive from four major changes relative to a D6D SA tractor: 1. 20 in. longer track-roller frame. 2. 38 in. longer vehicle main frame. 3. 11% increase in ground-contact area per track (to 5,424 in.²). 4. 38 in. forward relocation of the radiator, engine, clutch, fuel tank, and operator's station.

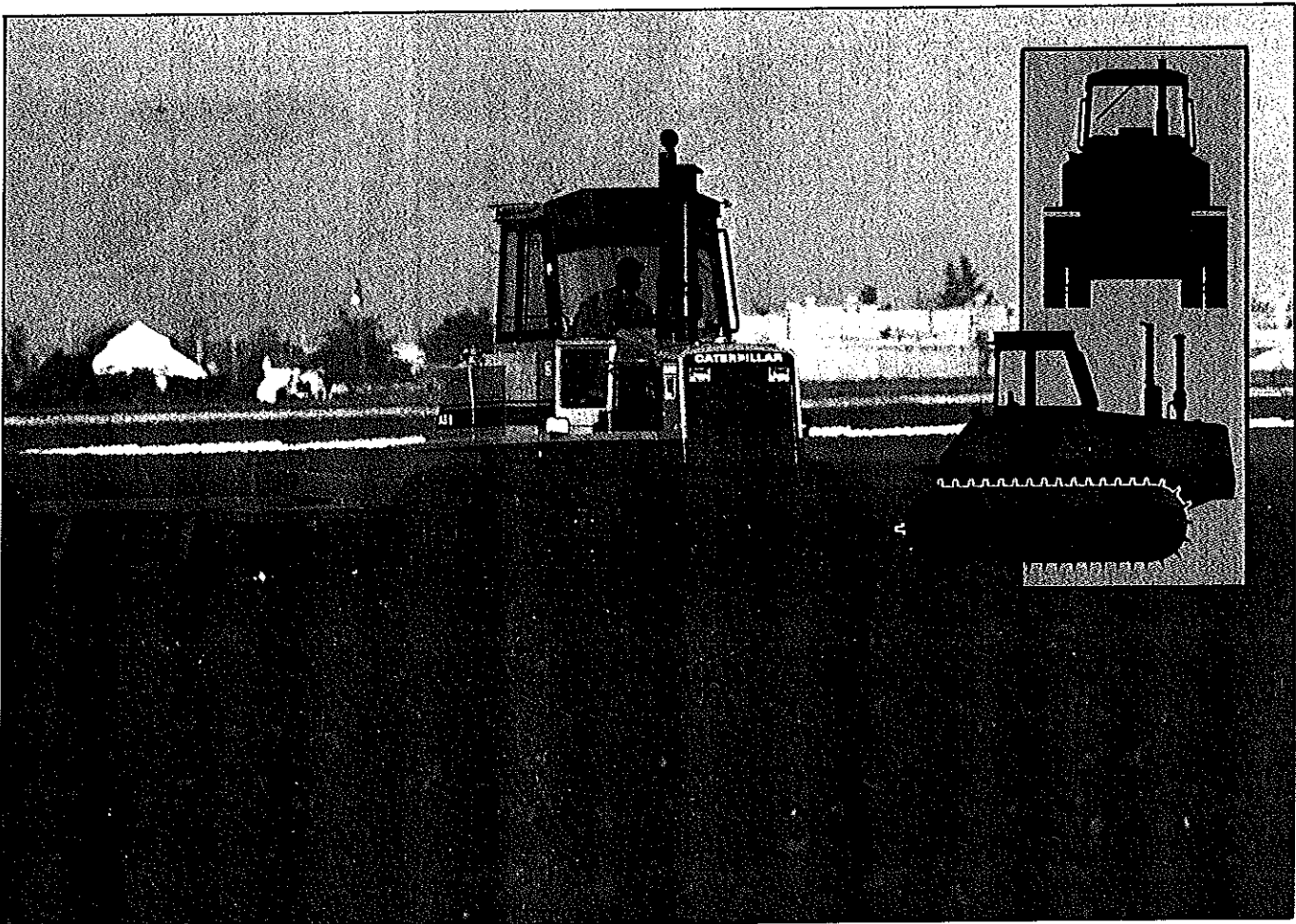
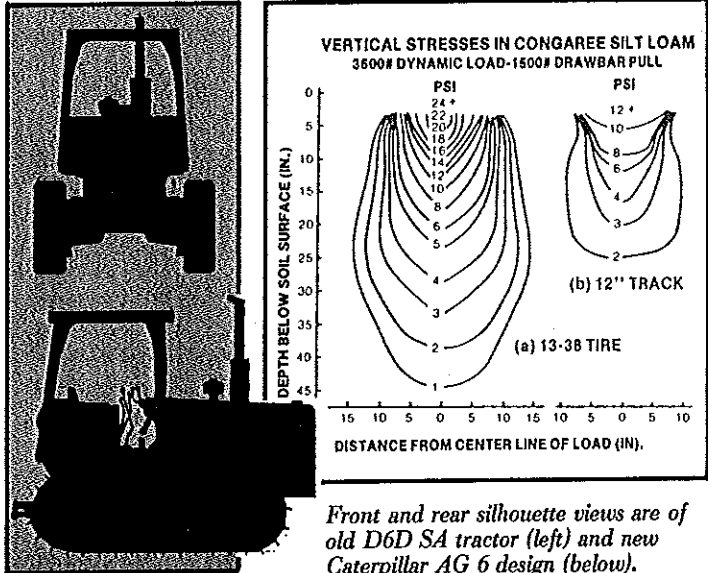

Screen Geometries Boost Well Efficiency

Increased water flow and reduced pumping costs are attributed to a well screen made from V-shaped wire placed in hoop-like fashion on vertical steel rods. This arrangement forms a continuous-slot screen claimed to give more open area than conventional bridge slot, louvered screen, and slotted pipe designs for irrigation well inlets. Moreover, the new borehole screen presents minimal restrictions to water flow and it is not prone to blockage by soil and/or gravel particles. These features translate into shallower lifts for irrigation pumps, says the Johnson Div., Signal Environmental Systems Inc., St. Paul, MN.

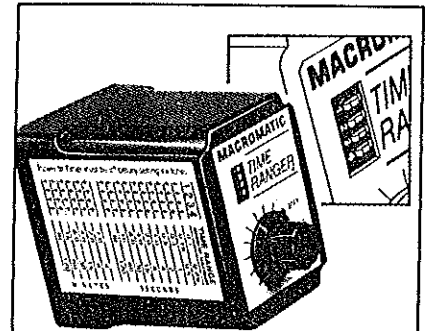
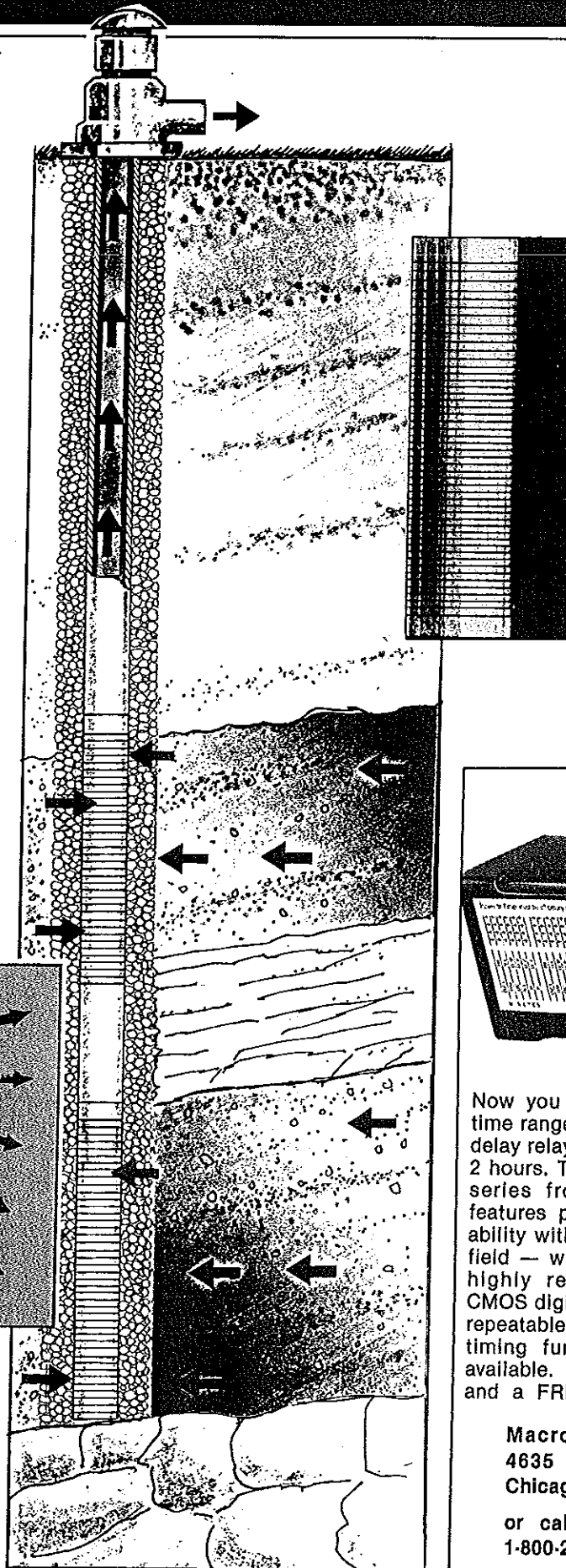
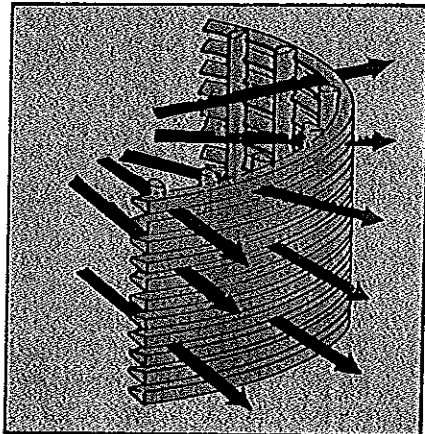

Now you can have 16 separate time ranges within a single time-delay relay — from 0.1 second to 2 hours. The "TIME RANGER™" series from Macromatic, Inc. features pin-for-pin interchangeability with timers already in the field — without re-wiring. These highly reliable units feature CMOS digital circuitry with 0.5% repeatable accuracy. All standard timing functions and voltages available. For more information and a FREE 90-day trial, write

Macromatic, Inc.
4635 W. Lawrence
Chicago, IL 60630

or call TOLL-FREE
1-800-237-3762 Ext. 824

Foam Dispenser Shows Swath Width

An aerosol-type foam replaces soap bubbles for marking the swath width of wide-boom sprayers and big implements. Built by ADJA Industries Ltd., Calgary, Alberta, the new marking technique is based on a disposable, precharged canister of foam, 100 ft of hose and wiring harness, two solenoid valves, discharge nozzles, and funnel cups. ADJA president Dennis Poffenroth says that balls or stripes of dispensed foam remain visible "for at least one full day."

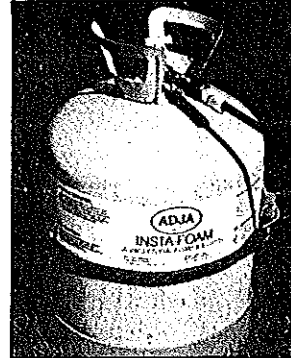
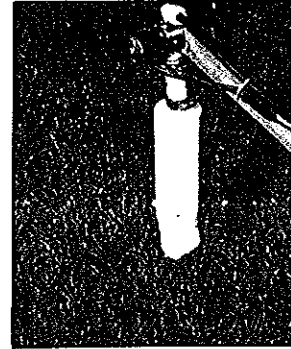
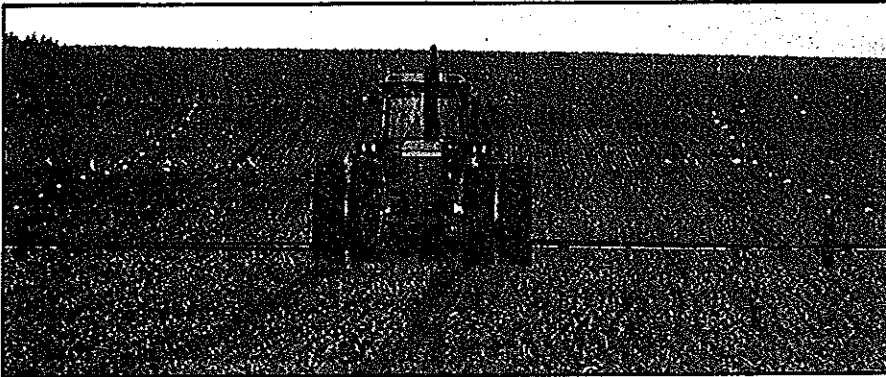

Integrated System Aids Environmental Control

Previously separate elements are integrated in a three-part environmental control system offered by Aerovent Fan & Equipment Inc., Lansing, MI. The firm's so-called "stage manager" control system consists of a master console, remote temperature sensors, and digital-display/adjustment-knob control. Overall system can accommodate up to 13 temperature set points for controlling fans and other equipment located in livestock structures and greenhouses, reports Aerovent's Robert M. Mitchell.

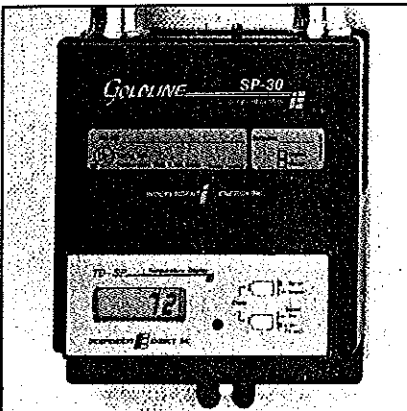

GOLDLINE SP-30 electronic temperature control is ideally suited for agricultural, greenhouse, dairy, food processing and storage applications. Featuring ± 1 °F temp accuracy, adjustable setpoint range (-26 °F to 200 °F) and adjustable differentials (1 °F to 25 °F) these controls far surpass the limitations of traditional cap & bulb controls. Mount sensor up to 1000' from the control for easy installation and application flexibility. Snap in TD-SP module for digital display and monitoring. SP-302 two-stage controls also available. For further information call INDEPENDENT ENERGY, INC., POB 1305, E. Greenwich, RI 02818 1-800-343-0826.

INDEPENDENT ENERGY INC.

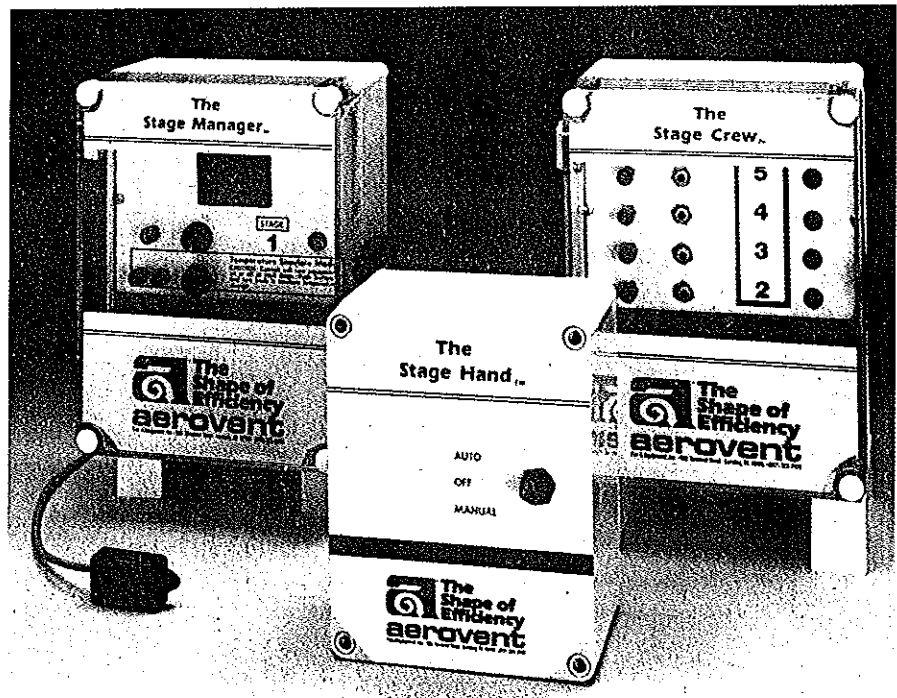

Sun-Tracking Troughs Make Water Boil

Heat-pipe technology is incorporated in roof-top solar collectors that heat circulating water for greenhouses, domestic water systems, and supplementary grain dryers. The sun-tracking parabolic collector troughs are made from a polished Alcan 557 alloy. Reflected solar rays are concentrated on an evacuated longitudinal copper pipe that — in functioning as a heat pipe — terminates inside a central water-storage tank. This patented design is even claimed to bring water to a boil without requiring an alternate power booster, reports Solar Tracking Systems (Australia), Strathpine, Queensland.

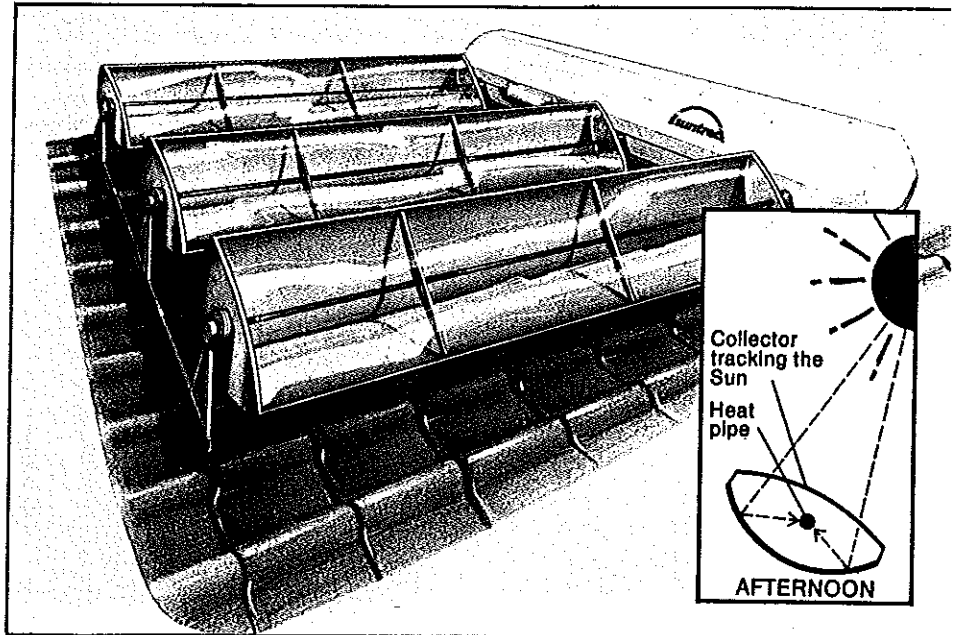

Water-Miser Tubing Has Integral Drippers

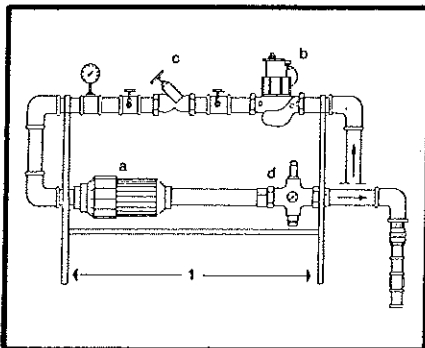

Irrigation dripper units are integrated at 33 to 132-cm intervals along the 2-mm thick walls of corrugated polyethylene tubing. The unique lateral-distribution pipe features spiral channels — each with a 1.8-mm² cross-section — formed between its inner and outer walls. Water discharge rates correlate directly with channel length, reports Drossbach Agro-Drip Inc., Los Angeles, CA. Following tests in Scandinavia, the spiral-channel tubing has begun to find use in U.S. vegetable fields, greenhouses, and tree nurseries. New tubing conserves water, eliminates dripper connections, and resists plugging by calcium, iron, and other particles.

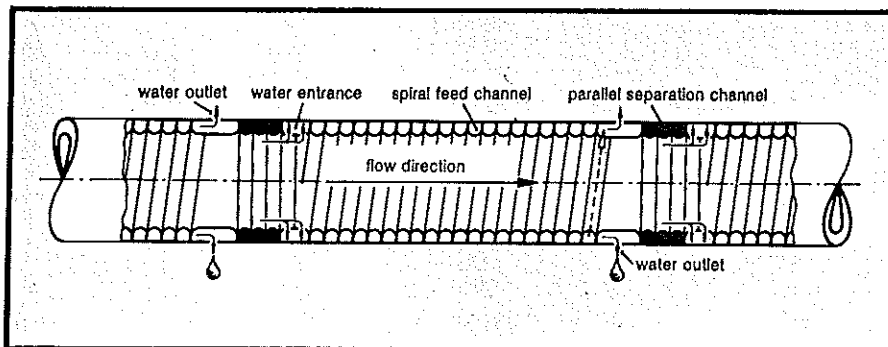

High Efficiency Pressure Balanced Pumps

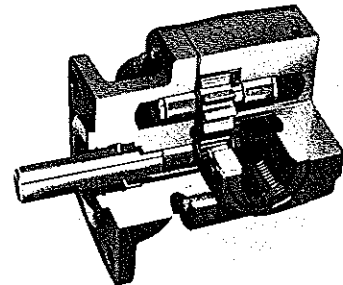

New Pressure Balanced Hydraulic Pumps deliver up to 90% overall efficiency. Their unique, modular design allows you to specify a combination of features and integral valve options. Displacements from 0.065 to 0.711 cu. in., continuous pressures to 3000 PSI, speeds to 5000 RPM, and flow rates to 11 GPM at 3600 RPM are available. Constructed of heavy-duty cast iron with hardened steel gears, these high efficiency pumps are particularly suited for agricultural equipment applications.

John S. Barnes Corp.
POB 6166
Rockford, IL 61125
(815) 398-4400

Low-Power Chip Integrates DC Data

Solar irradiance is measured with a Dc unipolar integrator that operates on less than 1 mA and requires an analog input signal of 0 to 100 mV. The modular semiconductor generates a pulse-train output in counts per hour which are calibrated for maximum rates of 500, 1,000, 2,000, or 4,000. Fitted with an appropriate transducer, the integrator can be used to monitor activities such as electrical, pressure, noise, and radioactivity, say spokesmen for Curtis Instrument Inc., Mt. Kisco, NY.

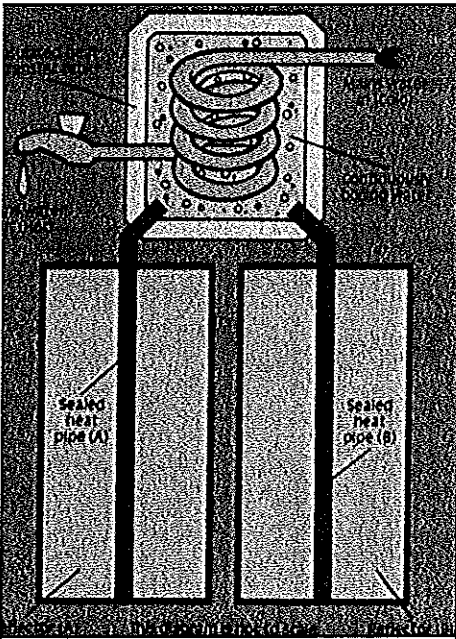
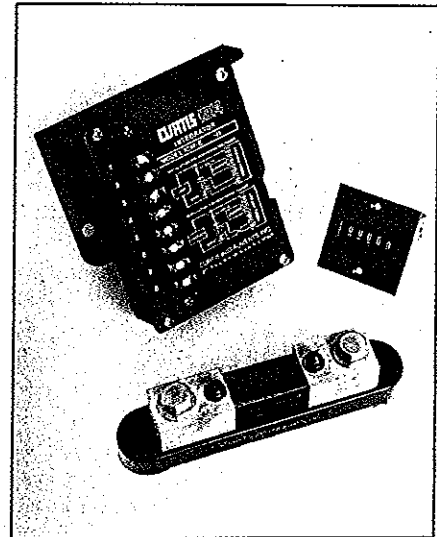

Tandem Units Tighten Row Spacings

Ultrathin 4-in. spacings between drilled seed rows permit fairly intensive production of cereal grains. Because seeding mechanisms can be crowded only so close, two sets of gangs are employed in a staggered yet tandem configuration. This arrangement accommodates the double-disc opener, fluted metering wheel, and press/depth-control wheel needed for each row unit while attaining drill spacings of 4 or 6 in. and up, reports the Tye Co., Lockney, TX.

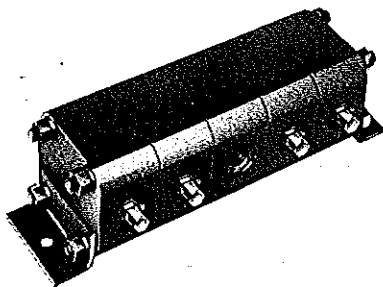
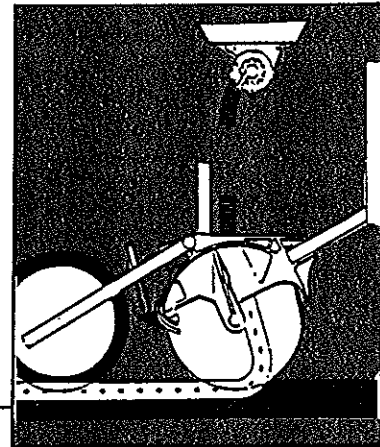

Rotary Flow Dividers

Rotary Flow Dividers provide synchronized operation of multiple cylinders or fluid motors, proportional division of pump output among several circuits, or for intensification circuits. They require no maintenance and are made with rugged cast iron and steel materials. Input flow rates from 2 to 20 GPM, and pressure differentials from 1200 to 3000 PSI are available. These Flow Dividers are available in multiple sections and are particularly suited for agricultural equipment applications.

John S. Barnes Corp.
POB 6166
Rockford, IL 61125
(815) 398-4400

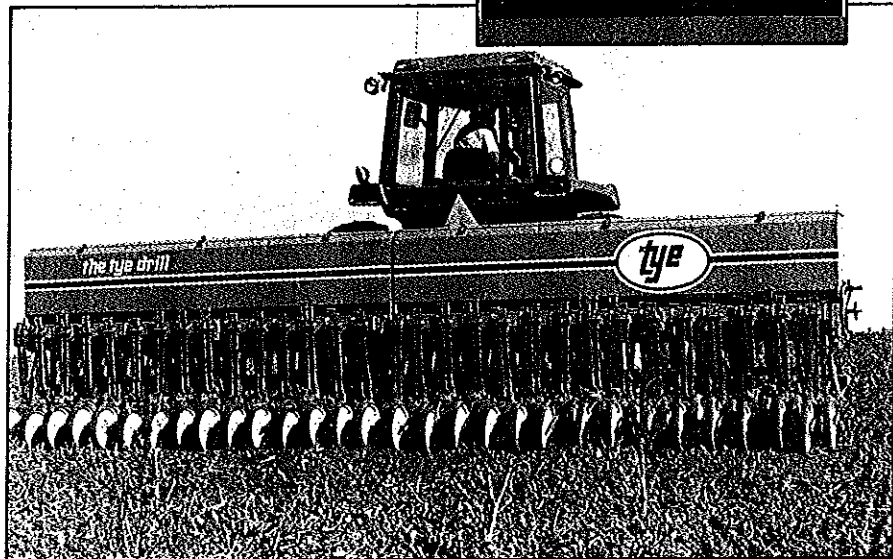

Infrared Thermometric Device Detects Crop Stress

One electronics set multiplexes up to eight infrared temperature transducers in a crop/water-stress detection kit built by Everest Interscience Inc., Tustin, CA. Capable of reading both true and apparent foliage temperatures, the system includes a humidity probe, meter, and calculator. The result is a compact, low-cost design providing continuous monitoring of crop-canopy temperatures, real-time irrigation feedback control, and closed loop control of vegetation temperatures. Accurate monitoring of surface temperatures in crop canopies helps to optimize irrigation scheduling and the overall production of field crops. This technology is now being extended to landscape and turf-grass areas, reports Charles E. Everest.

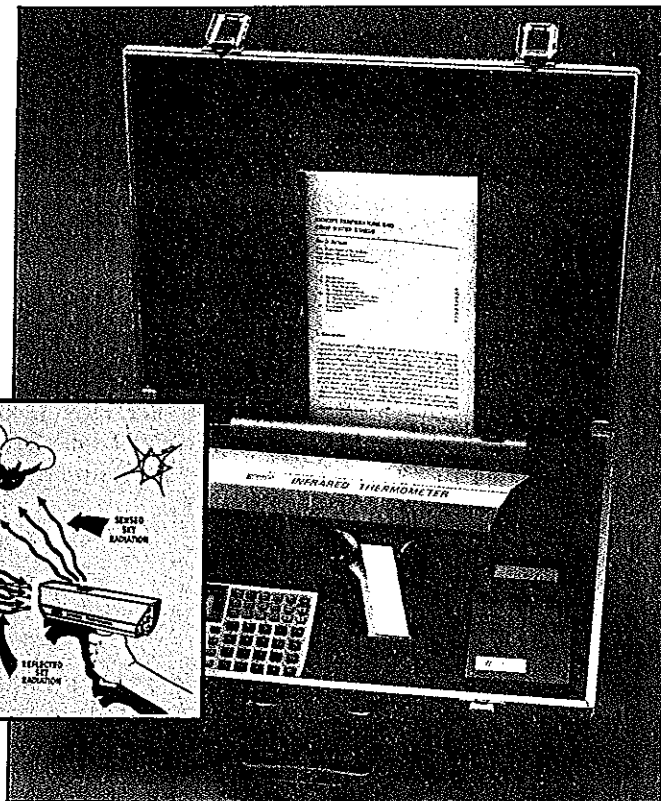
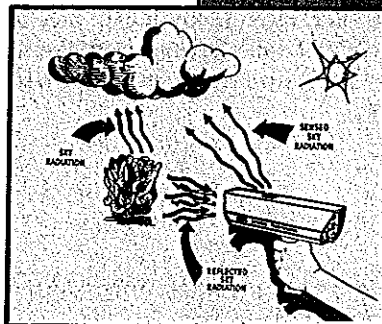

Give Farm Chores A New Lift

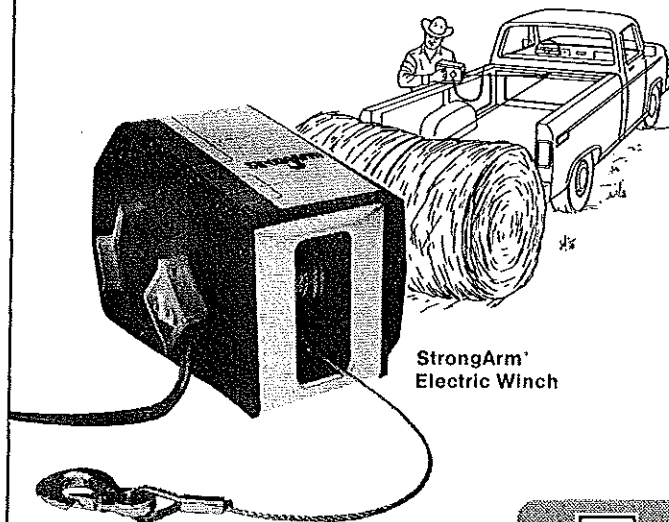

StrongArm[®]
Electric Winch

Let D-L Feed and Grain Handling Equipment Handle the Tough Jobs

Whether you're moving bales, augering grain or hoisting heavy loads, D-L has the feed and grain handling equipment to take the work out of the toughest jobs.

Ask for your **FREE D-L Catalog** for complete information on the following product lines:

- Electric Winches
- Brake Winches
- Worm Gear Winches
- Grain Probes

Made with Pride in the U.S.A.

1886

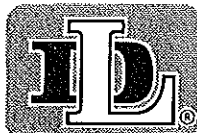

1986

Put Our 100 Years Experience
to Work for You!

DUTTON-LAINSON COMPANY

P.O. Box 729 • Hastings, NE 68901 • (402) 462-4141 • Telex 9106240451

Electronic Switch Cures Motor Ills

A solid-state device replaces conventional centrifugal starting switches in single-phase ac motors. Built onto a printed-circuit board, the noncontacting sensor and switch package eliminates the problems of sparking, shock, vibration, dust, moisture, and corrosion that often plague electromechanical devices. Developed by the Stearns Div. of PT Components Inc., Milwaukee, WI, the speed-sensitive electronic switch has a cut-out speed of 75 to 85% of a motor's synchronous speed. Reclose occurs at about 50% of synchronous speed. Anticipated agricultural applications for motors with the new switches include silo unloaders, bulk tank agitators, milking machines, irrigation pumps, and feedlot conveyors.

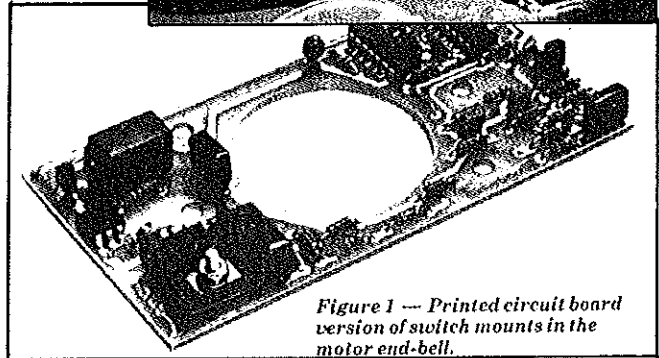
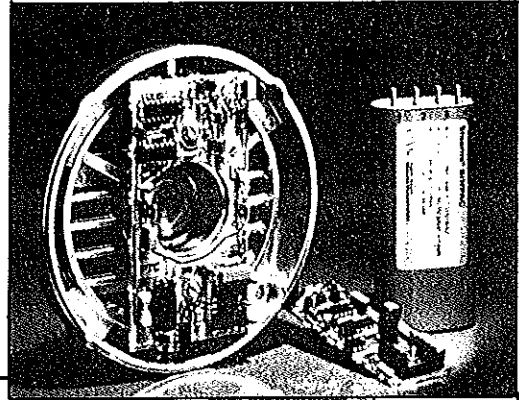
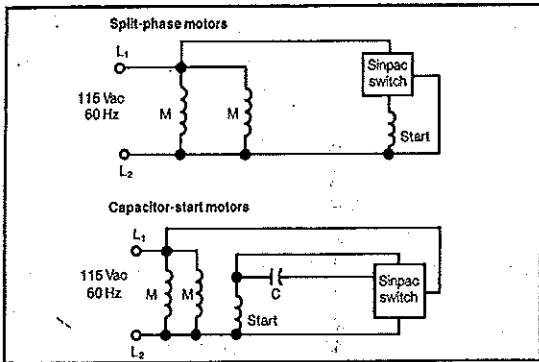
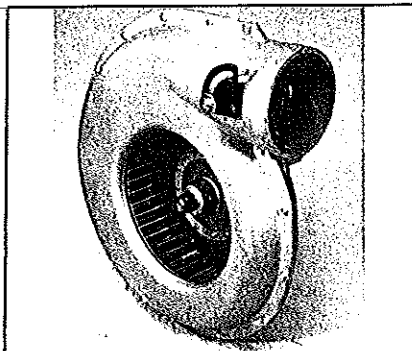



Figure 1 — Printed circuit board version of switch mounts in the motor end-bell.



Crary Hi Pressure Forward Curve Fan was originally designed for agricultural applications. The Crary Fan has the flexibility, dependability, and affordability to become a valuable asset to your agricultural, commercial or industrial operation. It has high performance in an affordable, compact, lightweight package, and wide range of pressure and airflow through fan RPM or butterfly control. It is a durable dust- and vibration-proven design.

For ordering or more information call:
U.S. 1-800-247-7335

Crary Co.
P.O. Box 1779
Fargo, ND 58107



WIND AND TEMPERATURE

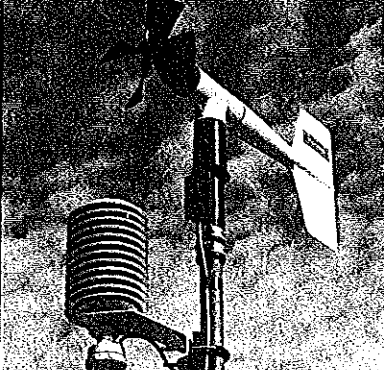

WIND INSTRUMENTS
Professional quality sensors for field applications in air pollution, wind power, agriculture, forestry, aviation...

TEMPERATURE INSTRUMENTS
Aspirated and naturally ventilated radiation shields & sensors for accurate temperature measurement...

DIGITAL DISPLAYS
Easy to read digital displays with recordable outputs for wind speed, peak gusts, direction, variability, temperature, dew point and delta T.

R.M. YOUNG COMPANY
2801 Aero Park Drive
Traverse City, Michigan 49684 USA
Phone (616) 946-3980 TWX 810-291-3366

Drainage Tubing Has Bug-Fighting Agent

A bacteria-inhibiting compound incorporated in plastic tubing prevents the growth of iron ochre or iron sludge. This unwanted growth often plugs the holes and slits in drainage tubes, then renders them ineffective. The new 'bug-proof' tubing is available from Hancor Inc., Findlay, OH in diameters of 4, 5, 6, and 8 in. According to Hancor, the bacteria-inhibiting agent is approved by the EPA as being non-toxic and environmentally safe.

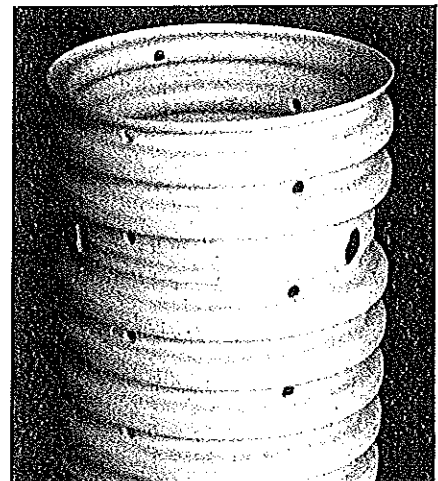

EFFICIENT POWER in new RE Series Motor

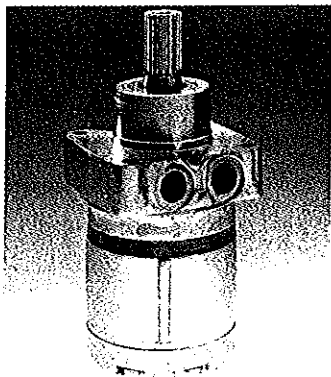

RE Series motors produce high volumetric efficiency due to modification of the wear plate located between gerotor and end cover. Improved performance results from high pressure oil directed between the wear plate and end cover which creates minimum operating clearance for the rotor.

Offered in two configurations, operating pressures have been increased from 2000 psi to 3500 psi (with factory approval); resulting from design improvements in the laminated manifold plate.

Applications include combine reel drives and header reversers; fork lift truck wheel drives, turf equipment, garden tractors, roto-tillers; packaging palletizers and banders.

White Hydraulics Inc.
Box 1127
Hopkinsville, KY 42240
(502) 885-1110

Full-Loop System Fills, Unloads Bins

Rectangular loop of auger-like tubing connects a drive-over inlet hopper, gravity-drop fill ports, sweep-arm unloading augers, and vertical discharge spout for a series of grain bins. Constantly moving through the loop of tubing is a chain and circular paddle-type conveyor. This patented arrangement enables one top corner-drive unit to power the closed-loop system during grain loading, unloading, and recirculating. Plastic conveyor paddles are spaced 13-in. apart and housed in 6 or 8-in. diam tubing, reports Hutchinson Div. of Lear Siegler Inc., Clay Center, KS.

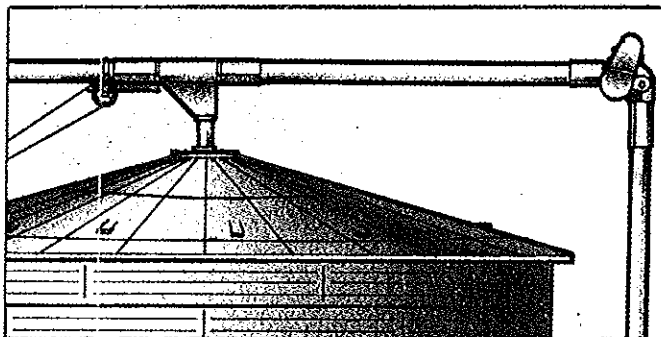
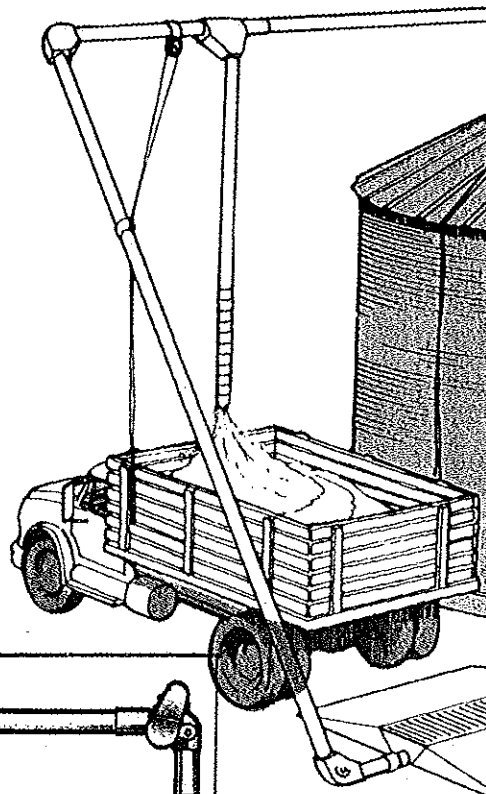

Disposable Blankets Make Seed Stay Put

Photodegradable netting and biodegradable straw are teamed in special "blankets" that control erosion and conserve moisture on newly seeded slopes and ditches. The natural materials are uniformly dispersed across a 6-ft width, then "stitched" into a thin layer that fosters vegetative growth. Thus constructed, the 83-ft long blankets can be rolled for handling and transport. Only one or two persons are needed to unroll blankets and staple them to the ground. According to the developer, North American Green Inc., Evansville, IN, blankets are offered in several types that include netting on one or both sides, use of coconut reinforcing fibers, and seeded versions.



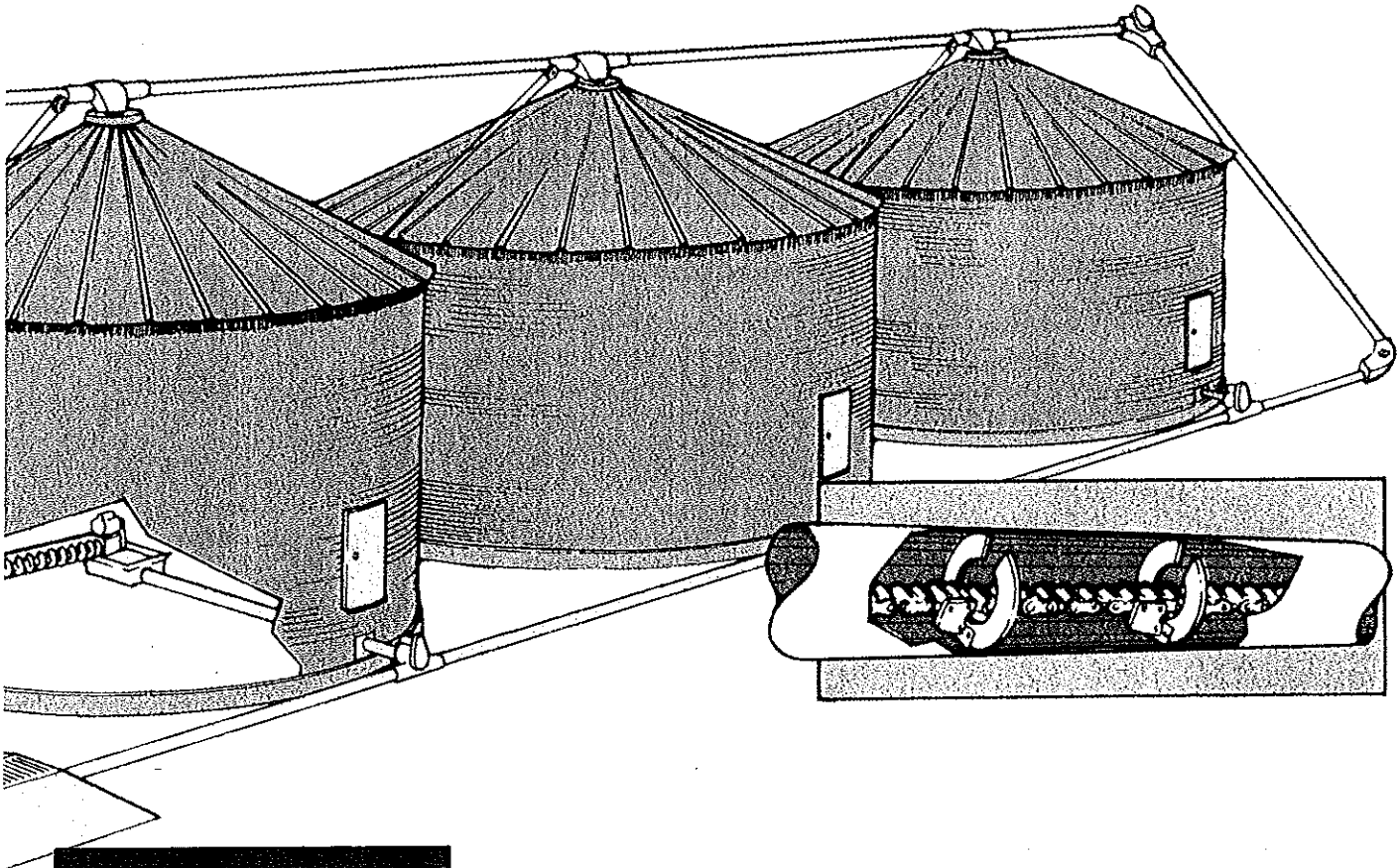

Wire & Metal Specialists

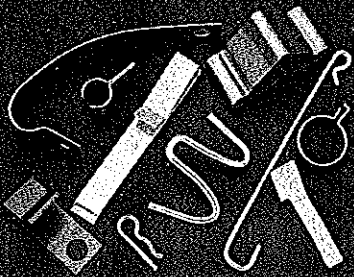

Fourslide Production. Fast, economical with low tooling costs. Nilson ribbon and wire Fourslides and U.S. Baird Multi-Slides.

Wire: up to .187" diameter. Ribbon: up to 2 1/2" wide.

- Engineering and design assistance
- Prototype services available
- Statistical process control
- Modern 80,000 sq. ft. plant. Complete tool room with latest technology in wire EDM.

See Our Catalog in
Thomas Register's

THOMCAT

KMCTM

KICKHAEFER MANUFACTURING CO.

1235 S. Park Street Port Washington, WI 53074
(414) 284-3424

Serving Industry Since 1908

Composite Collar Secures Drivelines

Connections between implement drivelines and tractor pto shafts must permit rapid installation and prevent accidental release. These conflicting needs are resolved with an improved locking device featuring inner steel ring that is partially encapsulated with a high-density polyethylene collar. This spring-loaded metal-and-plastic combination resists wear, cuts device weight, lowers costs, and extends design life. Weasler Engineering Inc., West Bend, WI.

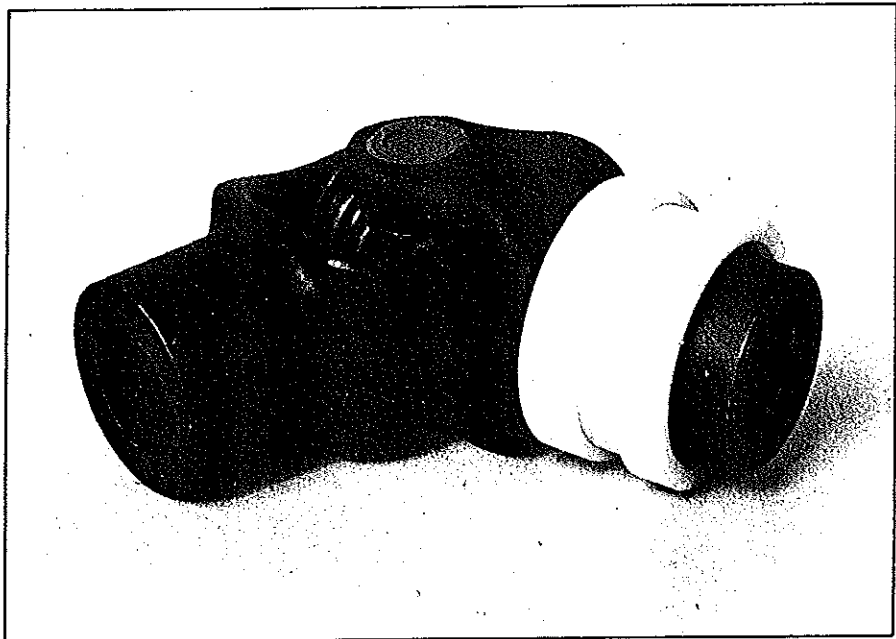

In-Line Device Regulates Irrigation Water

Pilot-aided diaphragm operates at low pressure when used as a regulation valve in irrigation lines. Built from ABS and Delrin polymers, the valve handles 20 to 75-psi inlet pressures and is available for outlet pressures of 6, 10, 12, 15, 20, and 25 psi. Claimed to be surge (or hammer) resistant, the in-line regulator has a valve-return spring, interchangeable outlet-control device, and provision for minor field adjustment, reports Irrigation Technology Corp., Sun Valley, CA.

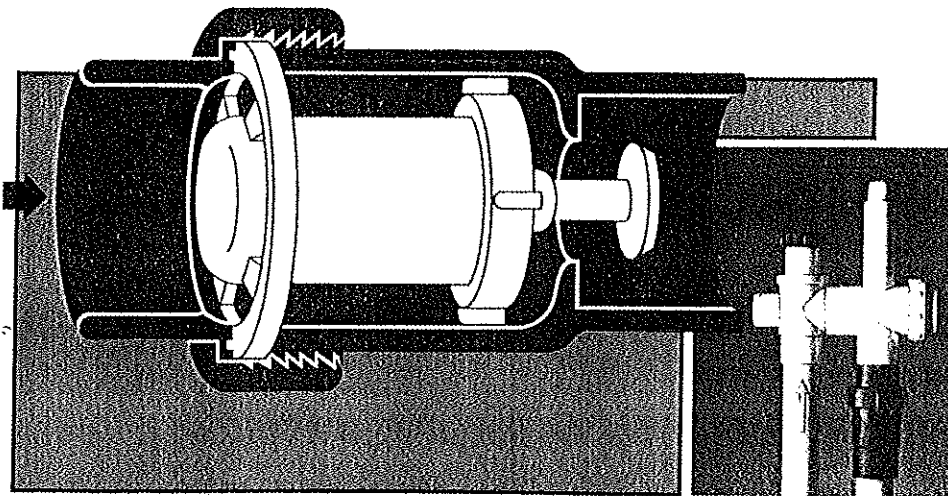

PORTABLE PUMPING

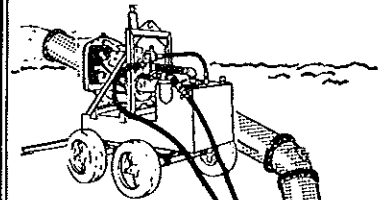

If you have a need for a high volume rugged submersible pump - check out our line of portable hydraulically driven axial flow pumps. Pumps are available from 500 GPM all the way to our thundering 100,000 GPM 60" discharge. Write or call today for more information.

(305) 426-1500



M&W PUMP CORP.
33 N.W. 2nd STREET
DEERFIELD BEACH,
FLORIDA 33441
TELEX 51-9272

Bypass Loop Evens Venturi Pressures

In a new design by Performance Products Inc. (PPI), Coolidge, AZ, an adjustable bypass valve directs only a portion of mainstream flow around a venturi injector. This secondary fluid loop helps control the pressure differential on both sides of a venturi, and helps to maintain constant chemical-injection rates.

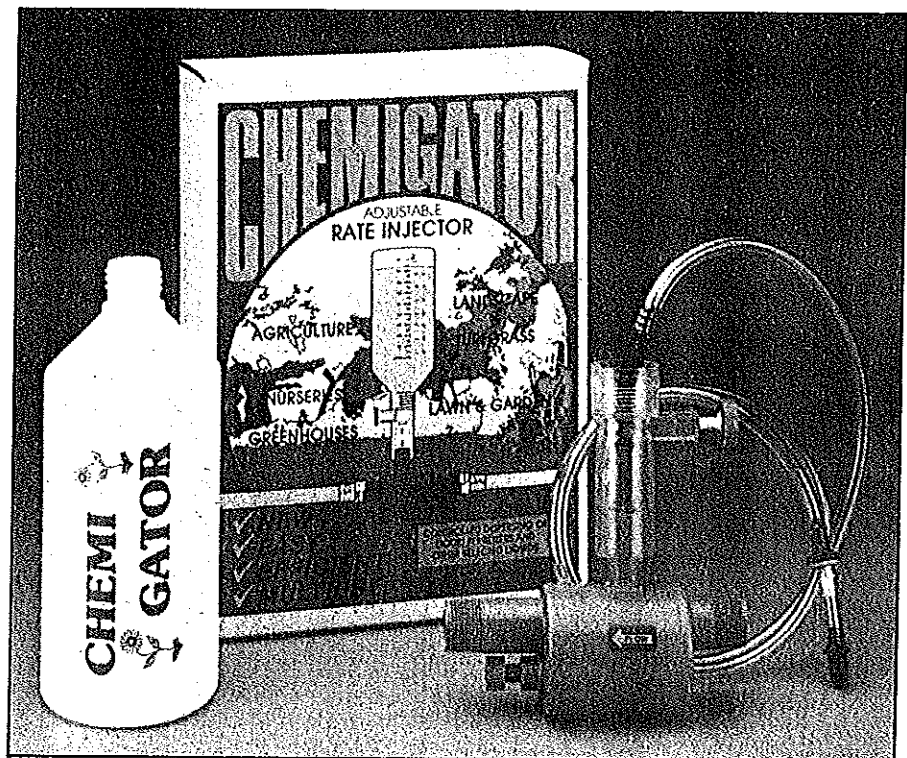

Bale-Loading Winch Boosts Pickup Versatility

An electric winch mounted on the bed of a pickup truck is the key element of a compact system for loading heavy roll-up bales. Powered by a high-torque dc motor, the winch can be teamed with a pivoting right-angle lever arm to "pay out" cable reports Dutton-Lainson Co., Hastings, NE.

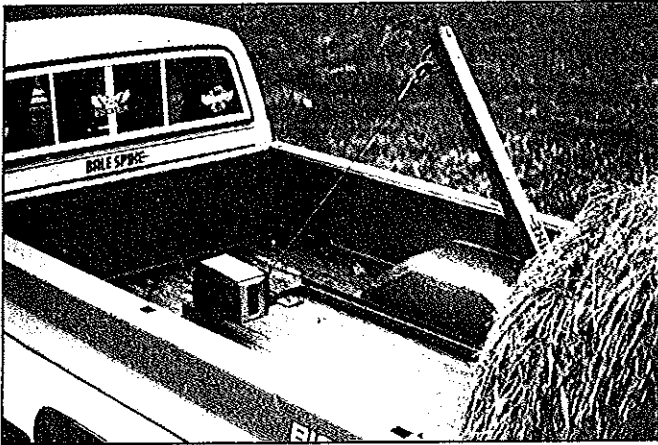

PERMANENT PUMP STATIONS

Why do we have pump stations still in service after 30 or more years on the job? We build them to last. Low to medium head pump stations are our specialty. — RIVER INTAKE — — FLOOD IRRIGATION — — SEWAGE EFFLUENT — — FISH OR SHRIMP FARMING — WATER MANAGEMENT — STORM WATER — Stations 1000 to 1,000,000 GPM and up. We have the equipment — call us. REGISTERED PROFESSIONAL ENGINEERS ON STAFF TO ASSIST IN YOUR EQUIPMENT SELECTIONS.



(305) 426-1500

M&W PUMP CORP.
33 N.W. 2nd STREET
DEERFIELD BEACH,
FLORIDA 33441
TELEX 51-9272

The New Easy Way To Apply Fertilizers, Pesticides, Herbicides

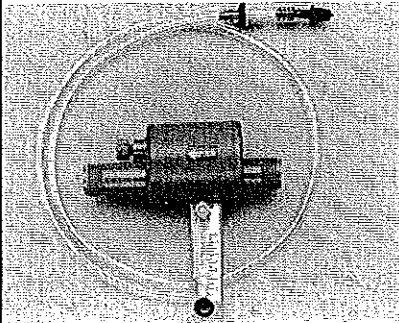

CHEMIGATOR Fertilizer & Pesticide Applicator

A highly efficient injector, with simplicity of control, to achieve and maintain an accurate mixture ratio. The CHEMIGATOR is the multi-use applicator for automatic inline application of liquid fertilizers, pesticides, insecticides, herbicides, detergents and much more!

Use the CHEMIGATOR for:

- Agriculture
- Nurseries, Greenhouses
- Lawns
- Industrial Use
- Home & Garden
- Sprinkler Systems
- Drip Irrigation
- Water Treatment

Performance Products, Inc.

541 West Coolidge Avenue
Coolidge, AZ 85228
(602) 723-5294

Joystick / Cable Rig Actuates Valves

Conventional push-pull cables are teamed with joystick control levers for actuating remote valves and pumps in hydraulic systems aboard tractors, loaders, mowers, and powered implements. Each actuator gives symmetrical action, fits standard 2-in. push-pull cables, moves up to 150-lb loads, and accommodates a ball knob or anatomic grip. Grip options include a SPDT push-button switch and a DPDT rocker switch, reports Quadrastat Corp., Industry, CA.

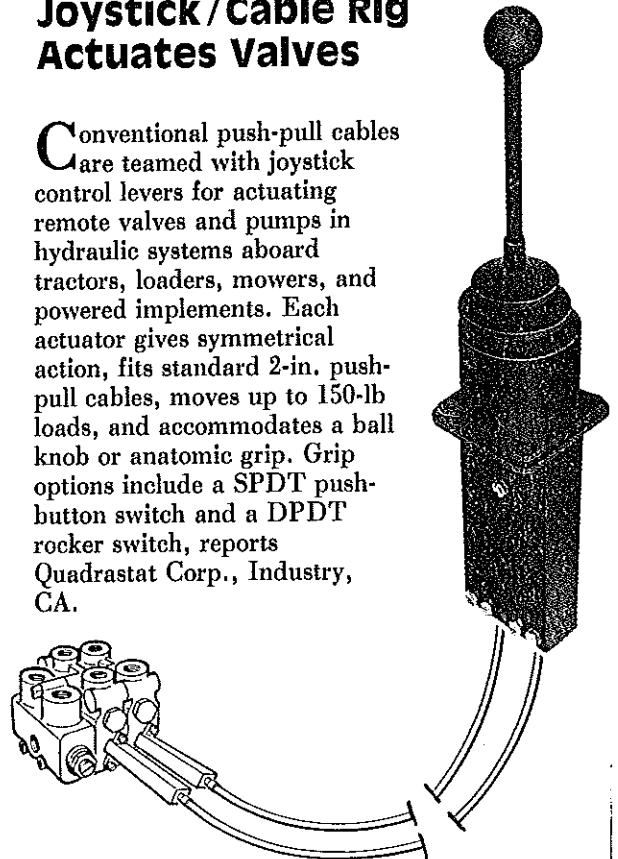

Small Robotic Workcell Mimics Big Factory Units

Availability of an integrated robotic workcell supplants the traditional piecemeal approach used by R&D experimenters, educators, and trainers in assembling needed components for simulation studies, courses in programming, and factory-type learning situations. Combined in one table-top system are a pick-and-place robot arm, rotary carousel, linear slide base, control unit (keyboard, processor, and CRT), software packages, teach pendant, photoelectric sensors, and several supporting accessories. Overall system is also ideally suited for evaluating both basic and advanced workcell designs, reports Rhino Robots Inc., Champaign, IL.

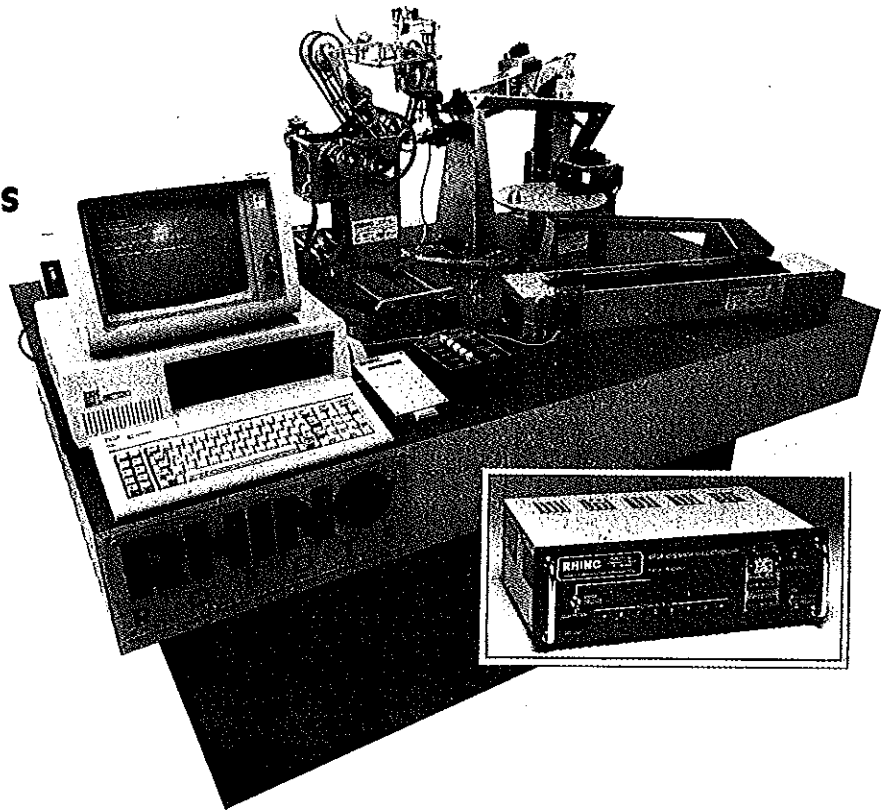

Two Innovative Systems Boost Picker's Productivity

Two patented systems made Case IH's model 1822 cotton picker a significant contribution to the advancement of engineering in agriculture. An innovative pneumatic conveying system keeps pace with the increased throughputs built into modern picking drums. Overall machine efficiency is also improved with a unique basket unloading system that replaces conventional dump baskets and unacceptably high transfer times. The induced air flow conveyor features a nozzle-like device that injects high velocity air into the lower part of a picker drum. This arrangement enables the air jet to draw in large quantities of additional air plus develop enough force to quickly strip cotton from the dollers, whisk it along ducts, and deliver it in a steady stream to all corners of a basket. The new 725 ft² square basket, which is based on proven fork-lift concepts, has two vertical guideways at both the front and rear of the machine. Rollers engage the guideways as four hydraulic motor-driven plunger chains impart a powered (and metered) unloading of up to 4,400 lb. of cotton from the side-pivoting basket. A basket load's center of gravity always stays within a picker's main frame envelope, reports Case IH, Racine, WI.

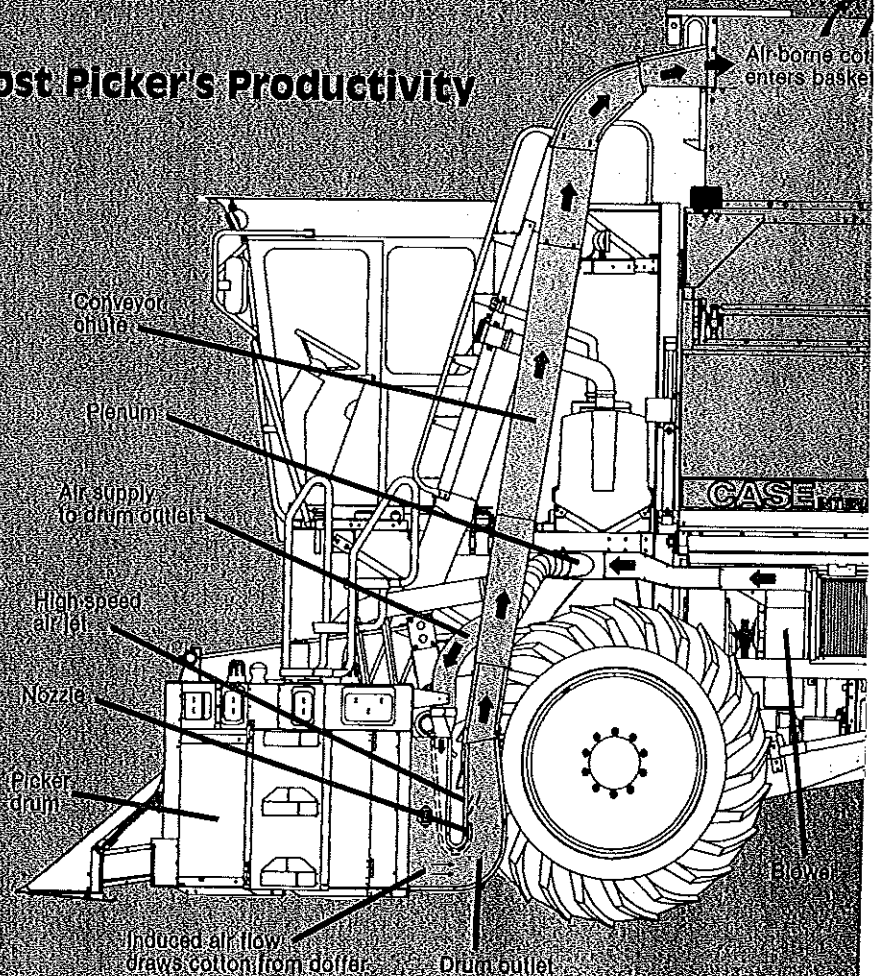

High-Tech Imagery Boosts Earthly Capabilities

Satellite-based imaging moves into an advanced era with the 1986 orbiting of Spot 1. It is claimed to give the civilian/commercial sector's first access to ultrahigh resolution 10-m panchromatic and 20-m multispectral data in both digital and photographic formats. The Spot program is spearheaded by a French agency in cooperation with Sweden and Belgium. Agricultural-type images — for soil surveys, crop monitoring, pest assessment and control, yield estimates, surface water, drainage patterns, and density of forest stands — are available to U.S. subscribers from Spot Image Corp., Reston, VA.

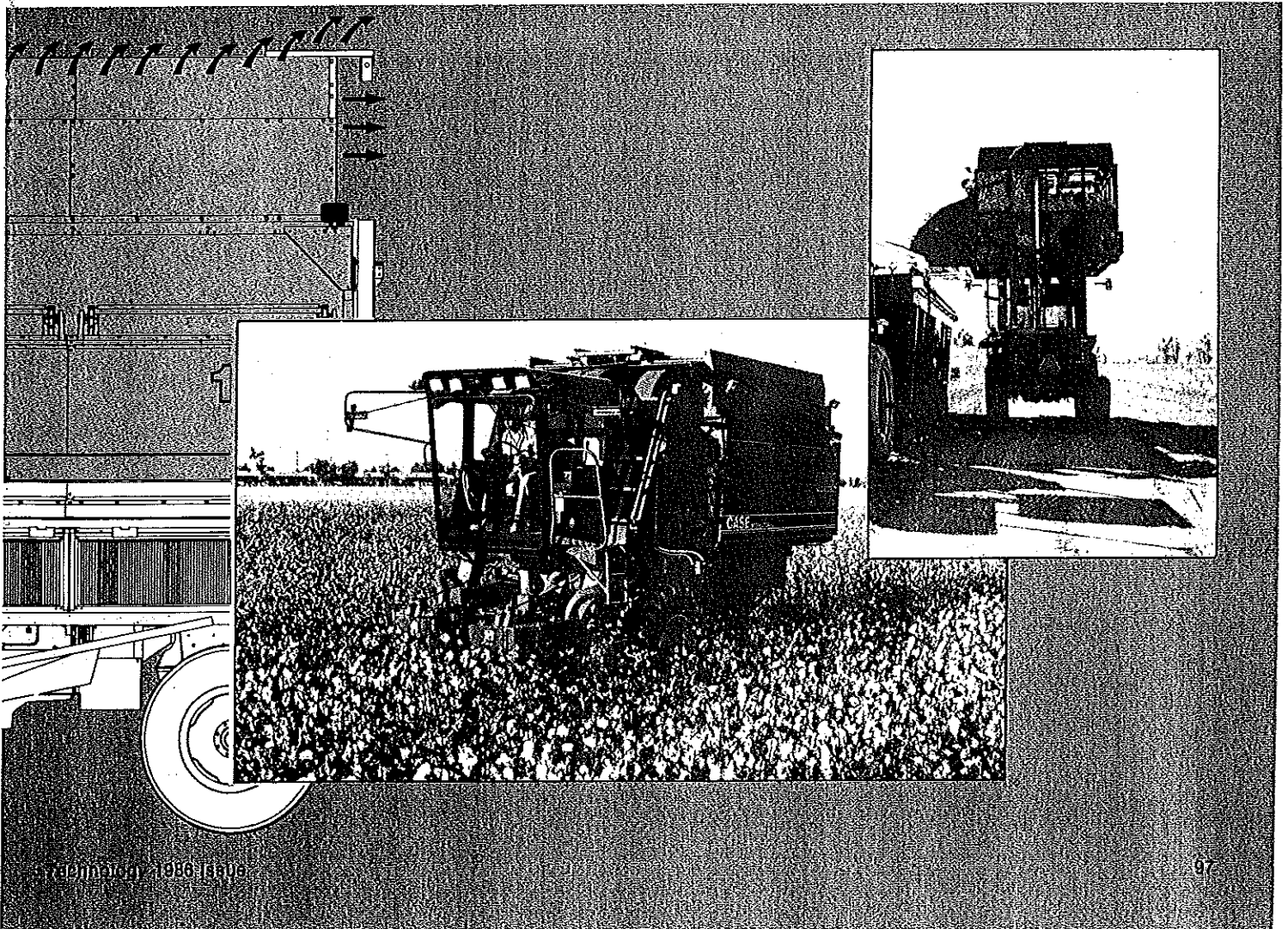
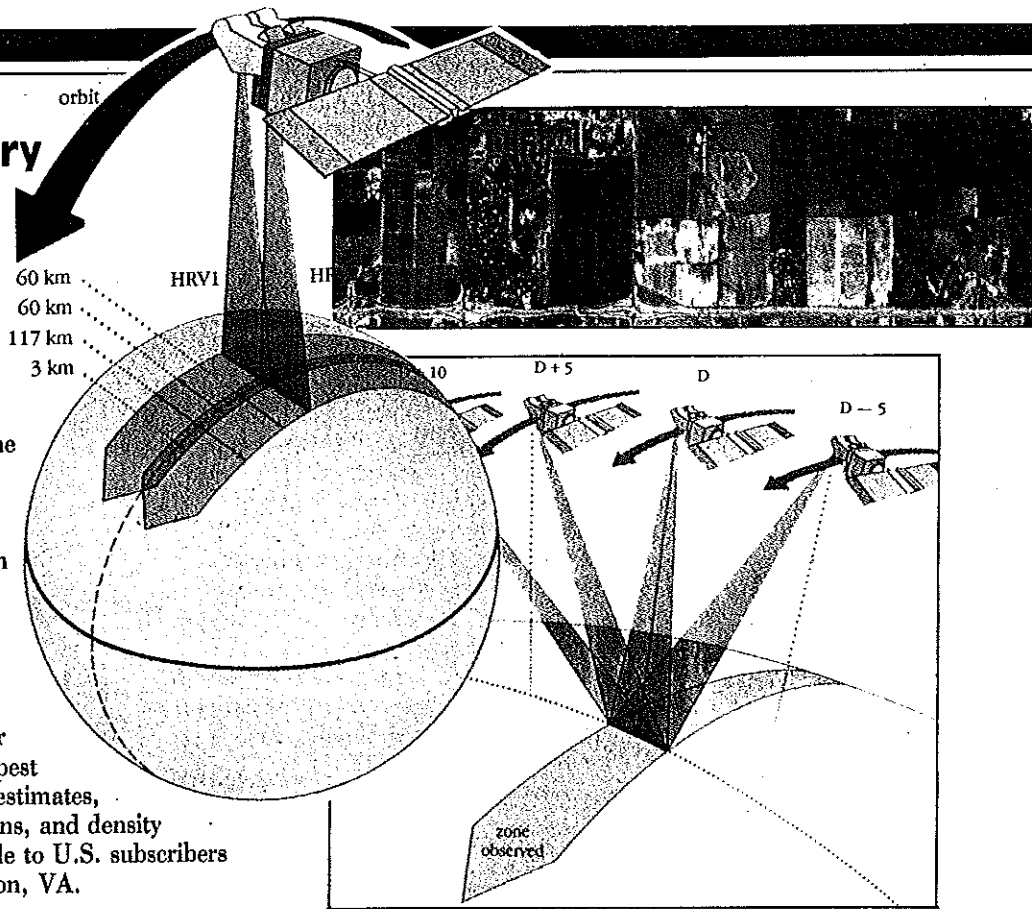

Pig-Tending Heaters Curb Farrowing Losses

Ceramic bar infrared emitter is mounted in a parabolic reflector to give uniform temperatures throughout the rectangular heating zone in farrowing creeps. The design replaces conventional heat lamps that overheat a large space within an area reserved for young pigs. New closed-loop system features an electronic sensor, which is suspended within the field of radiant energy, and a microprocessor-based control system. This arrangement ensures accurate temperature control in the creep zone while preserving a cooler adjacent environment for lactating sows. Heating systems for multiple creeps are connected to a master control that keeps tabs on remote sites, gives readouts of creep temperatures (within 0.1 °F), and shows energy consumption rates. Control system can also change temperature levels as pigs grow from birth to several weeks of age. Accordingly, the heated creep zone can be maintained at preselected levels from 96° down to 72 °F, reports SBM Heating Inc., Fredericksburg, VA.

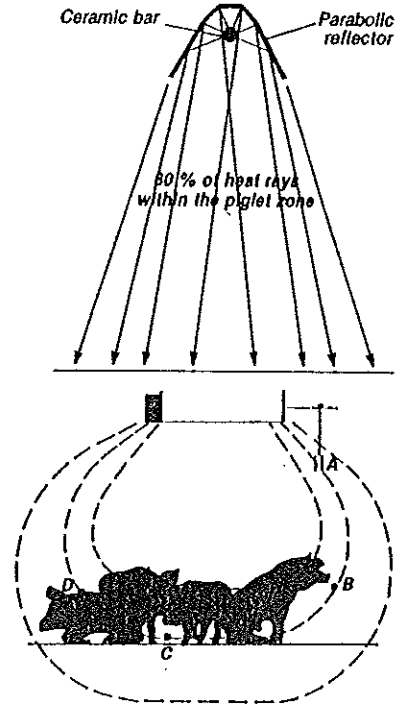

Solid-State Monitor Gives Acreage Updates

Electronic monitor computes and displays a choice of field performance data including travel speed (mph), accumulated acreage and total acreage. Data are presented on a nondedicated, five-digit, vacuum fluorescent display. The programmable solid-state control unit is rated for a

0.1A maximum current draw with an input voltage of 10 to 15 Vdc. Developed by the Controls Div. of Eaton Corp., Carol Stream, IL, the acreage-tracking device is expected to find use with planters, sprayers, combines, tractors, and trucks.

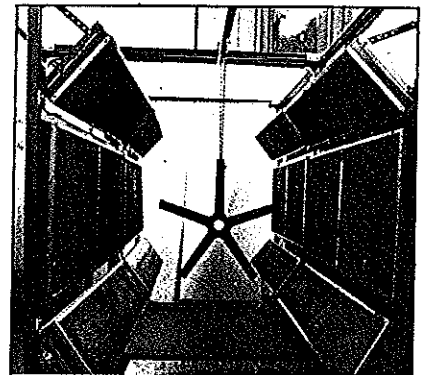
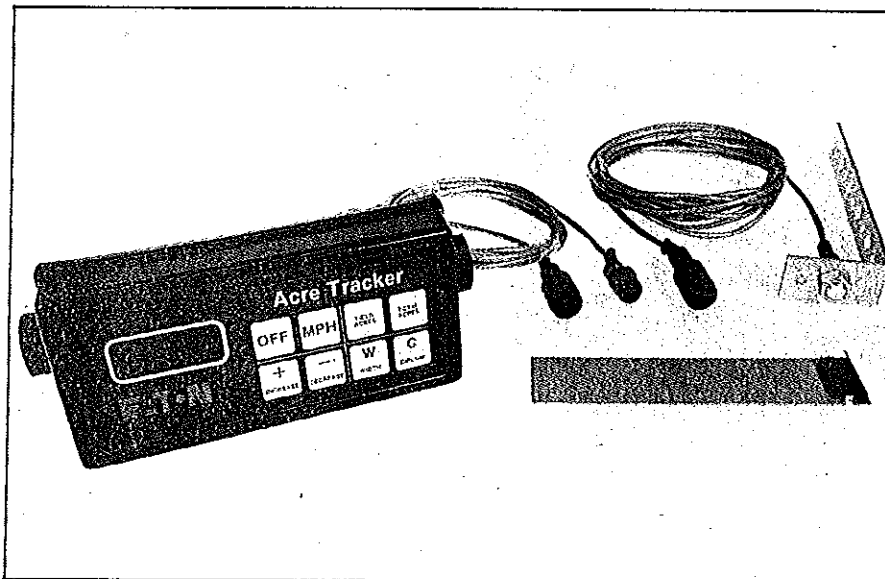

Catalytic Industrial Systems, Inc. is the Industrial Sales Division for the Bruest Industrial Group.

Bruest has over twenty years experience as a manufacturer of engineered process ovens and space heating systems.

The heart of the system is the utilization of the Bruest Gas Catalytic Infra-Red heater, which has proven to be a highly efficient, economical and maintenance free design.

For information or the name of the nearest rep contact Catalytic Industrial Systems, Inc. (316) 331-0750 or (800) 835-0557.

Catalytic Industrial Systems, Inc.
20th and Sycamore
POB 827
Independence, Kansas 67301

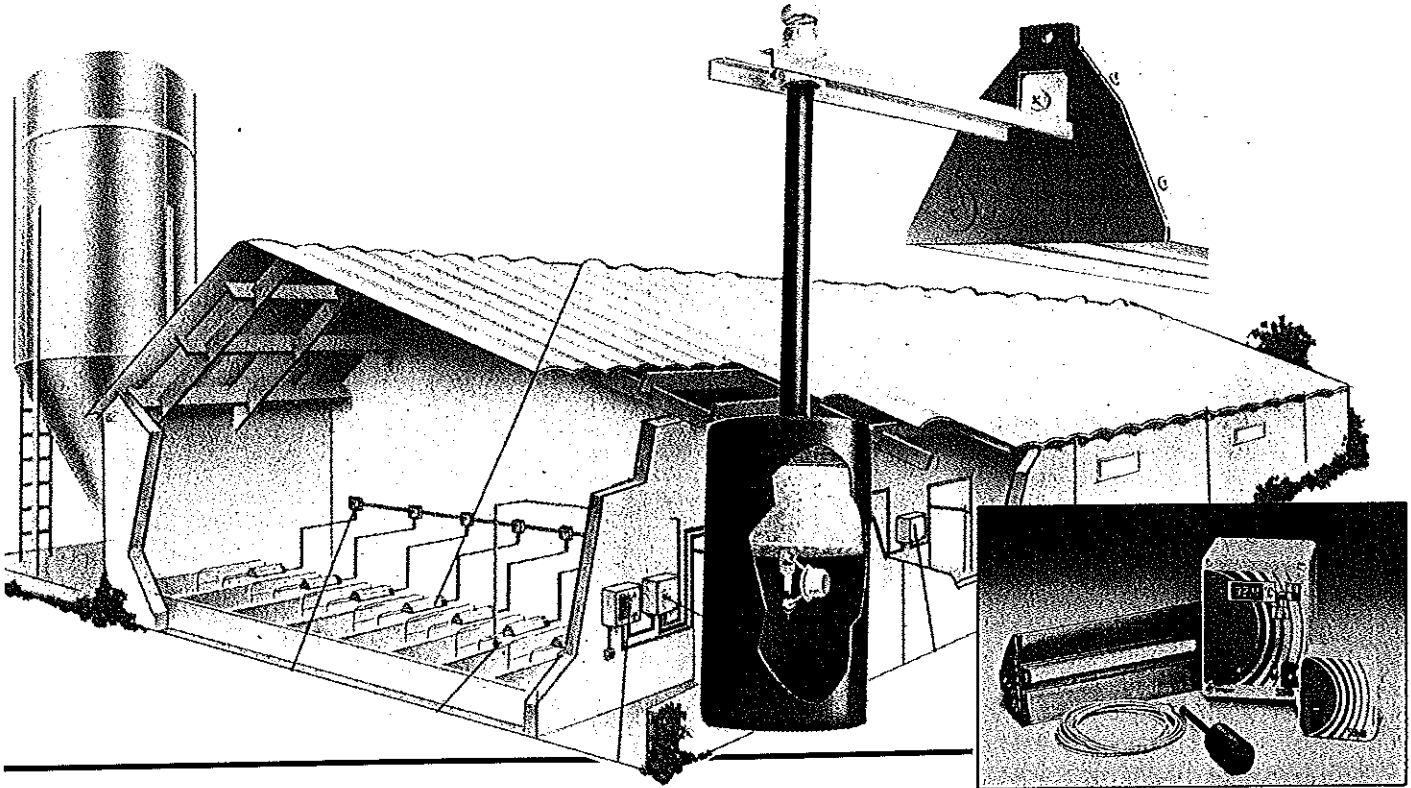

Flow-Blocking Butterfly Feeds Gated Piping

Cam-actuated butterfly valve swings open to release water into 6, 8, or 10-in. diam gated pipe for furrow-type irrigation. The rubber-coated steel butterfly is driven through a gear reducer by a small dc motor. Controlled through a battery-operated timer, the horizontal valve can be programmed for

sets ranging from 1 min to 7 days, reports Ed Oest, president, Irrigation Systems Co. of Western Colorado, Fruita, CO. In addition, a pivoting lever attached to the valve gives operators a remote visual indication of the unit's open or closed status.

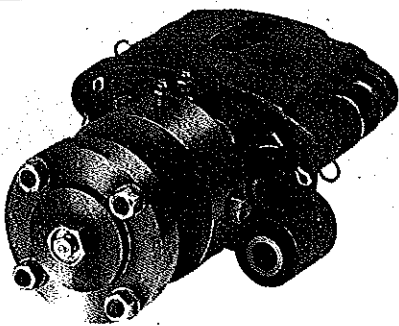

Hayes Brake's 663-SB is a combination hydraulic service and spring apply/hydraulic release secondary/park brake. The 663-SB is new in Hayes' line of disc brakes for the agricultural industry.

Designed for in wheel, the 663-SB develops 68,000 in. pounds service brake torque and 31,000 in. pounds of park/secondary torque with a 20" diameter rotor.

Features include: self adjusting, sealed pin mound, and hydraulic or brake fluid seals.

HAYES INDUSTRIAL BRAKE INC.
5800 W. DONGES BAY RD.
MEQUON, WISCONSIN 53092
414-242-4300

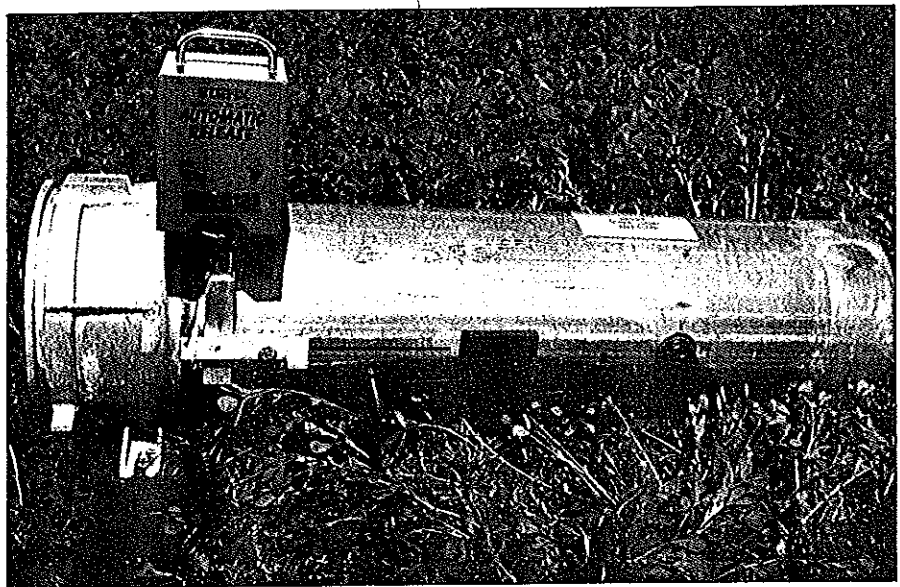

High-Resolution Plotter Draws 'Stepless' Lines

Software-driven plotter of C and D-size engineering drawings has a resolution of 0.0254 mm (0.001 in.), which is now compatible with the HPGL control language. This hardware/software combination controls plotter acceleration and velocity along both X and Y axes to maintain constant speed, uniform ink flow, and proper line width. Controlling plot motor velocities throughout an arc or circle produces smooth contours, thereby making imperceptible any hint of steps in angled or curved lines. In contrast, most conventional plotters operate along a series of short vectors in a polygonal approximation to an arc or circle. A built-in diagnostic monitor includes status-indicating LEDs, self-test mode, and a simplified computer

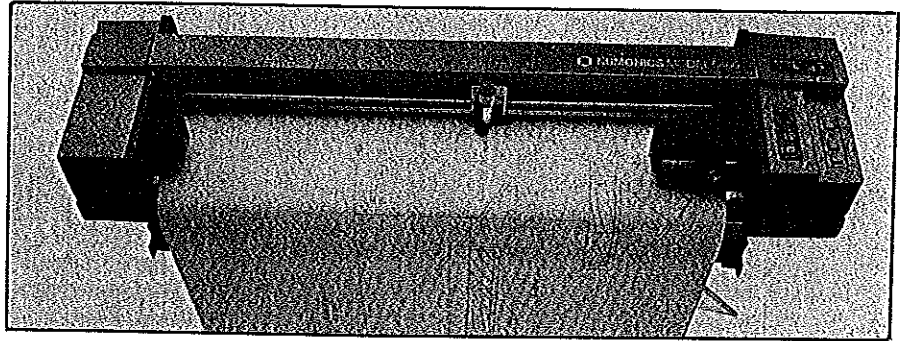

interface. According to Numonics Corp., Landsdale, PA, the low-cost plotter works at speeds up to 7.7 ips, gives an accuracy of 0.5%, and maintains a repeatability of 0.008 in. Plotter can accept fibertip, ballpoint, ceramic, or liquid-ink pens and work on vellum, bond papers, and up to

0.0035-in. mylar. Wide range of applications includes drawing output from computer-aided design and interactive graphics routines.

Plastic Tank Teams With Full-Swivel Valve

Control valve built into knapsack-type sprayer swivels through 360 deg, allowing an operator to turn the curved 18-in. extension and aim a brass-cone nozzle for accurate delivery. Output can be adjusted from a foliage-penetrating fine mist to a stream capable of reaching trees up to 15 ft high. A lever-action brass pump develops pressures up to 100 psi for the sprayer, which has a Buna-N elastomer plunger cup and a 4.5-gal polyethylene tank. Sprayer's 54-in. long hose is rated for working and burst pressures of 250 and 1,000 psi, respectively. All material choices resist corrosion in handling insecticides, herbicides, fungicides, and liquid fertilizer, reports H.D. Hudson Mfg. Co., Chicago, IL.

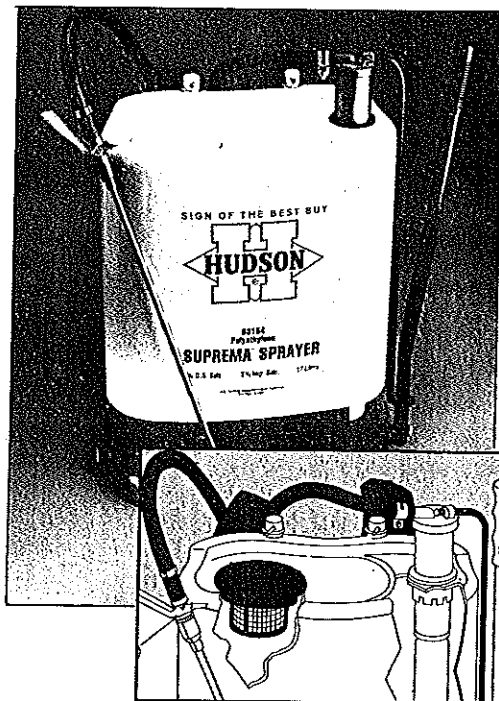

Introducing the PRO JR. controller

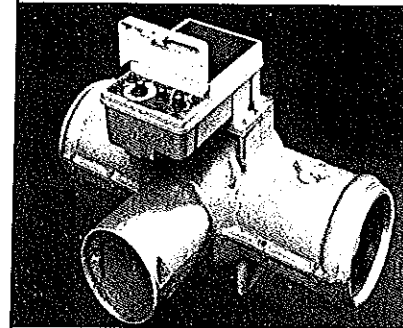

- solar powered
- automatic
- easy to operate
- at an unbelievable low price

Improve water distribution, cut irrigation time, reduce tailwater with a SURGE IRRIGATION valve

A semi-automated water management tool for furrow irrigators. Surge can lower water, energy fertilizer and labor costs, raise your irrigation efficiency, and deliver savings of 20 to 40 percent or more.

For a free brochure and prices contact: P&R Surge Systems, Inc.
P.O. Box 3361
Lubbock, TX 79452
(806) 747-0065

Pressure-Boosting Pump Forces Water Uphill

Pressure-intensifier principle is harnessed in a double-acting piston pump for drip and sprinkler irrigation systems, livestock water supplies, and gravity-based aquaculture schemes. In the patented pump design, a relatively large volume of fluid at low pressure is converted into a smaller fluid volume rated for a much higher pressure (insert drawing). This capability enables the pump to lift water up to 2,000 ft and deliver up to 50,000 gal/day. Inlet specifications call for a 2-in. pipe, minimum flow of 2 psi, maximum pressure of 100 psi, and a maximum flow of 100 gpm. Pumps can be built with volumetric ratios from 2:1 through 22:1, reports High Lifter Water Systems, Willits, CA. Maximum corresponding delivery rates for these ratios are from 5,000 to 50,000 gpm. The water-powered pump can thus harness energy from a head of water and drive a portion of this water to a higher elevation (sketch), claim the developers.

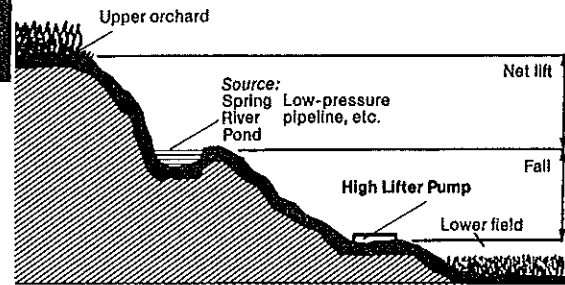
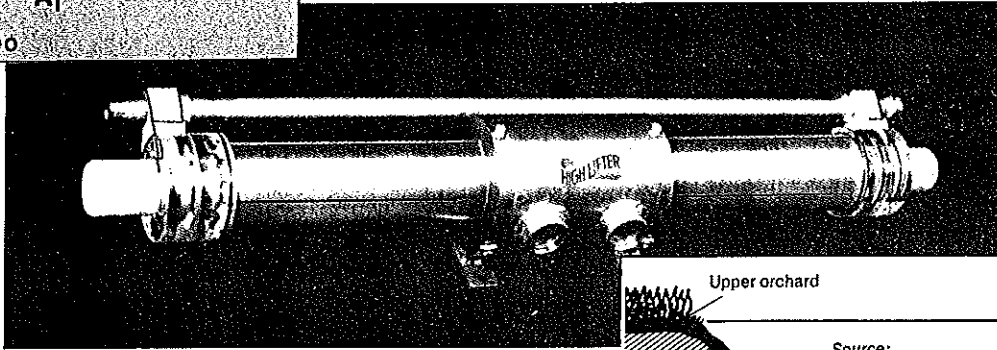
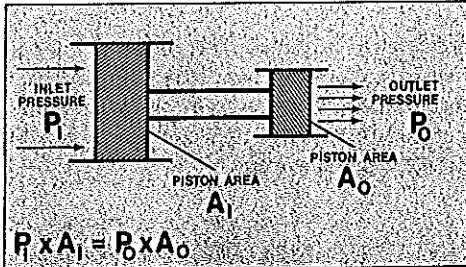

HYDRAULIC MANIFOLD, CONTROL, AND RESERVOIR SYSTEM

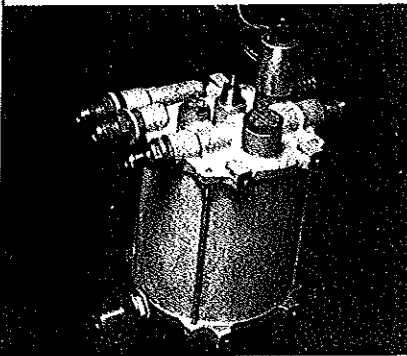

- Compact and lightweight
- 12 Volt on-off control
- Adjustable output flow control
- Selected relief valve spring
- Pressures to 2500 PSI
- Built-in filter screen
- Optional heat exchanger and filter parts

Supply only the input hydraulic pump and output motor combination to meet most hydraulic powering needs.

Agrinautics' hydraulic control and reservoir system simplifies your plumbing system down to **ONLY** two pump lines and **ONLY** two motor lines.

WHAT IS MORE COMPACT AND AFFORDABLE?



1333 E. Patrick Lane
Las Vegas, Nevada 89119

Phone (702) 736-3794 Cable: AGRINAUT

Auger Insert Cleans Grain in Two Stages

Two-part mechanism adapts a conventional auger conveyor for cleaning grain. Primary cleaning action is produced by a bottom-mounted vibrating screen. An enclosed motor imparts 3,200 oscillations/min of shaking action while rubber sleeves isolate the vibration from other conveyor parts. Secondary cleaning results as a top-mounted 530-cfm blower pulls air through the traveling grain to remove chaff, insects, and other lightweight debris. The auger insert device is secured with two flanking tubular frames and a stabilizer rod. Two-stage grain cleaner is built by Custom Products of Litchfield Inc., Litchfield, MN.

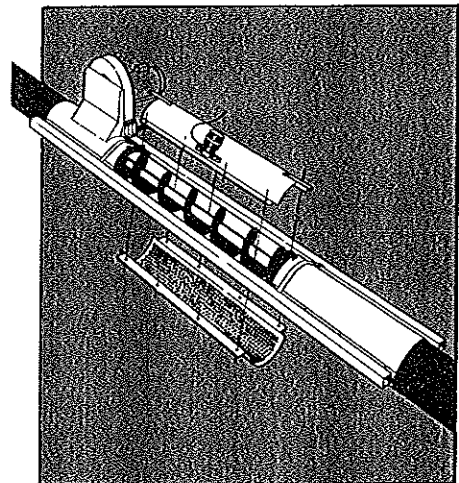

'Smart' Sensors Permit Design of Self-Steering Baler

A built-in steering system enables a towed hay baler's 60-in.-wide pick-up to weave from side-to-side across a windrow as the tractor operator maintains a straight-ahead driving path. Baler steering is effected through hydraulic cylinders connected to each of the baler's half axles (diagram). However, the system's major design breakthrough is a proprietary sensor array

located in the bale chamber, reports Vincent Newendorp of Vermeer Mfg., Pella, IA. Sensor data go to a tractor-mounted monitor for signal processing, then are routed to an electrohydraulic system.

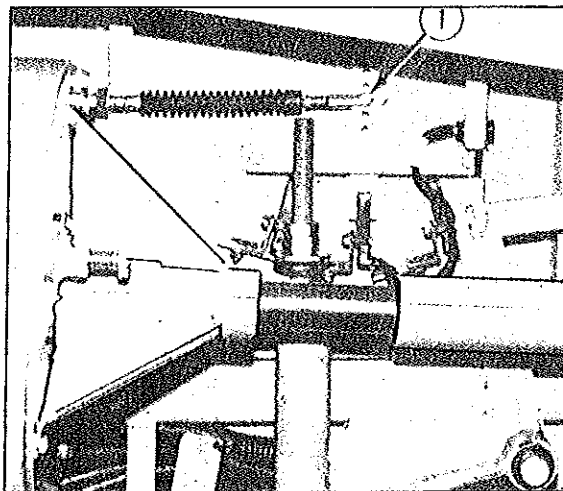
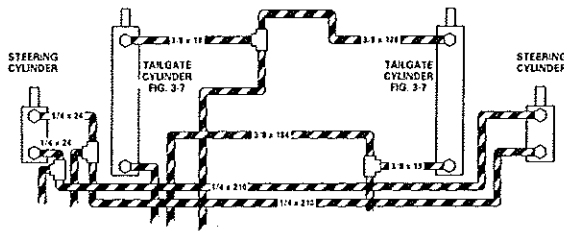
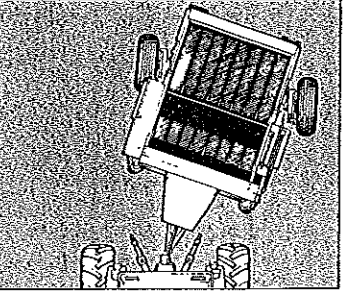
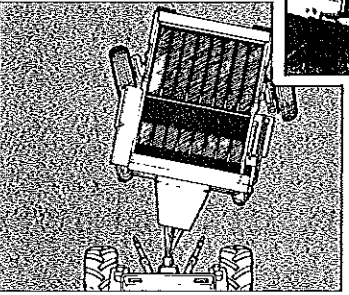
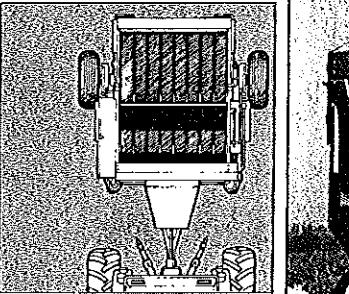
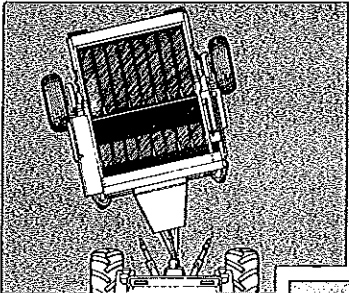
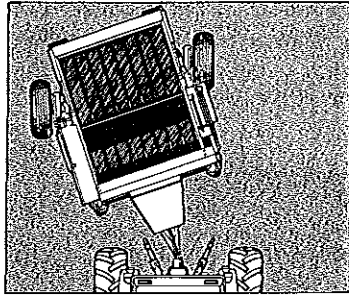

SAVE up to 50% on energy costs!

SUPERB ENERGY MISER

CONTINUOUS FLOW ALL-CROP DRYERS

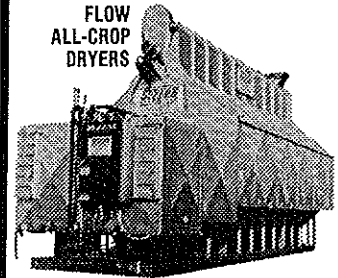

- Recycles heat from cooling and drying.
- Easy to exhaust all air if desired.
- Drying Optimizer™ controls cooling and drying air proportions.
- Can use low drying temperatures for heat-sensitive crops.
- Exclusive cleanout system!
- Walk-In Internal access.
- Factory preassembled.
- No crane required.
- Very quiet, efficient drying.
- Easy internal access.
- Internal vaporizer included.
- Nine models available (250 to 1000 BPH).
- Options:
 - Automatic Moisture Control
 - PTO drive
 - Dryeration, combination drying, rice drying

SUPER 3 STAGE CONTROLLED AUTOMATICS

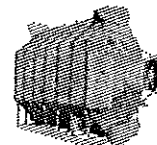

Sweat® Drying

Set the dial. Flip the switch. Forget it.

BEARD INDUSTRIES
Frankfort, IN 46041
Phone 317-654-8517

Bin-Straddling Truck Speeds Fruit Handling

High-clearance orchard fork truck lifts and stacks 4 by 4-ft bulk bins within its framework, then transports and deposits the bins one at a time or in multibin stacks. Truck can also straddle a row of bins and pick up only those that are full (or empty). Built with an 82-in. wheelbase and an 81-in. track, the 4-wheel drive straddle fork is powered by a 4-cylinder gasoline or

diesel engine. Engine drives a positive displacement, variable volume pump that teams with piston-type wheel motors, each rated for 2,000 lb-ft or torque. The rear-wheel steer vehicle has top speeds of 6 and 12 mph with four-wheel and two-wheel drive, respectively. Able to negotiate rough terrain with heavy loads, the straddle fork facilitates a linear bin-handling

system that reduces soil compaction, conserves irrigation furrows, and is gentle around trees. Conventional fork lift methods entail a zig-zag travel pattern that often damages trees, irrigation systems, and drainage furrows, reports Andrew Kornylak, R&D manager, Agricultural Systems Div. of Kornylak Corp., Hamilton, OH.

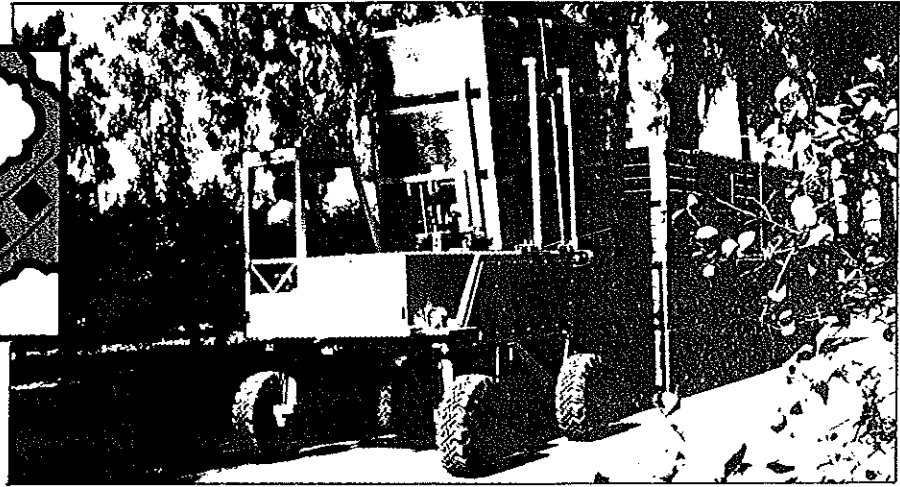
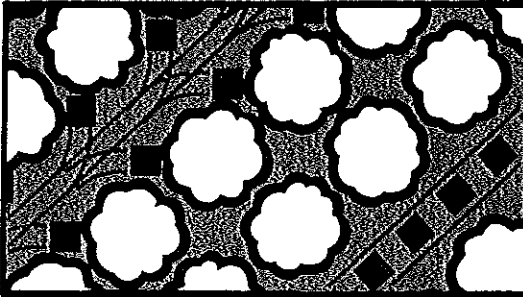

Eliminate Costly Oil Pressure Switch Installations for actuating Solid State hour meters and Tach/Hour meters.

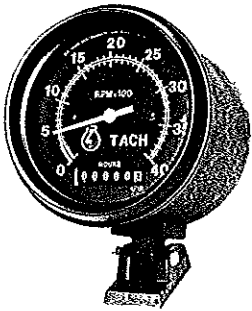

Model 28 Tach/Hour Meter with Inhibitor Circuit. Shown in optional Mounting Kit, Part No. 71461-00.

Tach/Hour Meter has built-in circuitry which prevents the Hour Meter portion from accumulating time below idling threshold. Suitable for 12V DC or 24V DC operation.

DATCON INSTRUMENT COMPANY
East Petersburg, PA 17520 • Phone (717) 569-5713

Prop-Nozzle Combo Boosts Spray Penetration

Variable-pitch propeller is located over a conventional spray nozzle and protected by an open-mesh cage. Driven by a hydraulic gearmotor, the prop entrains spray patterns in high-velocity air flows able to penetrate dense plant canopies. The technique is said to improve control of pesticide applications and result in greater deposition of foliar nutrients. This occurs as turbulence in a canopy's micro-climate flips the leaves, enabling deposition on lower surfaces to approach that on upper leaf surfaces. In addition, any large droplets in a spray pattern are "smeared" into small droplets for more extensive coverage. An air-misting prop can be adapted to most sprayer booms, says Sprayrite Mfg. Co., West Helena, AR.

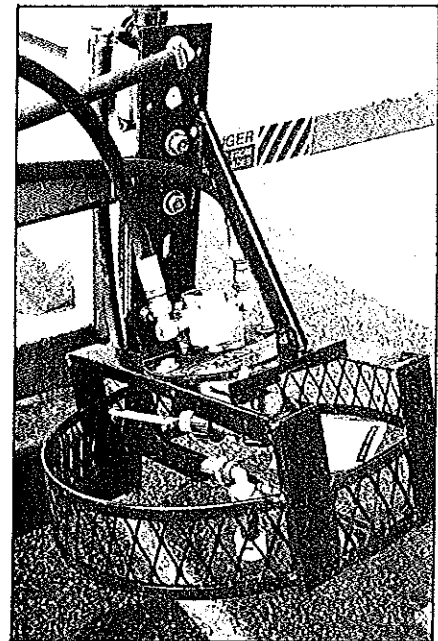

CAD Finetunes Seed Separating Devices

Use of computer-aided design (CAD) has led to several major improvements in a multideck, gravity-type separator for seeds. One area of improvement is the multiple-fan air supply, which is more efficient and quieter than in previous models. A fiberglass suspension system has eliminated the conventional clamps and screw-type adjustments. All adjustments are now made hydraulically through a seven-lever control console. An aluminum deck frame is teamed with a cantilever deck

to give a stronger, lighter deck while reducing its overall weight, reports James Thomas, chief engineer for Oliver Mfg. Co., Rocky Ford, CO. Along with these materials improvements is a new counterbalance system that enhances separation while minimizing extraneous vibration. Altogether, these features combine to give capacities up to 30,000 lb/h for crops such as edible beans. Three new models of Oliver separators have deck areas of 40, 60, and 90 ft².

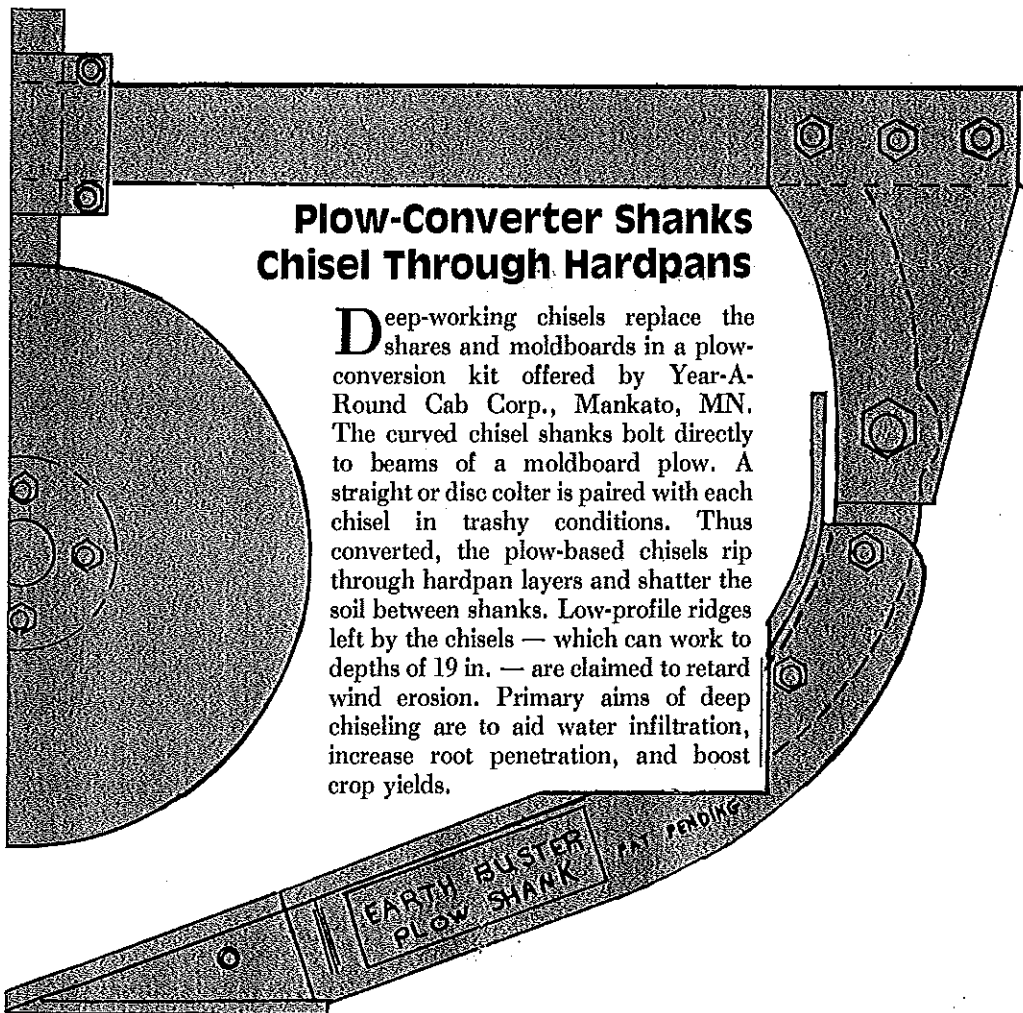
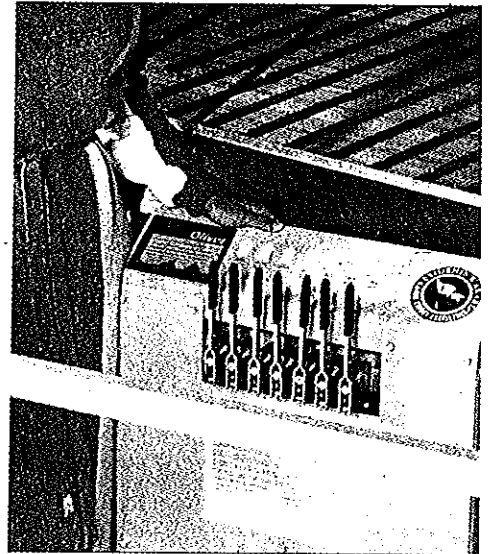

Plow-Converter Shanks chisel Through Hardpans

Deep-working chisels replace the shares and moldboards in a plow-conversion kit offered by Year-A-Round Cab Corp., Mankato, MN. The curved chisel shanks bolt directly to beams of a moldboard plow. A straight or disc colter is paired with each chisel in trashy conditions. Thus converted, the plow-based chisels rip through hardpan layers and shatter the soil between shanks. Low-profile ridges left by the chisels — which can work to depths of 19 in. — are claimed to retard wind erosion. Primary aims of deep chiseling are to aid water infiltration, increase root penetration, and boost crop yields.

WHY PAY INFLATED PRICES FOR YOUR SOIL SAMPLERS?

Equip Yourself with Quality
EIJKELKAMP Soil Samplers & SAVE!

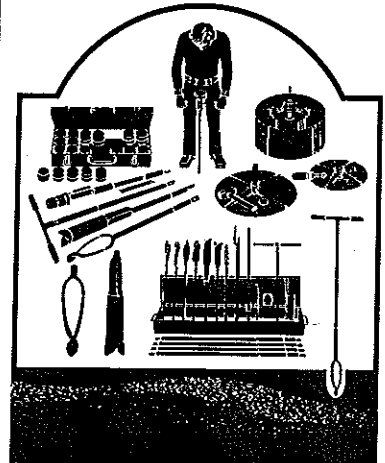

Ask today for our catalog of Soil Testing Equipment with the Best Quality at the Lowest Prices in America!

SAUZE TECHNICAL PRODUCTS CORP.

345 Cornella, Plattsburgh, NY 12901 (518) 561-6440

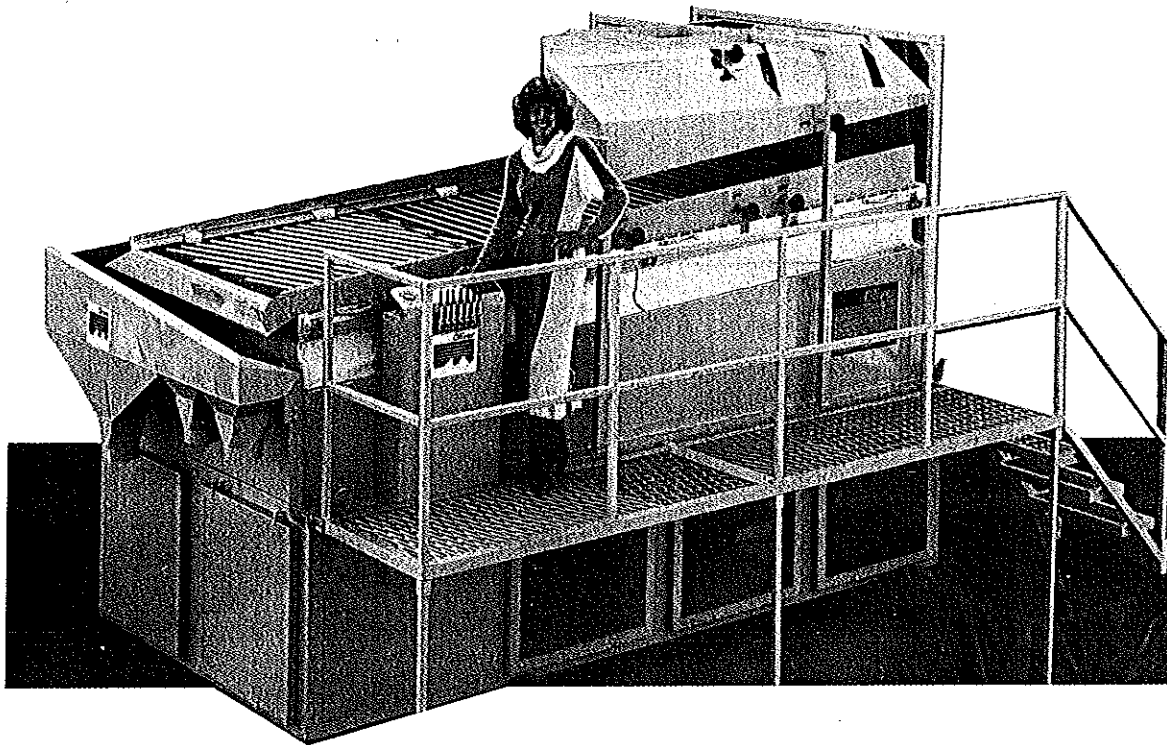

DIAMOND PLASTICS

PVC Irrigation Pipe Specifications

NORM. SIZE (IN.)	TYPE	AVG. O.D. (IN.)	MINIMUM WALL THICKNESS				
			50 PSI	80 PSI	100 PSI	125 PSI	160 PSI
PIP SIZES							
4	PIP	4.130			.100	.127	
6	PIP	6.140	.076	.120	.150	.169	
8	PIP	8.160	.101	.160	.199	.251	
10	PIP	10.200	.126	.200	.249	.314	
12	PIP	12.240	.151	.240	.299	.377	
15	PIP	15.300	.189	.300	.373	.471	
18	PIP	18.701		.367	.456	.576	
21	PIP	22.047		.432	.538	.678	
24	PIP	24.803		.486	.605	.763	
27	PIP	27.953		.548	.682	.860	
IPS SIZES							
1	IPS	1.315			.050	.063	
1 1/4	IPS	1.650			.064	.079	
1 1/2	IPS	1.900			.073	.090	
2	IPS	2.375			.091	.113	
2 1/2	IPS	2.875			.110	.137	
3	IPS	3.500			.135	.167	
4	IPS	4.500	.110	.138	.173	.214	
6	IPS	6.625	.162	.204	.255	.316	
8	IPS	8.625	.210	.265	.332	.410	
10	IPS	10.750	.262	.331	.413	.511	
12	IPS	12.750	.311	.392	.490	.606	

Manufacturing Plants
1212 Johnstown Road
Grand Island, Nebraska 68802
(308) 354-4200

2323 Marshall Street
Lubbock, Texas 79406
(806) 783-8021
©1983 Diamond Plastics Corporation

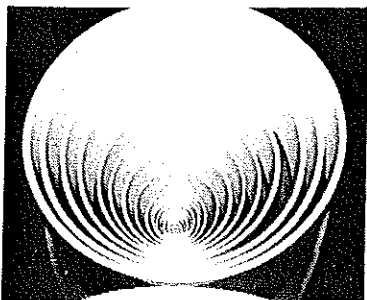

Out-of-Phase Rotors Vary Port Geometry

Two sets of vane-like rotors give eight pumping cycles per revolution of the input shaft in a new type of rotary pump. Patented by Flotech Inc., Denver, CO, the design is said to combine key operating advantages of both centrifugal and positive displacement pumps. Internal arrangement consists of four discrete chambers wherein each completes two pump cycles per shaft revolution. Rotor

vanes form chamber partitions that open and close relative to each other, forming variable-geometry ports that give high flow rates across a broad pressure range. Pump can handle fluids with high viscosities and those with considerable particles. Alternatively, the design can be manifolded to pump several different fluids through the same cylindrical case.

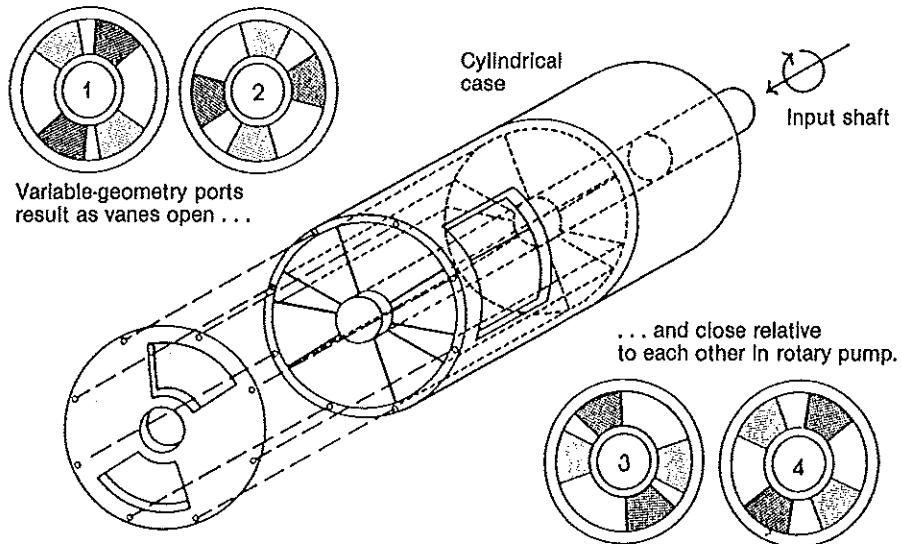

Plastic Membrane Relays Accurate Humidity Cues

Thin-film polymer operates on a capacitance principle to sense relative humidity with a $\pm 2\%$ accuracy over the 0 to 80% range, and with a $\pm 3\%$ accuracy from 80 to 100% humidity. This sensor membrane is teamed with a dc-powered transmitter, which can be obtained for ratings of 4 to 20 mA. Only two wire connections are

needed for duct or wall-mounted versions of the sophisticated electronics package. Overall sensor/transmitter system is claimed to be accurate and reliable in measuring and controlling humidity for retrofitted, upgraded, and new installations. Maker of the instrument is Vaisala, Inc., Woburn, MA

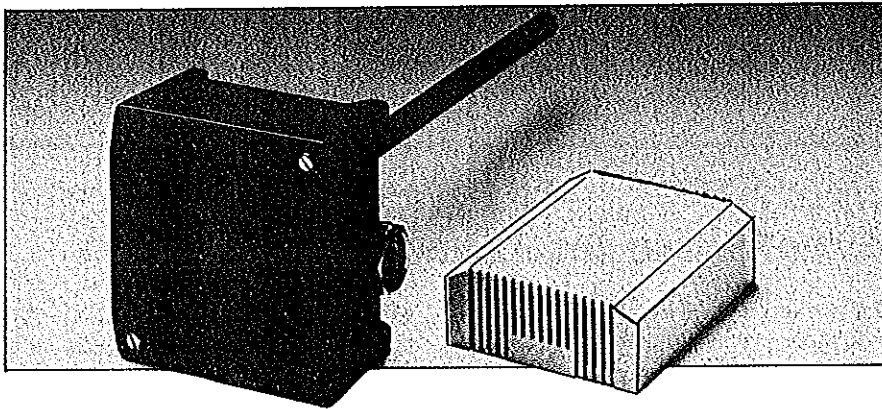

CECO
Engineered Quality

The difference is our unique, patented steel-truss framing system... giving the Ceco building greater structural strength, maximum interior clearance and longer life. Add our concrete pier system, stress-rated wall and roof design, all-steel sliding doors and long-lasting steel paneling.

Then you can select the building components, colors and options to fit your special needs. That's why we're proud to say Ceco is...

The Finest Engineered Rural Building in America

For Immediate Service Call
Toll Free Number - 1/800/323-3469
In Illinois - 1/800/826/2659
Or Write:
241 Frontage Road Unit #39
Burr Ridge, IL 60521

Rural Building Systems
The Ceco Corporation / A Ceco Industries Company

Tractor-Implement 'Smarts' Gain Several New Wrinkles

Several enhanced capabilities are featured in Case IH's tractor-implement communication links. Tractor instrumentation can now monitor more areas, combine several functions, and offer a more intelligent format. For example, a floating set point eliminates warnings of low oil pressure until an engine comes up to speed, yet it still alerts an operator before any damage can occur. In similar fashion, time delays allow for thick transmission fluid to warm up in cold weather.

Tractor-mounted radar guns for sensing true ground speed form another basis for extended capabilities. New generation guns aboard Case IH tractors operate at 20 GHz to give greater sampling rates and faster response times than did earlier models

with frequencies of 10-12 GHz. Radar sensors can now drive implement monitors and traction instrumentation through a bus interface. These hookups are widely used to calculate planting and spraying rates.

Precise monitoring of true acreage is now possible through a lift switch installed on various implements. This device stops indicated acreage that otherwise accumulates on headlands and during transport. In addition, tractor instrumentation teamed with a radar sensor can now calculate and display the percentage of wheel slip, thus alerting an operator to adjust ballast. Systems used by Case IH include radar sensors supplied by TRW's Eagle Controls Div. and tractor instrumentation that is custom designed by Dickey-john Corp.

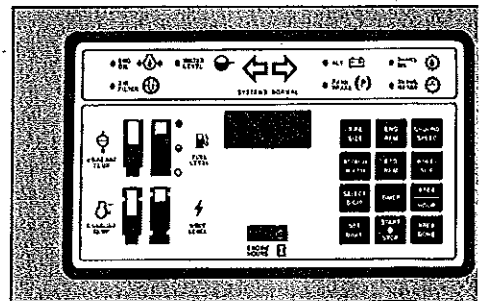
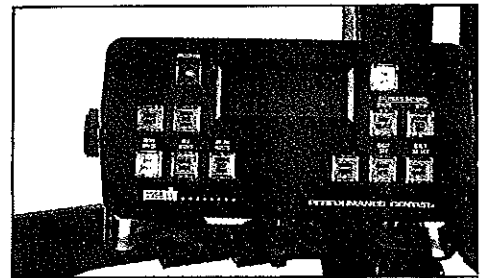

Put-Anywhere Tricklers Give Pinpoint Watering

Self-punching edges allow trickle devices to be installed where needed along irrigation laterals. Following installation, the devices can be adjusted for flow rates of 0 to 10 gph. Built-in flexibility helps tailor a trickle system to tree locations when applying water, fertilizer, or chemicals to an orchard. Pinpoint placement and rate control combine to reduce fertilizer leaching, minimize water runoff, and lower plant stresses. The adjustable trickle devices are built by Tico Industries Inc., Williamstown, NY.

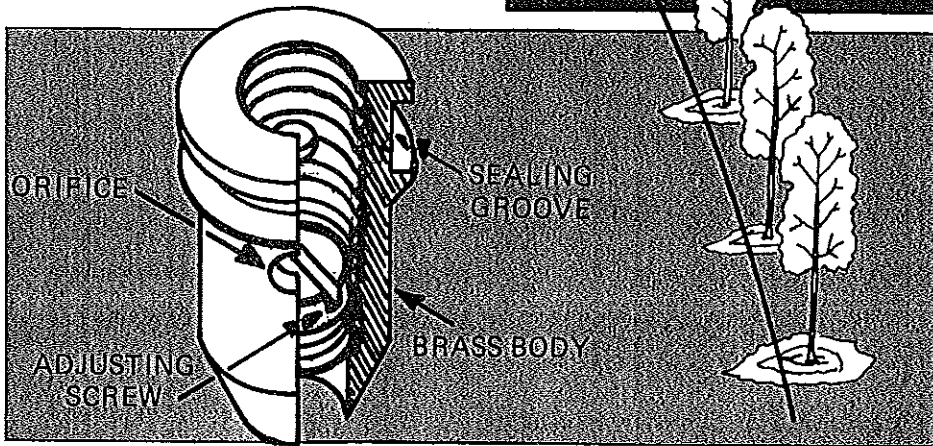
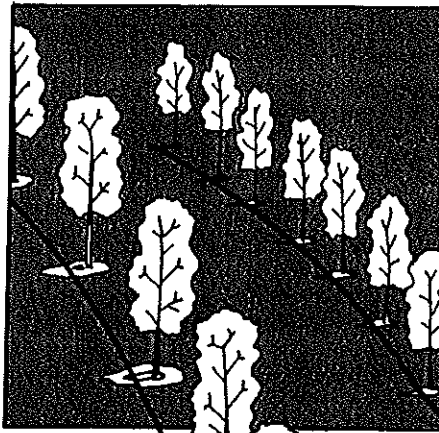

IRROMETER FINEST TENSIOMETER

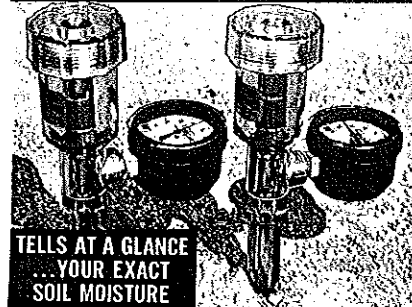

TELLS AT A GLANCE
... YOUR EXACT
SOIL MOISTURE

SAVE WATER with Irrigation Management

The IRROMETER Irrigation Management System is the simplest, most accurate means of determining soil moisture needs. The IRROMETER System normally increases crop production while reducing irrigation costs. Use with all methods of irrigation (essential with drip irrigation). 30 years proved! Install IRROMETERS now—new features make the system easier than ever to use.

SEND FOR FREE 20-PAGE INFORMATIVE BOOKLET

IRROMETER CO
BOX 2424 RIVERSIDE, CALIF. 92516
Telephone: (714) 689-1701

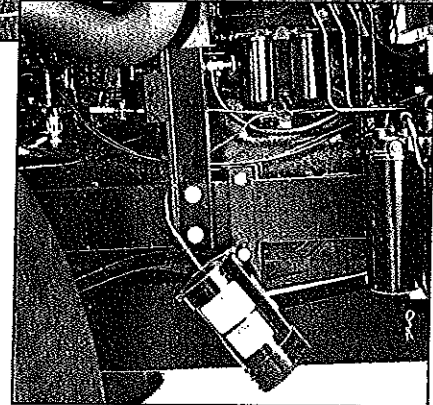
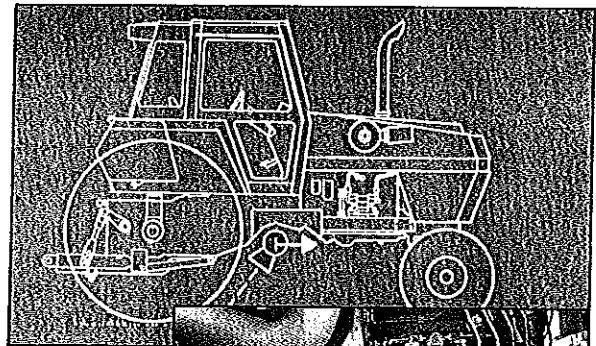
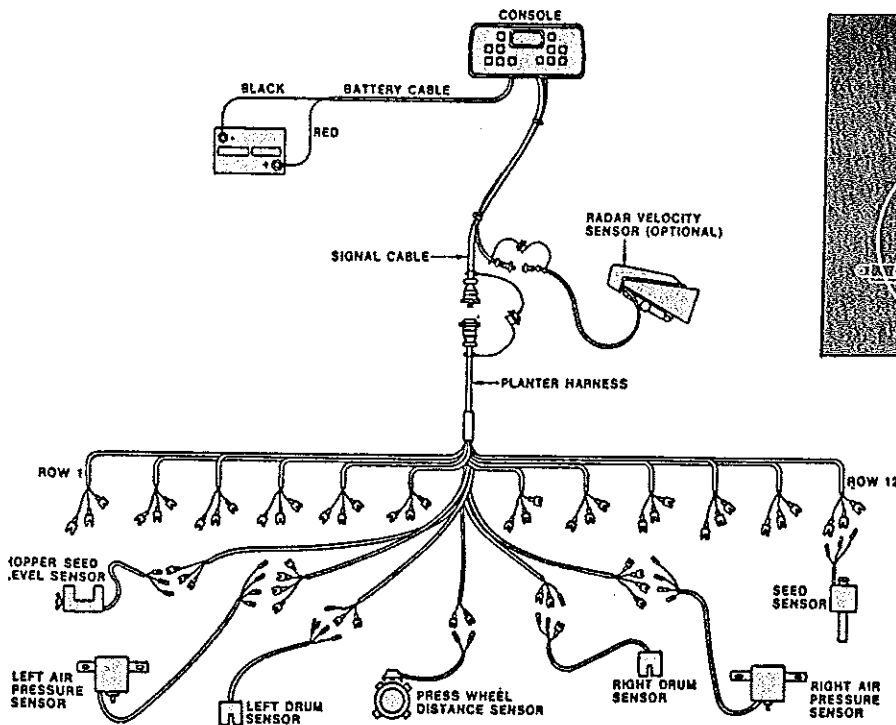

Fiber Optics Extend Sensor's Vision Range

Photoelectric sensor is teamed with optical fibers for monitoring conditions in material handling, packaging, and robotics applications. Compact unit offers a 1-ms response when sensing across distances up to 12 cm, depending on material type and sensing method. When fitted with plastic optics, the sensing distances range from 1.2 cm for a diffuse reflective unit (with steel tubing tip) to 12 cm for a break-beam design. Glass fibers sheathed in silicone rubber, polyester, or spiral steel armor give sensing distances of 8 cm for break-beam types and 3 cm for diffuse reflective units. Omron Electronics Inc., Schaumburg, IL.

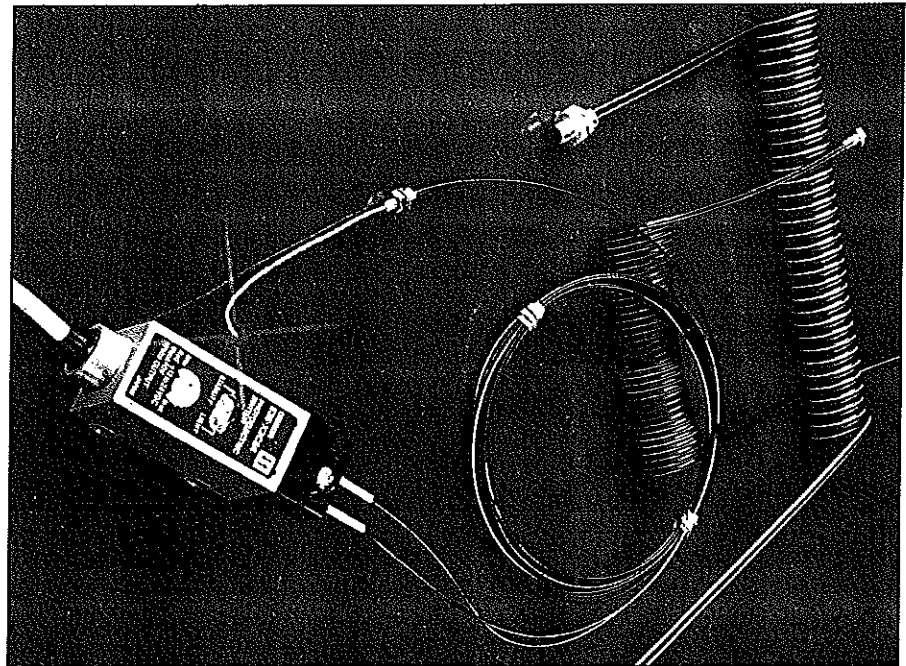

Isolated Diaphragm Meters Corrosive Fluids

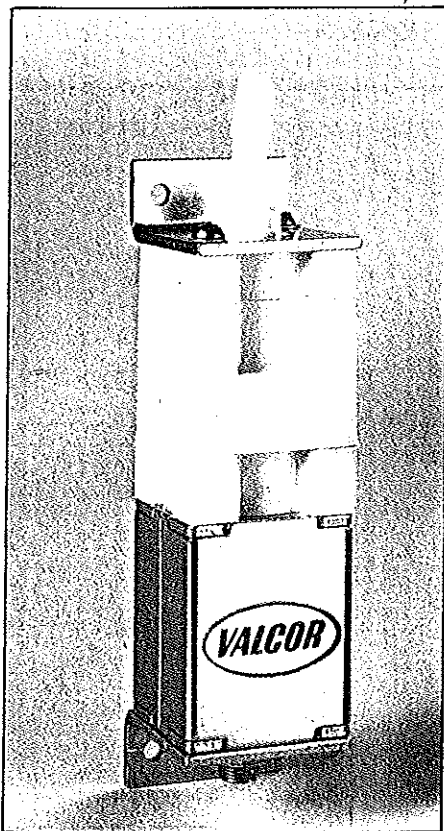

Pump metering precision is maintained by keeping corrosive and high-purity fluids away from the unit's solenoid-actuated diaphragm. Only materials to be contacted by a fluid are the pump's polypropylene and glass body or elastomeric seals. In addition to an isolated diaphragm, the pump has an adjustable solenoid stop and it can operate in either single or multiple-stroke modes. The latter requires a pulse-type signal. Built in both ac and dc models, the pump can deliver 120 strokes/min, dispense up to 198 cc/min of fluid, and provide 2% accuracy. Pumps also resist corrosion and are compatible with many programmable digital controls, reports Valcor Scientific, Div., of Valcor Eng. Corp., Springfield, IL.

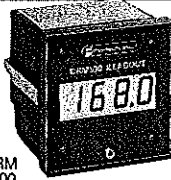

DRM
-100

Flow or Speed or Rate from remote sensor

Calibrated for either GPM, l/min., RPM or any frequency-related rate. Illuminated digital liquid crystal display. 110-130V or 200-260V A.C., 50-400 Hz. U.S. or metric. Send today.

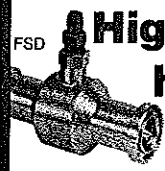

FSD

High pressure heavy duty turbine flow sensor

For production, endurance, heavy-duty testing. Measures oils, fuels, liquids—flow of hydraulic circuits, test stands, machine tools. To 350 GPM. Connections for S.A.E. 6000 PSI 4-bolt flange. Send today for Bulletin 200.



Flo-tech, Inc.

403 S. Washington Blvd., Mundelein, IL 60060
Telephone 312/566-9120 Telex 27-0095

Color-Coded Teeth Meter Granular Chemicals and Plant Seeds

Molded plastic gears meter granular materials into air-driven delivery tubes of chemical applicators built by Gandy Co., Owatonna, MN. Each tube attaches to an air-charged mixing chamber that receives granules from an undershot, gear-like wheel located in a chamber's upper part. All metering wheels mount on a common drive shaft whose speed is controlled by a central unit. Application rate is independent of fluctuations in forward speed. Plastic metering wheels are molded in three color-coded profiles for low, medium, and high rates of application, reports Gandy's E. S. Gandrud.

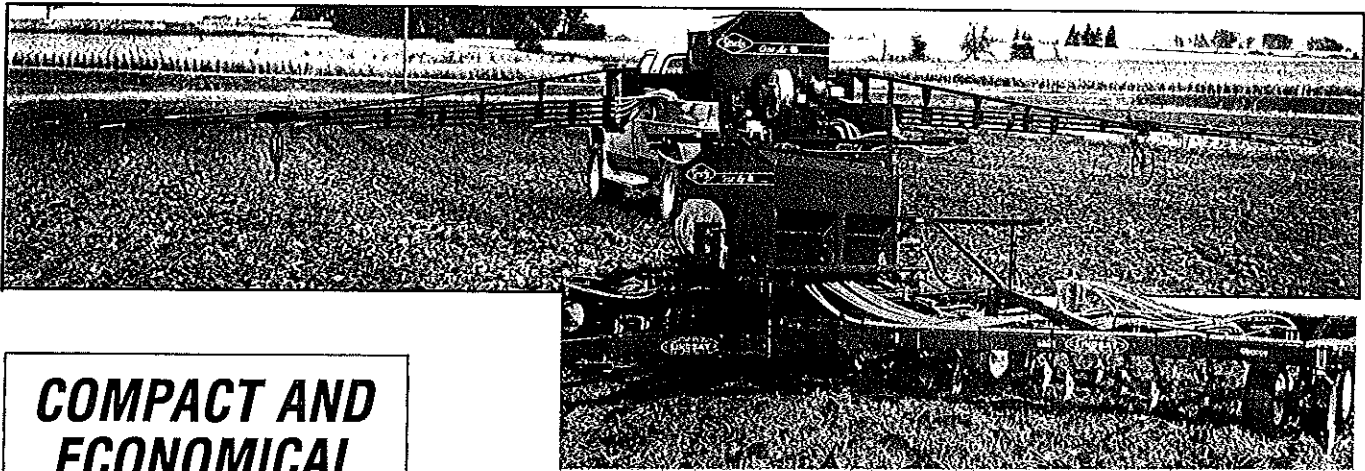
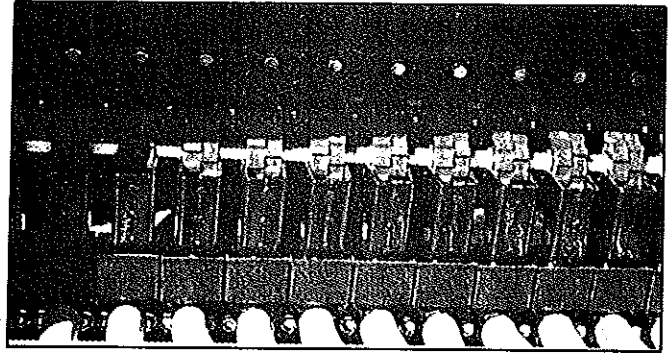

COMPACT AND ECONOMICAL

"A small media filter with a small price tag"

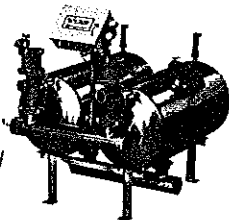

- Stainless Steel
- Quality Construction
- Superior Underdrain

A compact, low-priced system designed for modest filtration volumes.

Flow-Guard's "Flow-Balanced" Underdrain:

- No cake to break
- No plastic
- No need for back-up filters
- Very low maintenance
- Less backwash water

Get Flow-Guard Performance... and Value. CALL TOLL-FREE NOW!

In California (800) 547-7856
U.S. (800) 521-1658

7736 E. Springfield Ave.
Selma, California 93662

 **Fresno Valves & Castings, Inc.**

Remote Control Adjusts Fan Speed

Variable-speed control device adjusts fan speed in response to signals from a sensor located up to 500 ft from the control. An inverted voltage curve is employed to lessen the rate of fan speed increase during the initial stages of temperature rise. This capability is considered especially important when used with supplementary heat sources because an undiscounted rate would waste fuel. Operating on either 115 or 230 V lines, the control handles two 1/3-hp fan motors or three 1/4-hp units, claims Tom Gillis of Gillis Ag Systems Inc., Willmar, MN. Each control is enclosed for protection against dust and moisture.

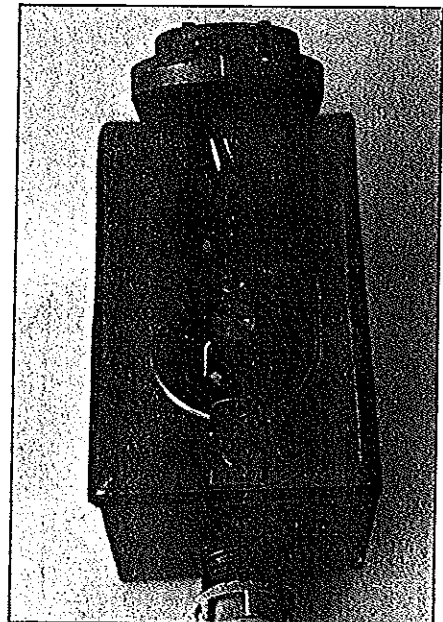

Porous Ceramic Pads Keep Tabs on Water Status

Instrumentation for a computer-based irrigation system consists of several *in-situ* sensors, programmable interface unit, and microprocessor-based controller. Faced with porous ceramic discs, the sensors are buried in the soil to measure its capillary attraction for water. This critical ability to hold or absorb water is known to oppose plant forces for taking up water through a root system. Accordingly, voids in the ceramic pads accept water that dissipates applied thermal energy. Amount of heat dissipated thus correlates directly with the amount of void-filled water, reports Agwatronics Inc., Merced, CA.

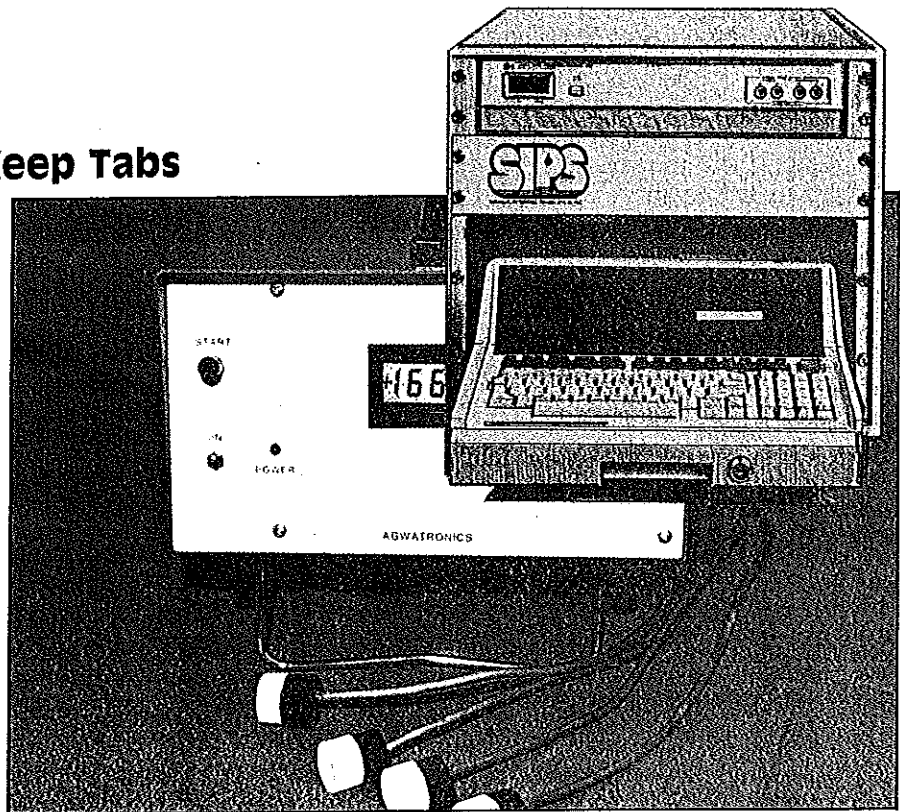

Machined Plastic Enhances Valve Precision

Large-orifice plastic drain valves are machined from polypropylene, polyvinylidene fluoride, or PVC to give tight tolerances and high precision with tough agricultural process chemicals. According to Nacom Industries Inc., Tustin, CA, the pneumatic drain valves handle large flow rates and operate in either air-to-open/air-to-close or spring-return configurations.

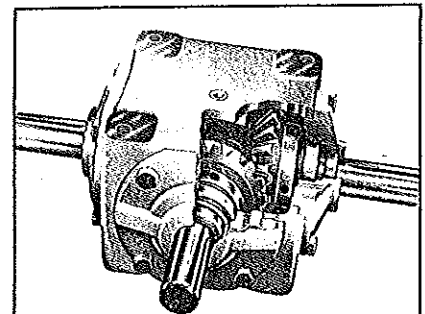
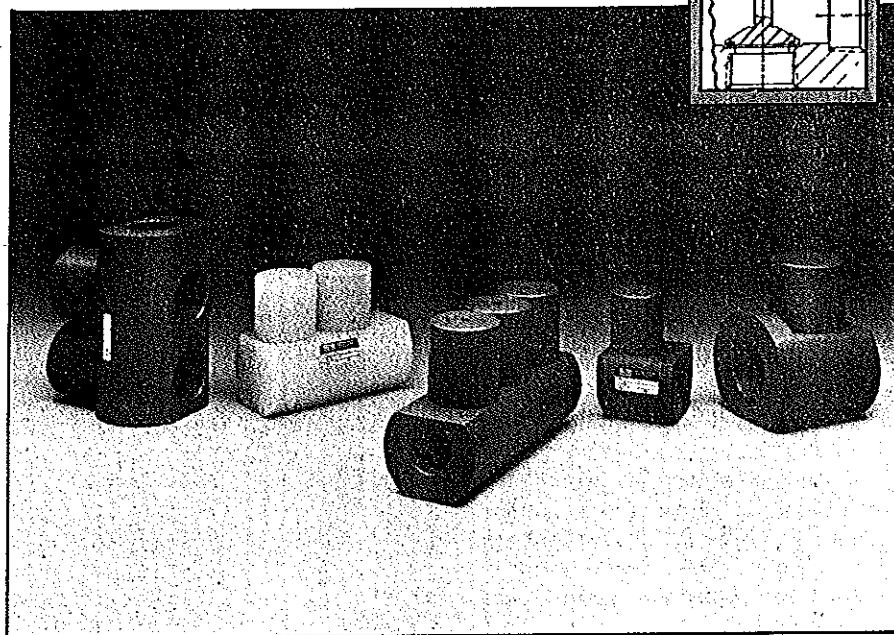
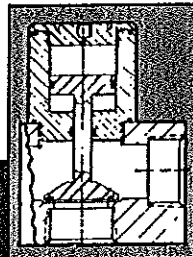

"New Technology In the Old West" ... words we live by at Curtis. If you are needing a right angle bevel gear drive, we can help. We manufacture gearboxes in 9 series with over 25 models and a wide variety of shaft and gear arrangements. Need a custom design? Let a Curtis sales engineer talk to you. More often than not, a modified standard will meet your specifications. Standard or special ... with New Technology and Old West values, Curtis can deliver!

CURTIS
MACHINE COMPANY, Inc.
P O BOX 700 316 227-7164

DODGE CITY, KANSAS 67801

800-835-9166

Foldable ROPS Overcomes Possible Removal Temptation

Tractors equipped with roll-over protective structures (ROPS) must sometimes work in areas where low overhead clearances can preclude equipment access. This vexing situation pits OSHA regulations and ASAE standards versus the reality of operator temptations to remove the ROPS for orchard work and storage situations. It also introduces the likelihood of neglecting to re-install the ROPS, thereby making a tractor operator vulnerable to injury caused by a roll-over accident. This prospect is eliminated by incorporating a fold-over mechanism on the basic ROPS, reports Dan Lockie, chief engineer for Saf-T-Cab Inc., Fresno, CA.

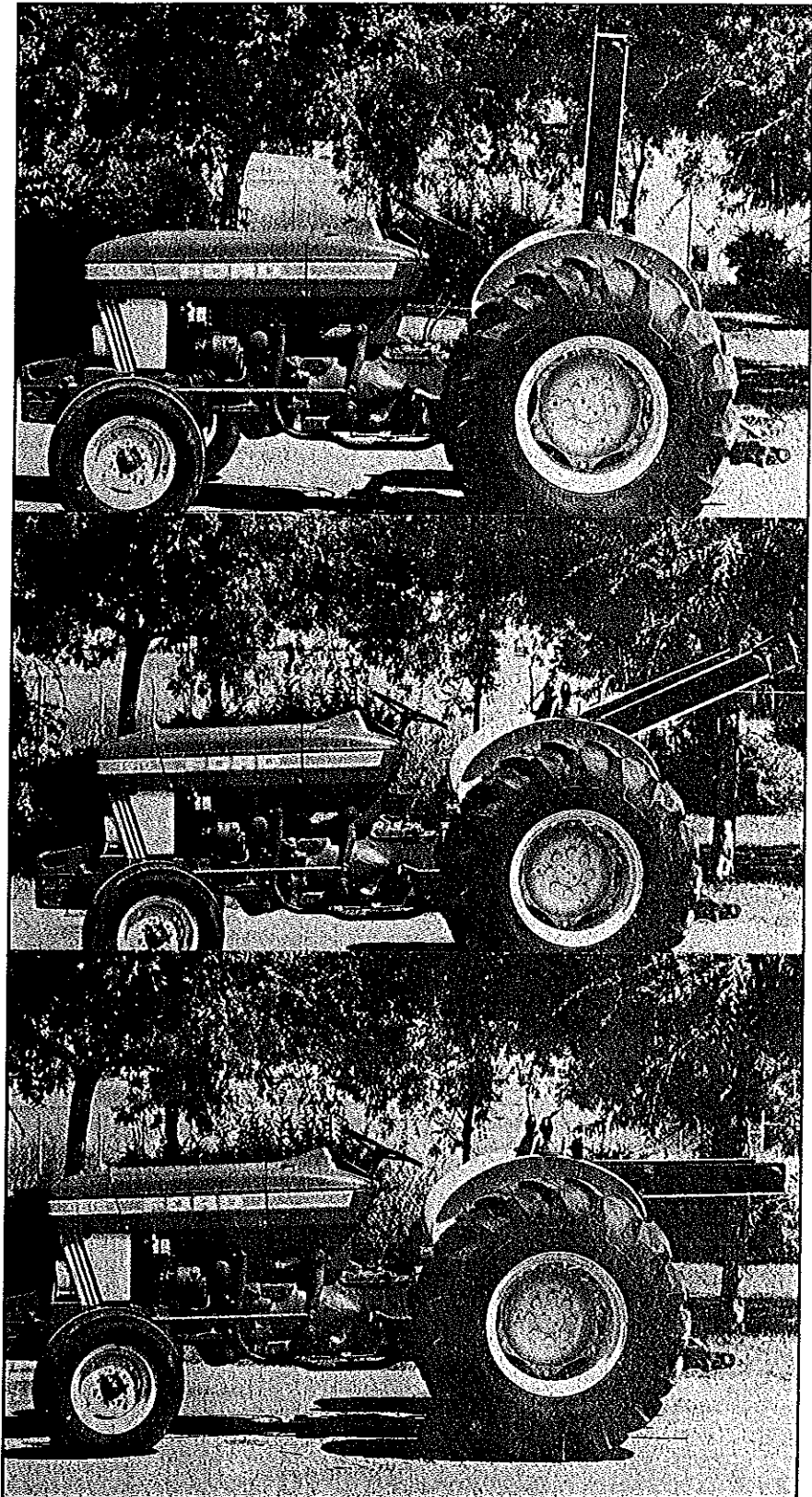

U-Bolts, J-Bolts, Double End Studs and Special Bent Bolts

Alloy Steel | Cut Threads | Rolled Threads | Carbon Steel

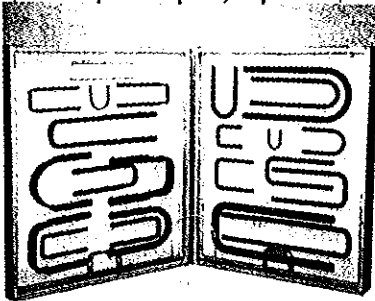

CARBON — Grade 5

7/16" thru 3/4"

ALLOY — Grade 8

7/16" thru 1 1/2"

ALLOY — Grade 8.1

7/16" thru 1"

Cut or roll thread
Heat treating available "In House"

The Massillon Spring & Rivet Corp.
Walnut Road S.W. at State Road 21
Massillon, OH 44646
(216) 832-5066

Fluid-Based Heaters Warm Plants, Animals

Phase-changing fluid picks up thermal energy in a multipass heat exchanger and releases it through radiant panels installed in greenhouses, livestock structures, and food-processing plants. The thermal or isotropic fluid reaches high temperatures at atmospheric pressures, resists corrosion and freezing, and is compatible with most pipework and fittings. Fueled by No. 2 oil or natural gas, a burner atop the heat exchanger is fed preheated air by a bottom-mounted intake fan. Hot gases are produced in a central chamber, then routed along coils of two concentric heat-exchanger rings. The gases make four passes across the heating coils before exiting through an outlet flue. Meanwhile, fluid is heated as it circulates through the outer and inner rings of coils. Fluid heated up to 650 °F is then piped to radiant panels located around structures being heated. After releasing its thermal energy, the fluid returns to the heat exchanger's outer coil ring. Heat-exchanger systems are built in nine sizes with outputs ranging from 0.2 to 13 million Kcal/h (0.8 to 12 million Btu/h), reports Fulton Thermal Corp., Pulaski, NY.

Phase-changing fluid circulates through outer and inner coil rings as hot combusting gases follow tortuous, multipass route along coil sides.

